



R  
E  
G  
I  
T

# DEN LEADER GUIDE



BOY SCOUTS OF AMERICA®

C U B  S C O U T S

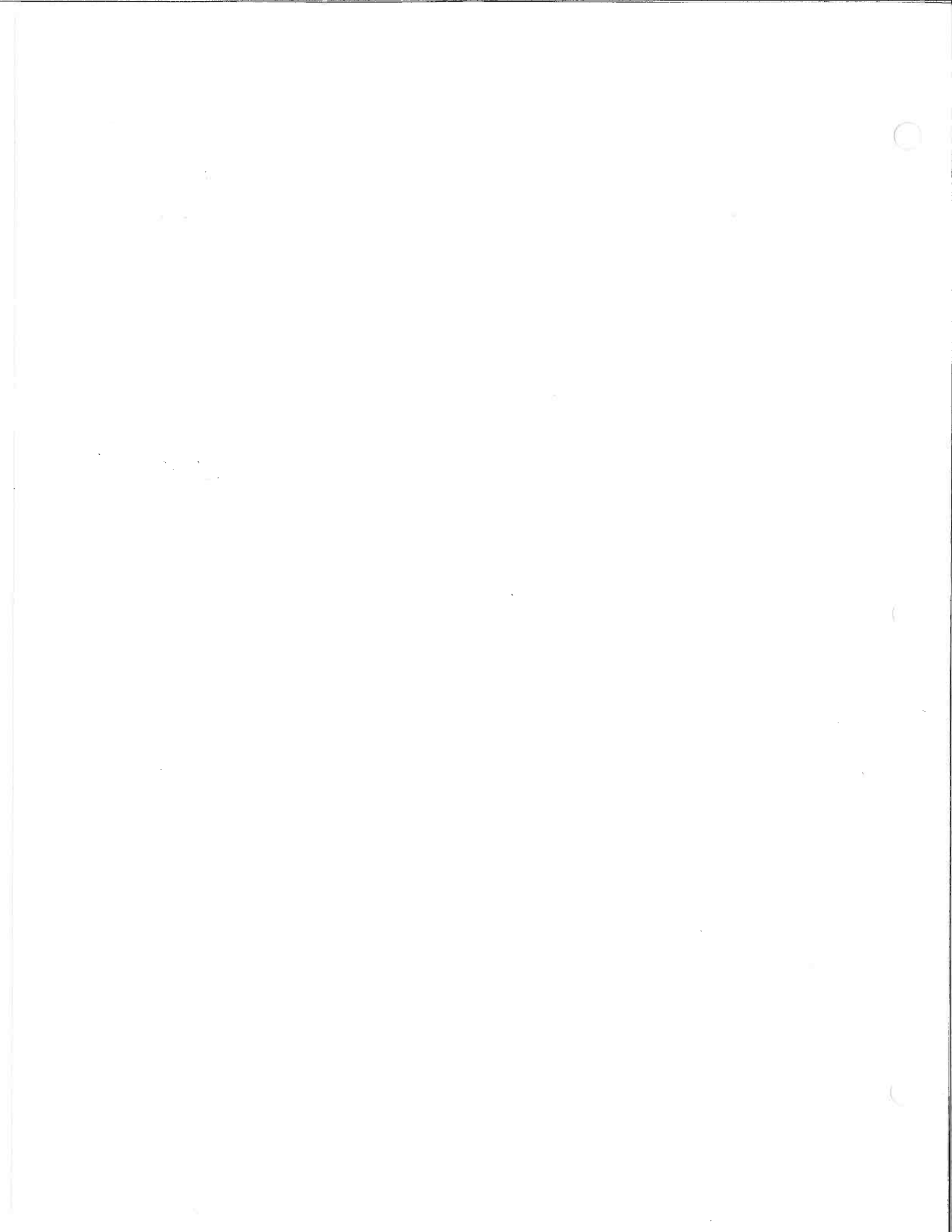



**TIGER**  
**DEN LEADER**  
**GUIDE**



BOY SCOUTS OF AMERICA®

S  
T  
R  
O  
G  
S  
  
B  
U  
C

# A WORD ABOUT YOUTH PROTECTION

Child abuse is a serious problem in our society and, unfortunately, it can occur anywhere, even in Scouting. Because youth safety is of paramount importance to Scouting, the Boy Scouts of America continues to strengthen barriers to abuse through its policies and leadership practices, through education and awareness for youth, parents, and leaders, and through top-level management attention to any reported incidents.

## KEY TO SUCCESS: LEADERSHIP EDUCATION AND TRAINING

Registered leaders are required to complete Youth Protection training within 30 days of registering. Parents, guardians, and any adults working with youth (whether in Scouting or not) are also encouraged to take the training.

To take the training online, go to [www.myscouting.org](http://www.myscouting.org) and establish an account. If you do not yet have your membership number, be sure to return to MyScouting later and enter your number for training record credit.

**The training must be taken every two years to remain current.** If a volunteer does not meet the BSA's Youth Protection training requirement at the time of recharter, the volunteer will not be reregistered.

## BSA YOUTH PROTECTION TRAINING

The BSA created Youth Protection training to address the needs of different age groups as follows.

- **Youth Protection Training for Volunteer Leaders and Parents**—Adults come away with a much clearer awareness of the kinds of abuse, the signs of abuse, and how to respond and report should a situation arise.
- **Youth Protection Guidelines: Training for Adult Venturing Leaders**—Designed to give guidance to the leaders in our teenage coed Venturing program. Supervision and relationship issues have a different focus regarding personal safety with this age group.
- **It Happened to Me**—Developed for Cub Scout-age boys from 6 to 10 years old and their parents. It addresses the four rules of personal safety: Check first, go with a friend, it's your body, and tell.
- **A Time to Tell**—A video for Boy Scout-age boys from 11 to 14 years old—the target group for most molesters. It stresses the three R's of youth protection: Recognize, Resist, and Report.
- **Personal Safety Awareness for Venturing**—Developed for youth ages 13 through 20 in the coeducational Venturing program. It deals with issues pertinent to this age group.

The BSA has Youth Protection policies to protect youth, and these same policies help protect adult volunteers. These and other key policies are addressed in the training:

- **Two-deep leadership is required on all outings.**
- **One-on-one contact between adults and youth members is prohibited.**
- **Privacy of youth is respected.**
- **Separate accommodations for adults and Scouts are required.**
- **Units are responsible to enforce Youth Protection policies.**

To find out more about the Youth Protection policies of the BSA and how to help Scouting keep your family safe, see the *Guide to Safe Scouting* at [www.scouting.org/HealthandSafety/GSS/toc.aspx](http://www.scouting.org/HealthandSafety/GSS/toc.aspx) and the Parent's Guide in any of the Cub Scouting or Boy Scouting handbooks, or go to [www.scouting.org/Training/YouthProtection.aspx](http://www.scouting.org/Training/YouthProtection.aspx).

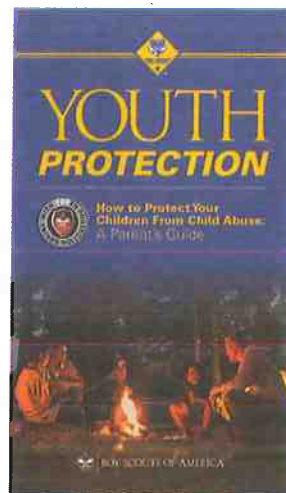

# CONTENTS

◆ <b>Welcome</b> .....	<b>5</b>
◆ <b>An Overview of Cub Scouting</b> .....	<b>5</b>
The Purpose of Cub Scouting .....	5
Cub Scouts: A Positive Place .....	5
One Oath, One Law .....	6
◆ <b>Delivering the Cub Scout Program</b> .....	<b>8</b>
Roles and Responsibilities in Cub Scouting .....	8
The Role of Training .....	10
Resources .....	10
The Cubmaster: Your Key Resource for Program Planning .....	10
Responsibilities to the Boys .....	11
◆ <b>The Cub Scout Ranks and Handbooks</b> .....	<b>12</b>
◆ <b>Advancement</b> .....	<b>13</b>
The First Rank for All Boys—Bobcat .....	16
Tiger Advancement .....	16
◆ <b>Den Meetings</b> .....	<b>20</b>
The Parts of a Den Meeting .....	20
What Are Den Meeting Plans, and How Do I Use Them? .....	21
Character Compass .....	21
Do-at-Home Projects .....	21
Your First Den Meeting .....	22
Den Outings .....	22
◆ <b>Working With Cub Scout-age Boys</b> .....	<b>23</b>
Working With Cub Scouts With Special Needs and Disabilities .....	25
◆ <b>Helpful Hints for Den Leaders</b> .....	<b>27</b>
Planning Your Meetings in Advance .....	27
Den Rules and Code of Conduct .....	27
Duty to God Adventures .....	28
Ceremonies .....	28
Immediate Recognition .....	29
Missed Meetings .....	29

Snacks/Treats .....	29
Den Scrapbook.....	29
Tracking the Adventure .....	30
Success .....	30

**◆ The Tiger Adventure Den Meeting Plans .....31**

Required Adventures .....	31
• Backyard Jungle .....	33
• Games Tigers Play .....	43
• My Family's Duty to God.....	53
• Team Tiger .....	55
• Tiger Bites .....	63
• Tigers in the Wild .....	73
Elective Adventures .....	83
• Curiosity, Intrigue, and Magical Mysteries .....	85
• Earning Your Stripes .....	95
• Family Stories .....	101
• Floats and Boats.....	109
• Good Knights .....	119
• Rolling Tigers .....	125
• Sky Is the Limit.....	131
• Stories in Shapes .....	141
• Tiger-iffic! .....	149
• Tiger: Safe and Smart .....	155
• Tiger Tag .....	163
• Tiger Tales .....	169
• Tiger Theater .....	175

**◆ Appendix .....A-1**

1. Parts of Your Meeting .....	A-7
2. Working With Boys.....	A-25
3. Crafts .....	A-32
4. Games.....	A-36
5. Outdoors .....	A-46
6. Resource Guide for Aquatics Activities.....	A-53
7. Leader Helps.....	A-62
8. Awards .....	A-63
9. Additional Resources .....	A-65

# WELCOME

Welcome, Cub Scout leader! You have chosen to make an important difference in the lives of the boys in your den and pack. With your guidance as their leader, the Cub Scouts will develop character, leadership skills, responsibility, fitness, and a love for fun while learning. Your role as a den leader is a critical one to a boy's success and continued involvement in Cub Scouting. This guide is your key to leading a successful program for the boys in your den. The materials have been developed to help bring to life the adventures promised in the *Tiger Handbook*, *Wolf Handbook*, *Bear Handbook*, and *Webelos Handbook*.

## AN OVERVIEW OF CUB SCOUTING

### THE PURPOSE OF CUB SCOUTING

Cub Scouting is a year-round, family-oriented part of the Boy Scouts of America program designed for boys who are in first through fifth grades (or are 7, 8, 9, and 10 years of age). Parents, leaders, and organizations work together to achieve the 10 purposes of Cub Scouting:

- Character Development
- Spiritual Growth
- Good Citizenship
- Sportsmanship and Fitness
- Family Understanding
- Respectful Relationships
- Personal Achievement
- Friendly Service
- Fun and Adventure
- Preparation for Boy Scouts

All the activities leaders plan and boys enjoy should relate to one or more of these purposes.



### CUB SCOUTS: A POSITIVE PLACE

The Boy Scouts of America emphasizes a positive place in Cub Scouting. Any Cub Scouting activity should take place in a positive atmosphere where boys can feel emotionally secure and find support, not ridicule. Activities should be positive and meaningful and should help support the purpose of the BSA.

# ONE OATH, ONE LAW

Use of the Scout Oath and Scout Law in Cub Scouts and all Scouting programs is designed to help emphasize the unity of the Scouting movement. This helps fulfill Scouting's mission and vision statements, both of which mention the Scout Oath and Scout Law:

**Vision Statement:** The Boy Scouts of America will prepare every eligible youth in America to become a responsible, participating citizen and leader who is guided by the Scout Oath and Law.

**Mission Statement:** The mission of the Boy Scouts of America is to prepare young people to make ethical and moral choices over their lifetimes by instilling in them the values of the Scout Oath and Law.

Scout Oath	Scout Law
On my honor I will do my best To do my duty to God and my country and to obey the Scout Law; To help other people at all times; To keep myself physically strong, mentally awake, and morally straight.	A Scout is trustworthy, loyal, helpful, friendly, courteous, kind, obedient, cheerful, thrifty, brave, clean, and reverent.

## Age-Appropriate Expectations for Learning the Scout Oath and Scout Law

The concepts of the Scout Oath and Scout Law are somewhat abstract, but they are not so difficult that a Cub Scout cannot begin the journey of learning and understanding them. In the beginning of the Cub Scout's journey, don't expect him to memorize. The Scout Oath and Law are printed on the back cover of the handbooks. Use the handbook or a poster as an aid to reciting.

You can also use older Scouts and adults as mentors to help bring your Cub Scouts along at a pace comfortable for their learning needs.

The following descriptions can help you explain the meaning of the Scout Oath and Scout Law to Cub Scouts:

## The Meaning of the Scout Oath

### *ON MY HONOR*

Saying "On my honor" is like saying "I promise." It means that you will do your best to do what the Scout Oath says.

The Scout Oath has three parts. Let's look at what they mean.

### *TO DO MY DUTY TO GOD AND MY COUNTRY AND TO OBEY THE SCOUT LAW*

A duty is something you are expected to do. At home, you might be expected to make up your bed or take out the trash. You also have duties to God and to your country. You do your duty to God by following the teachings of your family and religious leaders. You do your duty to your country by being a good citizen and obeying the law. You also promise to live by the 12 points of the Scout Law, which are described here.

### *TO HELP OTHER PEOPLE AT ALL TIMES*

Many people need help. A friendly smile and a helping hand make life easier for others. By doing good deeds, you make our world a better place.

### *TO KEEP MYSELF PHYSICALLY STRONG, MENTALLY AWAKE, AND MORALLY STRAIGHT*

The last part of the Scout Oath is about taking care of yourself. You stay physically strong when you eat the right foods and get plenty of exercise. You stay mentally awake when you work hard in school, learn all you can, and ask questions. You stay morally straight when you do the right thing and live your life with honesty.



## The Meaning of the Scout Law

The Scout Law has 12 points. Each one is a goal you should do your best to achieve.

A Scout is **TRUSTWORTHY**.

A Scout tells the truth and keeps his promises. People can depend on him.

A Scout is **LOYAL**.

A Scout is true to his family, friends, Scout leaders, school, and country.

A Scout is **HELPFUL**.

A Scout volunteers to help others without expecting a reward.

A Scout is **FRIENDLY**.

A Scout is a friend to everyone, even people who are very different from him.

A Scout is **COURTEOUS**.

A Scout is polite to everyone and always uses good manners.

A Scout is **KIND**.

A Scout treats others as he wants to be treated. He never harms or kills any living thing without good reason.

A Scout is **OBEDIENT**.

A Scout follows the rules of his family, school, and pack. He obeys the laws of his community and country.

A Scout is **CHEERFUL**.

A Scout looks for the bright side of life. He cheerfully does tasks that come his way. He tries to make others happy.

A Scout is **THRIFTY**.

A Scout works to pay his way. He uses time, property, and natural resources wisely.

A Scout is **BRAVE**.

A Scout can face danger even if he is afraid. He stands for what is right even if others laugh at him.

A Scout is **CLEAN**.

A Scout keeps his body and mind fit. He helps keep his home and community clean.

A Scout is **REVERENT**.

A Scout is reverent toward God. He is faithful in his religious duties. He respects the beliefs of others.

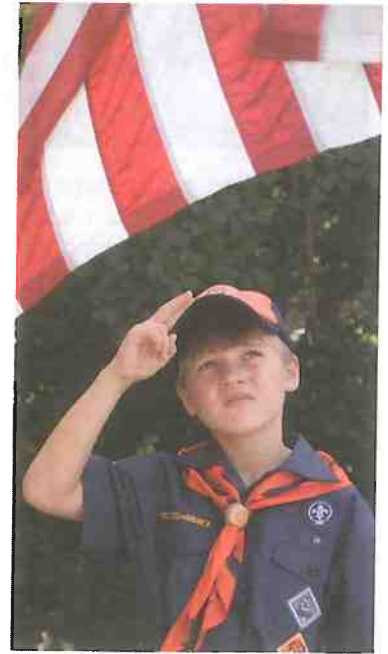

## ◆ DEN CHIEF

The den chief is a Boy Scout, Varsity Scout, Venturer, or Sea Scout who serves as an activities assistant at Wolf, Bear, or Webelos Scout den meetings. He (or she, if you work with a female Venturer or Sea Scout) can serve as a positive role model for Cub Scouts as they look toward joining the Boy Scout program and beyond. The Scoutmaster from a local troop may be able to help identify a den chief.

## THE ROLE OF TRAINING

Core to succeeding with these responsibilities is the concept that every Cub Scout deserves a trained leader. Being a trained leader helps you deliver the program in a way that is effective and efficient with a focus on the core objectives for the boy. Becoming a trained leader requires completion of the following training:

- Youth Protection
- Leader Position-Specific

Both trainings are available online at [www.myscouting.org](http://www.myscouting.org) and as an in-person training through your local council service center. Consult with your pack trainer or visit [www.myscouting.org](http://www.myscouting.org) for training options. Leaders who have completed these two trainings qualify to wear the trained leader strip.

## RESOURCES

This *Den Leader Guide* is designed to be self-contained, including all the information you will need to run your den meetings. However there are additional resources which add character and context to the Cub Scout leader's experience. As you gain more experience you should consider having the following in your personal Cub Scouting library. Many packs have pack libraries as well for sharing among their pack leadership.

- *Cub Scout Leader Book* (No. 33221)
- *Leader How-To Book* (No. 33832)
- *Ceremonies for Dens and Packs* (No. 33212)
- *Tiger Handbook* (No. 34713)
- *Group Meeting Sparklers* (No. 33122)
- *Cub Scout Songbook* (No. 33222)

## THE CUBMASTER: YOUR KEY RESOURCE FOR PROGRAM PLANNING

You will work closely with the Cubmaster to deliver the Cub Scout program to the boys in your den. The Cubmaster works as the program leader for the pack. In addition to working with den leaders, he or she will lead the pack program at your monthly pack meeting. Some of the ways you and the Cubmaster will collaborate include the following:

- Work together to plan and help carry out the Cub Scout program in the pack according to the policies of the BSA. This includes leading the monthly pack meeting with the help of other leaders.
- With the pack committee, develop and execute a year-round recruitment plan for recruiting boys into Cub Scouting.
- Acquire and use the appropriate and available Scouting literature, including the den leader guide for each program level and the pack meeting plans available online at [www.scouting.org](http://www.scouting.org).
- See that the pack program, leaders, and Cub Scouts positively reflect the interests and objectives of the chartered organization and the BSA.
- Encourage movement into a Boy Scout troop by establishing and maintaining good relationships with Boy Scout troops; this is especially important for Webelos den leaders. Your pack may have an assistant Cubmaster whose primary responsibility is to support transition from Cub Scouting into Boy Scouting.

- Together, maintain good relationships with parents and guardians. Seek their support, and include them in activities.
- Work collaboratively to ensure that Cub Scouts receive a quality, year-round program filled with fun and activities that qualify the dens and pack for the National Summertime Pack Award.
- Participate with the Cubmaster and the pack committee chair in the pack's annual program planning conference and the monthly pack leaders' meetings.
- Work as a team with the pack committee chair to cultivate, educate, and motivate all pack leaders and parents or guardians in Cub Scouting.
- Work together to conduct impressive advancement, recognition, and graduation ceremonies. For Webelos ceremonies, involve Scoutmasters and other Boy Scout and Scout leaders.
- Bring families together at joint activities for Webelos dens (or packs) and Boy Scout troops.
- Support the policies of the BSA.

In addition to coaching and supporting den leaders, the Cubmaster will help coordinate den activities that will take place during the pack meeting. Many of the advancement requirements that are related to outdoor adventure and leadership development require the boys in each den to work with each other during pack meetings. The Cubmaster will help to organize those activities.

## RESPONSIBILITIES TO THE BOYS

All Cub Scout leaders have certain responsibilities to the boys in Cub Scouts. Each leader should:

- Respect boys' rights as individuals and treat them as such. In addition to common-sense approaches this means that all parents/guardians should have reviewed *How to Protect Your Children From Child Abuse: A Parent's Guide*, and all youth leaders must have taken the BSA's Youth Protection training.
- See that boys find the excitement, fun, and adventure that they expected when they joined Cub Scouting.
- Provide enthusiasm, encouragement, and praise for boys' efforts and achievements.
- Develop among the boys a feeling of togetherness and team spirit that gives them security and pride.
- Provide opportunities for boys to experience new dimensions in their world.

# THE CUB SCOUT RANKS AND HANDBOOKS

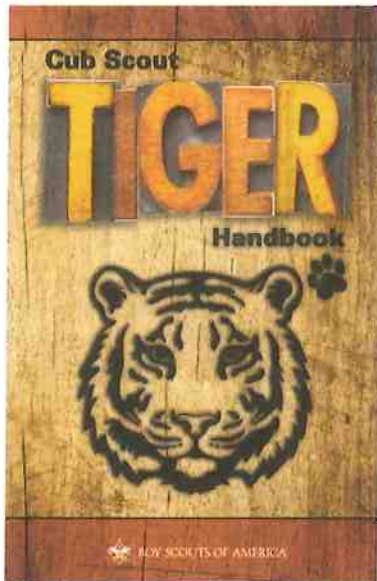

A boy who is 7 years old or is in the first grade is a Tiger, and his adventures are found in the *Tiger Handbook*.

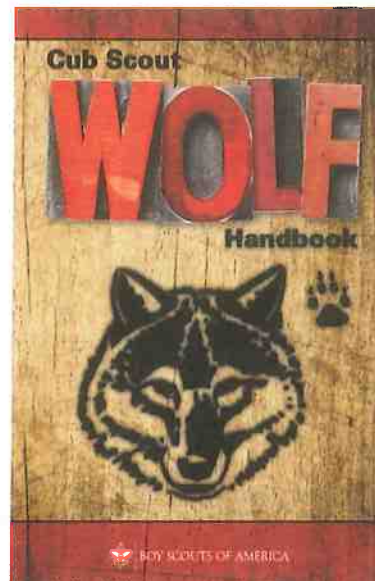

A boy who is 8 years old or is in the second grade is a Wolf, and his adventures are found in the *Wolf Handbook*.

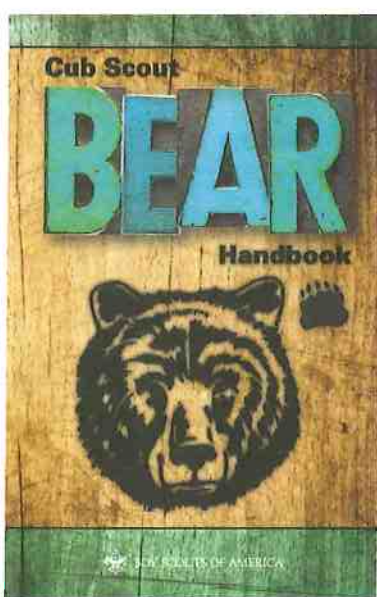

A boy who is 9 years old or is in the third grade is a Bear, and his adventures are found in the *Bear Handbook*.

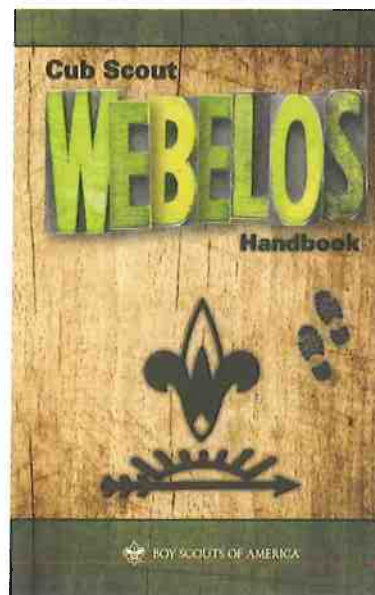

A boy who is 10 and 11 years old or is in the fourth or fifth grade is a Webelos Scout, and his adventures are found in the *Webelos Handbook*.

The den meeting plans are written to help a boy earn the adventure requirements in his handbook. A den leader is strongly encouraged to have the handbook for the den he or she is leading as well, to be able to follow along with the boys and review for den meeting planning.

# ADVANCEMENT

## ◆ CUB SCOUT ADVANCEMENT FOR RANK BADGE

Advancement is one of the methods we use to achieve Scouting's aims and its desired outcomes. As boys earn the ranks of Bobcat, Tiger, Wolf, Bear, Webelos, and the Arrow of Light, they achieve important goals in developing skills and favorable dispositions related to personal fitness, good character, participatory citizenship, outdoor skills and awareness, and leadership development. Each level of the program from Tiger to Arrow of Light is designed to achieve these goals through a series of developmentally-appropriate and fun adventures.

## ◆ RECOGNITION PROCESS

No boy wants to wait several months to be recognized for his hard work. The Cub Scout program recognizes completion of intermediate steps leading to rank advancement by awarding an immediate recognition device.

Advancement gives boys a means of measuring their progress. Credit is given to the Cub Scout for each requirement when the adult partner (Tigers), den leader, and/or Webelos adventure pin counselor is satisfied that the boy has done his best.

Ensuring that boys are recognized immediately and publicly for their efforts is an important part of the advancement process. **No boy should have to wait for more than two weeks to receive a device and be recognized for his accomplishments.** Your pack may approach this in a variety of ways:

- The den leader may provide the recognition device (a pin for boys working on Webelos and Arrow of Light adventures or an adventure loop for boys working on Tiger, Wolf, and Bear adventures) at the final meeting when the Cub Scouts complete the adventure. At the following pack meeting, the boys would then receive a certificate during a brief ceremony. (Full-size and pocket certificates are available from your local Scout shop.)
- The pack may provide certificates for den leaders to award when the boys complete the adventure and then present the adventure loops and pins at the next pack meeting.

Packs are encouraged to find a method that works well for the boys in the pack, guided by principles that recognition is both *immediate* to encourage the boys and *public* to celebrate their success.

Advancement provides a satisfying means of recognizing boys for their progress. Boys have a ladder to climb, with recognition at each step. Presenting awards to boys in meaningful ceremonies to recognize their accomplishments is a principle of advancement. Advancement is not competition among boys. Each Cub Scout is encouraged to advance steadily and purposefully, setting his own goals with guidance from his family and leaders. Measurement for satisfying requirements is "Do Your Best," and that level can be different for each boy.



## ◆ HOW THE ADVANCEMENT PROGRAM WORKS

The success of the advancement program depends entirely on how Cub Scout leaders and parents apply it. Careful research has gone into developing the advancement program, but den and pack leaders and families make advancement work in the dens, in the home, and, most importantly, in the lives of boys.

### Goals of the Advancement Program

When implemented correctly, the advancement program will:

- Help build a boy's self-esteem.
- Help build his self-reliance as he discovers his increasing abilities.
- Give a boy the positive recognition that he needs.
- Bring a boy and his family closer through the advancement activities that family members enjoy together.

### The Den Leader

The den leader has the following responsibilities related to advancement.

1. Stimulate interest in advancement by delivering fun and exciting den meetings using the *Tiger Den Leader Guide* and by providing opportunities for boys to work on advancement requirements in den meetings.
2. Plan meetings that support the advancement program. The den chief or Webelos den chief can help.
3. Help parents and adult partners understand the advancement plan and their role in promoting advancement. Make sure returning parents understand how the advancement process works at each program level.
4. Keep accurate records of requirements that boys complete. Promptly provide the pack leadership with the advancement records so boys can be recognized at the next pack meeting.
5. Identify boys who are not advancing and find out why. This could indicate a weakness in the den or pack program or something you could do to help these boys catch up to their peers.
6. Provide reinforcement for and recognition of advancement at den meetings. These can include advancement charts, den doodles, and immediate recognition items.
7. Make sure that impressive advancement ceremonies and graduation ceremonies are conducted at the pack meetings. For the Arrow of Light rank, involve the Scoutmaster and the troop's youth leaders.



### The Cubmaster

The Cubmaster has these responsibilities related to advancement.

1. Provide a quality year-round program full of action and fun that appeals to boys. See that den and pack activities are planned so that completing required and elective adventures for all levels is a natural outcome of the month of fun.
2. Guide den leaders in the use of the *Tiger Den Leader Guide* to help organize and deliver each meeting's program for each level of programming.
3. Work with den leaders to coordinate den activities at pack meetings that support the use of the Cub Scout adventure program materials.
4. Provide advancement reinforcement at the pack meeting, such as colorful and exciting induction, advancement, and graduation ceremonies. Encourage displays of advancement charts and den doodles at pack meetings.
5. Ensure that boys who have earned awards receive them at the next pack meeting. Don't let boys get discouraged by having to wait for recognition.



6. Make sure that den leaders are trained and know how to use the advancement program effectively.
7. See that advancement standards are maintained. Every boy should do his best to complete the requirements as presented in the program.
8. Coordinate with the pack committee to ensure that accurate advancement records are kept. Follow up on boys who are not advancing and find out why.

### The Pack Committee

Pack committee members have these responsibilities related to advancement.

1. Help train leaders and adult partners or family members in the proper use of the advancement program.
2. Ensure that den leaders have program resource materials such as den leader guides and advancement charts to support program delivery.
3. Collect den advancement reports at each monthly pack leaders' meeting. Complete the multipart Advancement Report to purchase awards from the local council service center. See that badges are presented at the next pack meeting.
4. Help plan advancement and graduation ceremonies for the pack meeting.
5. Help build and/or secure equipment for use in meaningful advancement ceremonies.



### How Fast Should a Boy Advance?

A boy's approach to advancement progress will depend on two factors:

- His own motivation for learning new skills, the encouragement and help he gets from his family, and his need for recognition
- The den leader's preparation for and presentation of advancement activities in the den meetings

The den meeting plans outlined in the *Tiger Den Leader Guide* provide program opportunities that are generally delivered as two den meetings and an outing each month. This will provide opportunities for boys to advance. A year-round program is composed of required adventures (that will lead to rank advancement) and elective adventures (which contribute to rank advancement and provide program enrichment).

If a boy cannot attend all meetings, the den leader should help that boy and his family complete the missed activities.

**Although many packs target their blue and gold banquet for awarding the boys' new badge of rank, there is no requirement to advance by an arbitrary date such as a blue and gold banquet.**

#### Advancement Checklist

- Do the Cubmaster and pack committee give den leaders and families guidance in using the advancement program effectively?
- Do family members understand their part in the advancement program? Are they using achievements, electives, and activity badges to suggest activities for the boy's free time?
- Do den leaders talk to parents about boys who are not advancing?
- Do den leaders implement the required den meeting plans leading to advancement as outlined in the *Tiger Den Leader Guide* and, when necessary, have advancement work completed at home?
- Are accurate advancement records kept in the dens and the pack?
- Do boys receive prompt recognition?
- Do pack advancement ceremonies create an incentive for advancement?
- Are wall charts and den doodles used in den and pack meetings?
- Does the pack have an advancement ladder or chart?

# THE FIRST RANK FOR ALL BOYS—BOBCAT

The Bobcat rank is the first badge awarded a new Cub Scout. As a new member, he may work on his Bobcat rank requirements while simultaneously working on his next rank as well. He cannot, however, receive his Tiger, Wolf, Bear, Webelos, or Arrow of Light badge until he has completed Bobcat requirements and earned his Bobcat badge. Boys can normally earn their Bobcat badge well within the first month of becoming a new Cub Scout.

You as his leader can help! Practice the requirements with him and the other boys in your den meetings, and encourage them to work on the requirements with their families also. Requirement 7 is a home-based requirement. The requirements are found in each of the youth handbooks as well as listed below:

## Bobcat Requirements

1. Learn and say the Scout Oath, with help if needed.
2. Learn and say the Scout Law, with help if needed.
3. Show the Cub Scout sign. Tell what it means.
4. Show the Cub Scout handshake. Tell what it means.
5. Say the Cub Scout motto. Tell what it means.
6. Show the Cub Scout salute. Tell what it means.
7. With your parent or guardian, complete the exercises in the pamphlet *How to Protect Your Children From Child Abuse: A Parent's Guide*.



# TIGER ADVANCEMENT

Tiger Scouts work toward the Tiger rank. The Tiger rank is earned by completing seven adventures as described below. Although participation with an adult partner is required for all Tiger awards, recognition items are for boys only.

1. Complete each of the following Tiger required adventures with your den or family:
  - a. Backyard Jungle
  - b. Games Tigers Play
  - c. My Family's Duty to God
  - d. Team Tiger
  - e. Tiger Bites
  - f. Tigers in the Wild
2. Complete one Tiger elective adventure of your den or family's choosing.
3. With your parent or adult partner, complete the exercises in the pamphlet *How to Protect Your Children From Child Abuse: A Parent's Guide*, and earn the Cyber Chip award for your age.\*



\*If your family does not have Internet access at home AND you do not have ready Internet access at school or another public place or via a mobile device, the Cyber Chip portion of this requirement may be waived by your parent or adult partner.

For each adventure, the Tiger and adult partner team must complete the requirements as outlined in the *Tiger Cub Scout Handbook*.

Requirement 7 of Bobcat and requirement 3 of Tiger are identical. If a Cub Scout earns his Bobcat rank during the same year that he begins working on his Tiger rank, he needs to complete the requirement only one time.

The adult partner acknowledges the completion of each achievement part by signing the boy's handbook (Akela's OK). The den leader also signs each boy's handbook (Den Leader's OK) and records progress in the den's advancement records. The Tiger Scouts also keep track of their own advancement using the Adventure Tracking section in the back of their handbooks, and under the guidance of the den leader, they can also keep a record of their individual progress on a den advancement chart and den doodle.



The pack should encourage each den to deliver a year-round program, drawing from both required adventures to support rank advancement and elective adventures to support program enrichment. Elective adventures may be earned during den activities, by a boy with the participation of his family, and during council and district sponsored program opportunities. There is no required order in which adventures must be earned. The sequence is left to the discretion of the den leader and Cubmaster.

After a boy earns the Tiger badge, he will continue to meet with his den, working on additional elective adventures until he completes first grade (or turns 8 years old) and becomes a Wolf Scout.

	Adventure Loop	Tiger		Adventure Loop	Tiger
Required		Backyard Jungle	Elective		Floats and Boats
Required		Games Tigers Play	Elective		Good Knights
Required		My Family's Duty to God	Elective		Rolling Tigers
Required		Team Tiger	Elective		Sky Is the Limit
Required		Tiger Bites	Elective		Stories in Shapes
Required		Tigers in the Wild	Elective		Tiger-iffic!
Scout or Den Choice		(1) Elective adventure of choice	Elective		Tiger: Safe and Smart
	Adventure Loop	Tiger	Elective		Tiger Tag
Elective		Curiosity, Intrigue, and Magical Mysteries	Elective		Tiger Tales
Elective		Earning Your Stripes	Elective		Tiger Theater
Elective		Family Stories			

After a boy has completed all the requirements for the Tiger rank, he should receive the Tiger badge from his adult partner at the next pack meeting. This is an important milestone, so the ceremony should be suitably impressive. The Tiger badge is sewn on the left pocket of the uniform shirt in the bottom position.

A Scout may complete as many elective adventures as his ambition and time available allow. He is entitled to wear each of the adventure loops he earns on his official Cub Scout belt.

## ◆ PLANNING YOUR MEETINGS

As you plan your den's program for the year, there are a few important points to consider.

- **Required adventures.** These adventures are required to advance from rank to rank.
- **Elective adventures.** These add to the fun and adventure of Cub Scouting. One elective adventure is required to earn the Tiger, Wolf, and Bear ranks. Two are required to earn the Webelos rank, and three are required for boys to earn the Arrow of Light rank.
- **Coordinating your planning.** Some of the adventures require coordination with other dens. A pack meeting is an ideal place to do this. There are some suggestions made in the *Cub Scout Leader Book*, but however your dens and pack wish to do this, work together with the other leaders in your pack to build this into your annual program. When working out your annual program plan, seek to deliver an entire year of fun programming. It is important to seek input from the Cub Scouts in the den to find out which adventures they would like to explore with the members of the den. Elective adventures that are not selected may be earned by boys at home, working with their families.
- **Audience for requirements.** Many of the requirements state that a Scout should demonstrate a new skill or share something they have learned with other boys during a den meeting. We all need to recognize that not all Scouts are able to make each meeting. While we recognize that the best approach is to carry out sharing tasks in a den setting, it may be necessary to allow Cub Scouts to share what they have learned while working on Cub Scout advancement requirements in other settings, such as in front of their family.
- The duty to God adventures are primarily done with the family and, for some dens, may not be included as part of the den meeting planning. If that is the case, notify families that they will need to help their Cub Scout complete the adventure at home. See page 28 for more information regarding the duty to God adventures.

Read through the Tiger adventures, and give some thought to which adventures will work the best for your location and climate. Write in the adventures you will use and the corresponding month that will work best. Check with your Cubmaster to see if some adventures need to be coordinated with other dens or for upcoming pack meetings.

Important: When planning, keep in mind that six required adventures and one elective adventure are required for Tiger, Wolf, and Bear advancement. The Webelos rank requires five required adventures and two elective adventures. The Arrow of Light rank requires four required adventures and three elective adventures. When planning your annual program, keep those advancement requirements in mind. Rank adventures can be awarded at any time within the boy's rank year by age or grade. Once a boy has moved (graduated) to his next level den, HE MAY NOT EARN THE RANK OF HIS PREVIOUS DEN LEVEL.

## DEN ANNUAL ADVENTURE PLAN

Month	Adventure
August	
September	
October	
November	
December	
January	
February	
March	
April	
May	
June	
July	

# DEN MEETINGS

Along with the Cub Scout's family, the den meeting is critical to the Cub Scout's success and enjoyment of the Cub Scouting program. It is in and through the den that the boy makes social connections, has fun, and completes his advancement. Den meetings that are fun, organized, and interesting make a great environment for the boys.

In the den meeting plan section of this resource, you will find that each den meeting follows the same seven parts outlined below.

## THE PARTS OF A DEN MEETING

### PREPARATION AND MATERIALS NEEDED

This section of the den meeting alerts you to what you need to have on hand to lead the den meeting. It may also alert you to arrangements you need to make in advance such as scheduling a meeting with a guest or arranging the logistics for an outing.

Read the pages in the handbook for each new adventure before you start to work on it. The handbook provides background information, instructions, or suggestions for many activities. Encourage Scouts to bring their handbooks to each meeting.

### GATHERING

This part of the meeting is designed to keep boys occupied and prepare them for the meeting as the rest of the den arrives. Some den meeting plans reference specific suggestions that are related to the meeting's theme. Other den meeting plans will draw your attention to the Appendix, where many different ideas are offered to help organize this part of the meeting. Leading the Cub Scouts in a 10–15 minute active game makes for a great Gathering activity, helping to jump-start the meeting and allowing boys to release energy and improve focus.

### OPENING

The opening is usually ceremonial in nature, and it often connects with patriotic practices, such as flag ceremonies, or connects the boys with the ideas of Scouting, such as a shared recitation of the Scout Oath or Law. This can be an appropriate time for a prayer. The opening tells the boys that the meeting has begun.

### TALK TIME

This is where the business items of the den take place. Business items can include any of the following:

- Dues
- Recording advancement (a second adult)
- Notification/reminder for upcoming trips or tours
- Notification/flier for upcoming events
- Introducing a new adventure
- Meeting information: Telling Cub Scouts what to expect at this meeting
- Setting the groundwork for future advancement
- Notes for the upcoming pack meeting

Talk Time should be brief so you and the boys can get right to the fun at the heart of the meeting. Some den meeting plans offer specific suggestions; in other cases, you may only be addressing the standard items. Some adventure requirements direct Cub Scouts to share what they accomplished during the week with their den; this is a great time to do that.

## ACTIVITIES

This is the heart of the adventure in each den meeting. This is where fun and learning take place, and the boy completes most of his advancement requirements. Detailed guidelines are provided to lead each of the activities.

## CLOSING

The Closing provides a ceremonial moment to wrap up the meeting. The Closing, especially as boys grow older and more mature, is often led by the denner, the youth leader of the Cub Scout den.

## AFTER THE MEETING

This is a place to review the success of the meeting, to note the need to follow up with additional parts of the meeting, to communicate with parents, and to record what was completed during the den meeting. Many dens enjoy refreshments or snacks at the close of the den meeting. If you do serve a snack, set an example of healthy eating and offer a nutritious snack of fruits or vegetables. And good Scouts always tidy up at the close of the meeting.

## WHAT ARE DEN MEETING PLANS, AND HOW DO I USE THEM?

The den meeting plans are your guide to bringing the adventures of advancement to life for your den of boys. These plans will, if followed, help a boy advance in rank as he experiences all the FUN of Cub Scouting. It takes 45–60 minutes to read through and prepare for each den meeting.

The plans are developed around the following:

- Two to three den meetings per month in addition to the pack meeting or other pack activities.
- If a plan consists of three den meetings, one of those meetings is usually designed to be an outing. The outing may take place at the beginning, middle, or end of the adventure, so be sure to read through each of the den meeting plans for each adventure before beginning. Outings are very important to the boy and to his experience in Scouting!
- The plans follow the parts of the den meeting structure listed above.

## CHARACTER COMPASS



In the den meeting plans you will notice this icon. The adventures you are planning for the monthly meetings have an association with one or more points of the Scout Law. As you read through the plans and the Cub Scout handbook for the adventure, be aware of the point of the Law emphasis and how you may be able to help teach it to the boys. These icons are to be brought about naturally and subtly within the adventure and are by no means meant to be “drilled” into your meeting plan. That’s one of the wonderful things that happens in Scouting—we teach character development through our adventures and advancement while the boy barely notices!

## DO-AT-HOME PROJECTS



Do-at-Home Projects are activities that boys and/or their parents are to do outside den meetings. Projects should be assigned (usually during the Closing). They may be assignments in preparation for the next den meeting plan, or they may be part of a requirement that you will need to then verify at the next den meeting as having been completed.

## YOUR FIRST DEN MEETING

The tone you set at the first meeting will determine, to a large extent, the success of your year. Key to setting the right tone is to consider the following:

- Wear your adult uniform to all meetings, and remind boys to wear their uniforms.
- Be completely organized before the start of the meeting.
- If you are new to running meetings like this, it is easier to think of it as seven short activities (see the parts of the den meeting section) rather than a single long event.
- Explain clearly to the boys the behavioral expectations. You may wish to use the “good conduct candle” approach (see this guide’s Appendix) and develop a den code of conduct. This can be hand-written on poster board, or a den code of conduct poster may be purchased at your local council Scout Shop (No. 32068). Be consistent, friendly, but firm with the boys.
- Explain that Scouts should bring their handbooks to each meeting.

If you are a new den leader, ask the assistant den leader(s) to arrive at least 15 minutes before the starting time of the meeting. He or she can help you with final preparations before the rest of the boys arrive. It is a good idea to have something constructive for boys who arrive early to do (known as the “Gathering” part of the den meeting plan) while you are making final preparation for den meetings; you might even have them help set up some parts of the meeting.

A snack at den meetings is optional. If you do serve a snack, offer fruits or vegetables to set an example of healthy eating. Be aware of any food allergies of den members and communicate these to adult partners who may be assisting with the snacks.



To encourage healthy snacks at meetings, you can work toward the SCOUT-Strong Healthy Unit Award as a den! Earn the award by following three healthy meeting practices, including providing fruits and/or vegetables for snacks (if snacks are served). Learn more about this award in the Appendix, under “Awards Cub Scouts Can Earn.”

One best practice to facilitate communication and involvement is to distribute a family information letter at the conclusion of each meeting. The letter tells families what was completed at each meeting and provides information on upcoming den and pack meetings and activities. Sample family information letters can be found at [www.scouting.org/CubScouts/Leaders/DenLeaderResources.aspx](http://www.scouting.org/CubScouts/Leaders/DenLeaderResources.aspx).

## DEN OUTINGS

Den outings are an important part of the Cub Scout experience. They are a time not only for fun but for learning. And they are critical steps in your boys’ earning their badge of rank. It is important that you plan in advance for these field trips. Planning should include the following, at a minimum, for each field trip:

- Arrange for the visit with the point of contact at your destination (if needed).
- Work with the parents or guardians in the den to arrange transportation, or get an adult to carry out the planning.
- Fill out a tour and activity plan (No. 680-014), found online at [www.scouting.org/HealthandSafety/TourPlanFAQ.aspx](http://www.scouting.org/HealthandSafety/TourPlanFAQ.aspx). You can also find online help as well at [Scouting.org](http://Scouting.org) on how to fill it out. This plan is a tool for best practices so you will be prepared for safe and fun adventures. Completing the plan may not address all possible challenges, but it can help ensure that you have conducted appropriate planning, that qualified and trained leadership is in place, and that the right equipment is available for the adventure. The plan also helps to organize safe and appropriate transportation to and from an event, and it defines driver qualifications and minimum limits of insurance coverage for drivers and vehicles used to transport participants. This plan should be submitted 21 days in advance (check with your local council to confirm submission date) to ensure your council has enough time to review the plan and assist as necessary.

- It is **MANDATORY** to fill out a tour and activity plan for:
  - Trips of 500 miles or more; or
  - Trips outside of council borders (exception: not to your council-owned property); or
  - Trips to Florida Sea Base, Northern Tier, Philmont Scout Ranch, Summit Bechtel Reserve (***you will be asked to present a copy of your tour and activity plan upon arrival***), national Scout jamboree, National Order of the Arrow Conference, or a regionally sponsored event; or
  - When conducting any of the following activities outside of council or district events:
    - Aquatics activities (swimming, boating, floating, scuba, etc.)
    - Climbing and rappelling
    - At a council's request (***Contact your local council for additional guidelines or regulations concerning tour and activity plans; many have set guidelines for events or activities within council boundaries, such as for Cub Scout overnight camping.***)

When in doubt, check with your local council for their guidelines and regulations for tour and activity plans. Your Cubmaster or pack trainer may be able to provide you with this information as well.

There is an **activity consent** form available to use as well at the den level for outings. This is a permission slip the parents sign for their son to attend the outing. The activity consent form is also available at [www.scouting.org/HealthandSafety/TourPlanFAQ.aspx](http://www.scouting.org/HealthandSafety/TourPlanFAQ.aspx). **Each Tiger's adult partner should be with him at all meetings, including outings!**

It's a good idea at your first den meeting to distribute the Family Talent Survey Sheet to the parents, asking them to complete it and return it to you at the next meeting. (The Family Talent Survey Sheet can be found at [www.scouting.org/CubScouts/Leaders/Forms.aspx](http://www.scouting.org/CubScouts/Leaders/Forms.aspx) or in the Appendix of this guide.) The survey serves as a useful tool for you to identify family resources within your den.

## WORKING WITH CUB SCOUT-AGE BOYS

If you are a parent, you probably have learned a lot about working with boys. If you have more than one child, you probably learned quickly that, while they are different from one another, they do have some common attributes. Knowing and understanding boys is one of the most important skills you bring to your service as a den leader.

**Boys of this age are full of energy.** Den meetings should focus more on doing things and less on talking. Most of the activities designed in the Cub Scout adventures are designed to do exactly this. Physical activities, such as hiking, sports, playing active games, and bike riding, are important. Be sure to make time for physical activity during every meeting. Doing so will not only help boys burn off energy and have greater focus, but it will help them develop this healthy habit. Even talking activities can take place while walking from place to place, allowing boys to be active and burn off some of their energy.

**Youth develop strength, balance, and coordination at this point in their development.** Because these changes take place rapidly, they may appear clumsy, uncoordinated, and awkward. Ensuring that boys have support to try new things is important, but so is focusing on the success they achieve more than awkwardness or failure. Boys of this age will typically enjoy a variety of activities, ranging from craft projects to active involvement in physical activities. Be sure to use the entire den meeting plan as designed, as it is intended to reach the varied interests of youth during the time that the den meets together.

**During this phase of childhood, children are concerned with developing a social circle,** particularly of the same gender. A Cub Scout den serves this purpose very well. Work to ensure that all boys are welcome within the den. Boys begin to feel loyalty to clubs and groups, and the peer group that Cub Scouting can provide is an ideal place to develop this sort of affiliation. Cub Scout-age boys also begin to look up to older youth and will begin to imitate their behavior. For this reason, if you can recruit a den chief as an older role model, you will be serving the boys in your den especially well.

**Boys of Cub Scout age look for role models.** It is important that you set a strong positive example for the boys in your den. Boys of this age are sensitive to adult feedback and interactions. They are also seeking your approval, so keep in mind that anything you say or do will make a lasting impression on them. You can do this well by preparing for den meetings and ensuring that all boys have a complete and fun program to take part in. Planning and implementing a well-organized den meeting will also keep the boys focused on positive activities, which reduces the need to deal with off-task behavior or disciplinary issues within your den.

**Intellectually, children of this age are focused on exploration.** Their interests are likely to change regularly during this time; this is one reason the Cub Scout program provides a rich set of experiences both within the required adventures as well as the elective adventures. The materials in the den meeting plans are designed to deliver the information in small, boy-sized pieces. Don't allow the boys to be overwhelmed by any of the activities in the den. The performance standard in Cub Scouting is to encourage a boy to do his best.

**This phase of childhood is when abstract reasoning and thinking skills are developing.** Many of the outcomes of Scouting are abstract in nature: values and ideals in particular. We seek to support this growth by providing activities that will help to grow these positive values week by week and month by month in den meetings, pack meetings, and outdoor adventures.

**Boys of this age are ready to try new things, and are easily motivated to do so.** Use the den meeting materials to encourage your boys to try new things. Many of the elective adventures offer rich areas for personal development. Encourage boys in your den to explore with their families adventures that your den may not visit during den meetings.

**School can be a frustration for boys of this age.** Cub Scouting can be a safe haven for them as they have a chance to try experiences that are not part of the school experience, as well as try traditional academic tasks in a setting that is hands-on and exploratory. Cub Scouting activities also support what takes place in school by providing an informal education setting designed to help boys learn and thrive.

Because of the pace of change and challenges, **self-confidence can be undermined as boys move through this age range.** During this phase, boys often compare themselves to their peers. If they believe that they are not as talented as their peers, their self-confidence can be undermined. Help the boys in your den see the good in what they do by offering sincere praise and recognition for the work that they accomplish. For this reason, be sure that the recognition devices they earn are presented to them as quickly as possible; the adventure loops and pins are referred to as immediate recognition devices for this reason. Remember to focus on boosting your Scouts' self-confidence through praise and recognition for the good work they do. When giving praise, be sure to note the effort that boys in your den deliver, focusing on the Cub Scout standard of doing their best.

Do not make comparisons to others. If a boy makes a comparison, help him understand that we are all different and changes are unique for each boy.

**The emotional development of boys at this point is closely related to how they get along with other children.** Scouting gives a place for positive social interactions with others and builds a foundation for positive social interactions that will carry on into adolescence and to adulthood. What you do as a den leader makes a difference in the lives of boys.

See Appendix 2 for additional information and specific ideas for working with Cub Scouts, creating den spirit, and tracking behavior.



## ◆ PROVIDING ENCOURAGEMENT

- Reward more than you criticize, in order to build self-esteem.
- Praise immediately any and all good behavior and performance.
- Change rewards if they are not effective in motivating behavioral improvement when needed.
- Find ways to encourage a Scout who is struggling.
- Teach the Scout to reward himself. This encourages him to think positively about himself.



## ◆ PROVIDING SUPERVISION AND DISCIPLINE

- As a leader, you must be a number of things to each boy: friend, authority figure, reviewer, disciplinarian, resource, and teacher.
- Listening is an important technique that means giving the Scout an opportunity to express himself. Whether as a part of the group or in private conversation, be patient, be understanding, and take seriously what the Scout has to say. Keep yourself attuned to what he is saying; use phrases like, “You really feel that way?” or “If I understand you right. . . .”
- Avoid ridicule and criticism. Remember, all children have difficulty staying in control.
- Remain calm, state the infraction of the rule, and avoid debating or arguing with the Scout.
- Have pre-established consequences for misbehavior for all Scouts.
- When a Scout is behaving in an unacceptable manner, try the “time out” strategy or redirect his behavior.
- Administer consequences immediately, and monitor proper behavior frequently.
- Make sure the discipline fits the offense and is not unduly harsh.
- Enforce den rules consistently.
- Do not reward inappropriate behavior. Praise when a Scout exerts real effort, even if unsuccessful, and/or when he shows improvement over a previous performance. Never praise falsely.
- Do not accept blaming others as an excuse for poor performance. Make it clear that you expect each Scout to answer for his own behavior. Behavior is a form of communication. Look for what the behavior is saying (i.e., does the Scout want attention?).

## WORKING WITH CUB SCOUTS WITH SPECIAL NEEDS AND DISABILITIES

We are all aware that every boy is different and unique in his own way. All boys have different ways they learn and different abilities. When we read or hear the term “disability” we more commonly think of visible forms of disability and not necessarily those that are not visible. It’s obvious that a Scout in a wheelchair may have challenges fulfilling a hiking requirement, but it might not be so obvious when it comes to identifying the challenges faced by a Scout with a learning disability.

Since its founding in 1910, the Boy Scouts of America has had fully participating members with physical, cognitive, and emotional disabilities. The basic premise of Scouting for youth with disabilities is that every boy wants to participate fully and be treated and respected like every other member of the Cub Scout pack. Young men or boys with cognitive, physical, or emotional disabilities should be encouraged to participate in Scouting to the extent their abilities will allow. Many Scouts with disabilities can accomplish the basic skills of Scouting but may require extra time to learn them. Working with these youth will require patience and understanding.

Begin with the Cub Scout and his parents or guardians; seek guidance from them on how best to work with the Scout with special needs. The parents or guardians can help you to understand the Scout’s medical history as well as his capabilities, his strengths and weaknesses, and ways they can support

you as his den leader. This will help you become aware of special needs that might arise at meetings, field trips, and campouts with his parents. To the fullest extent possible, Scouts with disabilities should be given opportunities to camp, hike, and take part in all activities.

The best guide to working with Scouts who have disabilities is to use good common sense, to trust your instincts, and to focus on all the potential that Cub Scouts with disabilities do have. It's important to try to remember that Cub Scouts are first and foremost boys, whether they have a disability or not.

Below are some helpful tips for working with Scouts with special needs and disabilities:

### ◆ LEADERSHIP TECHNIQUES

- Wise leaders expect challenges but do not consider them overwhelming. All boys have different needs. The wise leader will recognize this and be prepared to help.
- Leaders should make a personal visit to the parents and the new Scout with a disability to learn about the Scout, any physical or cognitive limitations, his abilities and preferences, and whether he knows any of the other boys in the pack. Some young people with disabilities will try to do more than they are capable of doing, just to “fit in” with others, which could result in unnecessary frustration.
- Many youths with disabilities have special physical or health needs. Parents, visiting nurses, special education teachers, physical therapists, doctors, and other agencies can help make you more familiar with the nature of the disability. Get parent permission before contacting health care persons.
- Accept the Scout as a person, and give him the same respect that you expect from him. This will be much easier to do if you know the Scout, his parents, his background, and his likes and dislikes. Remember, any behavior that presents difficulties is a force that can be redirected into more acceptable pathways.
- With some boys with special needs, a “buddy system” can be very effective. If it is appropriate for the new Cub Scout, explain the system to the den. Each week, a different den member will be responsible for helping the new Cub Scout during the meeting. Emphasize that the important factor is to “Do Your Best” and that the boy who is helping must be patient—not only because of the special needs of the Cub Scout but because the new boy is new to Cub Scouting. Practice the planned activities, with each boy taking a turn at helping and being helped. Often, boys learn more about helping others when they themselves are helped.
- Example is a wonderful tool. Demonstrate personal discipline with respect, punctuality, accuracy, conscientiousness, dignity, and dependability.
- Become involved with the Scout in your care. Let him know that you care for him. A small word of praise or a pat on the back for a job well done can mean a lot to a boy who receives little elsewhere. Judge accomplishment by what the Scout can do, not by what someone says he must do or by what you think he cannot do.
- Rewarding achievement will likely cause that behavior to be repeated. Focus rewards on proper behavior and achievement.
- Do not let the Scout or parents use the disability as an excuse for not trying. Expect the Scout to give his best effort.

### ◆ GIVING INSTRUCTION TO YOUTH WITH DISABILITIES

- Maintain eye contact during verbal instruction, except when the Scout's culture finds this inappropriate.
- Make directions clear and concise. Be consistent with instructions.
- Simplify complex directions. Give one or two steps at a time.
- Make sure the Scout comprehends the instructions before beginning the task.
- Repeat instructions in a calm, positive manner, if needed.
- Help the Scout feel comfortable with seeking assistance.

## ◆ **ADVANCEMENT GUIDELINES FOR CUB SCOUTS WITH SPECIAL NEEDS OR DISABILITIES**

The current edition of the *Guide to Advancement* is the official source for administering advancement in all Boy Scouts of America programs. Section 10 deals with advancement for members with special needs. Topic 10.2.1.0 addresses issues specific to Cub Scouting:

Cub Scouts with disabilities may have difficulty completing the requirements to advance. However, it is important that these Scouts feel as much like others as possible. Therefore, completing the requirements as stated in his youth handbook should be a primary objective. And, as with all Cub Scout advancement, the Cub Scout motto “Do Your Best” should be the standard for performance.  
GTA 10.2.1.0

There could be times, however, when a Cub Scout’s “best” isn’t enough even to get a start. For example, a boy in a wheelchair cannot pass requirements calling for walking or running. In these cases, the Cubmaster and pack committee may jointly determine appropriate substitutions that are consistent with the Cub Scout showing he can “do his best.”

For additional information on working with Cub Scouts with special needs, see the appropriate chapter in the *Cub Scout Leader Book*. In the Appendix of this guide, you will find definitions of disabilities and guidelines for specific types of special needs and disabilities.

## **HELPFUL HINTS FOR DEN LEADERS**

Prepare yourself to “Do Your Best” as a den leader by focusing on the leader materials and training you should have to best serve your Cub Scouts.

The following are some hints that will help you better plan and execute your den meetings.

## **PLANNING YOUR MEETINGS IN ADVANCE**

Plan your meetings ahead of time with emphasis on the flow of activities. Pay special attention to the “Notes to Den Leader” section at the start of the adventure as well as the “After the Meeting” sections of den meeting plans for preparation and materials needed for the next meeting. You will want to alternate between quiet and more vigorous activities; the den meeting plans are designed with this approach in mind. Boys have a lot of energy to expend, so be sure you have an active game or other activity to help channel some of that energy. In addition to the Gathering activity, there are additional games in the Appendix to this guide that will help you keep the boys on track and having fun. Dens that incorporate regular physical activity and other healthy practices into their meetings can earn the SCOUTStrong Healthy Unit Award. Encourage your Scouts to participate in physical activity at the den meeting and help them earn this award (more information can be found in the Appendix). Plan on investing 45–60 minutes to read through the den meeting plans and prepare for the den meeting. The time invested in planning and preparing will ensure that your meeting runs well and is fun for the Scouts.

## DEN RULES AND CODE OF CONDUCT

At the beginning of the year, establish the rules that the den will follow and the consequences for breaking those rules. Boys should participate in the decision-making process. By helping decide what can and can't happen in the den, boys will feel a sense of responsibility toward how the den is run. They will feel that the den is "theirs." Have them design and then sign a poster on which the code of conduct is written and display it at your meeting place. Or make two copies: one that boys can keep at home and one to be displayed at the den meeting after both the boy and his parent have signed it.

## DUTY TO GOD ADVENTURES

The BSA maintains that no member can grow into the best kind of citizen without recognizing an obligation to God; the BSA supports all faiths and faith practices equally, whether the youth and his family are members of an organized religious body or not. All Scouts show this by being faithful in their duty to God as their family practices their faith and by understanding the 12th point of the Scout Law: "Reverent."

The duty to God adventures in the Cub Scout rank requirements encourage a Cub Scout to work with his family to thank God and to develop an awareness of his own personal beliefs in relation to his duty to God. These adventures are primarily home-based adventures. As the den leader, you should let parents know they need to help their Cub Scout complete the duty to God adventure. If your pack is sponsored by a religious body or all members of your den share the same faith, you may choose to incorporate the duty to God adventures into your annual den meeting plans, working with the families in the den to achieve these adventures.

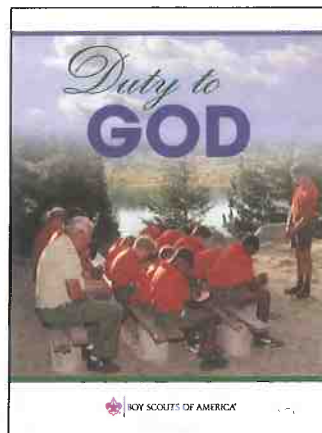

The religious emblems program is mentioned in each rank's duty to God adventures. The emblem for a faith can be earned by the Scout by completing the specific program requirements. You may also want to check with your Cubmaster or the pack committee chair for the program materials if you are chartered by a faith-based organization.

Additional information for taking part in the religious emblems program is available at [www.scouting.org/Awards/ReligiousAwards.aspx](http://www.scouting.org/Awards/ReligiousAwards.aspx) or [www.praypub.org](http://www.praypub.org); your religious education leaders may also have information on these recognitions.

## CEREMONIES

Ceremonies are important for marking the beginning and end of each meeting. They are also a time for reinforcing the aims and purposes of Scouting, marking important events, and bringing the boys together. As boys finish achievements toward their badges, simple ceremonies during the den meeting will serve to congratulate them on their accomplishments. You will find suggested ceremonies in the Appendix of this guide or in the resource *Ceremonies for Dens and Packs* (BSA No. 33212) available at your local Scout shop. Some packs maintain a library of resources; check with your Cubmaster to see if these materials are available within your pack.

Den ceremonies should be short—no longer than two or three minutes—and varied. The same opening and closing each week will become boring. Occasionally, the boys should have a chance to help plan and lead den ceremonies. Here are some types of den ceremonies to consider using in your den meetings:

- An opening ceremony, often a flag ceremony, signals the beginning of the den meeting.
- A progress toward ranks ceremony can acknowledge a boy's progress toward his rank advancement.
- A denner installation ceremony recognizes a boy leader and the importance of this position in Cub Scout and Webelos dens.
- Special recognition ceremonies can mark special events such as birthdays and holidays.
- Closing ceremonies can emphasize Cub Scouting's ideals and bring a quiet, inspirational end to the den meeting.

## IMMEDIATE RECOGNITION

A den doodle is an object for the boys to use to show off their accomplishments and achievements. In the Appendix of this guide there are ideas for den doodles. Your den of boys can design and create their own den doodle as a den meeting activity at the start of the year. Use the den doodle to keep a visual reminder of activities the den has completed and shared.

Adventure loops can also be awarded at the den level or at the pack level. Awarding an adventure loop at the pack level lets all the pack know of the Scout's achievement during an advancement ceremony! Check with your Cubmaster and pack leadership for the practices your pack follows. No Cub Scout should be required to wait more than two weeks to receive an award.

## MISSED MEETINGS

Circumstances occur when a boy may miss one or more of the den meetings you've planned. Transportation issues, illness, or sports and school activities may require the Scout to miss meetings. **DO YOUR BEST** to communicate the requirement(s) or activities that were missed to his parents or guardian. Determine if you have program materials you can share, such as activity items or notes on the outing, that a family can use to help the boy achieve what was missed. Sharing the content of this book can be a great help as well. It is not the expectation that you alone need to help him make up the missed work. It is a combined effort between you as his leader, the boy, and the boy's family. The Cubmaster is a good resource as well for you to consult with if a boy is consistently missing meetings.

## SNACKS/TREATS

Healthy snacks and water at meetings help set an example of healthy eating habits. If a snack is served during meetings, have fruits or vegetables and save the treats for a special occasion. Offering fruits or vegetables can also help you avoid concerns with common food allergies; however, it's best to discuss allergies with families before the first meeting. You can motivate Cub Scouts to try healthy foods by working toward the SCOUTStrong Healthy Unit Award as a den, which requires fruits and/or vegetables as snacks during meetings. Learn tips to get started and more about this award in the Appendix under "Awards Cub Scouts Can Earn."



## DEN SCRAPBOOK

A great idea for each of the boys in your den is to create a scrapbook early in the program year. Fill the scrapbooks with sample artwork that the boys create as den activities, stories about their adventures, and pictures taken of boys with their completed projects. The den scrapbooks will be treasured mementos proudly displayed at the boys' Eagle Scout court of honor in just a few years!

## TRACKING THE ADVENTURE

It is important to keep track of what has been accomplished by the Scouts as they advance through the adventures and meet the requirements for each rank. Families will keep track of adventure requirements completed at home in each Scout's handbook. Coach parents in the value of recording accomplishments regularly in their son's handbook. A parent's or adult partner's signature will document completion of home-based requirements.

For ease in keeping track of advancement requirements, advancement posters are available at your local council Scout shop (Tiger, No. 34715; Wolf, No. 34182; Bear, No. 34191; Webelos, No. 34187). On a regular basis, transfer requirements completed at home to a tracking sheet or electronic record. Keeping track of completed requirements in a single place will also help you share accomplishments with your pack's advancement coordinator, who will order awards each month. The awards will be presented monthly at the pack meeting.

## SUCCESS

Leadership is learned and developed. You can become an effective den leader if you complete basic training, plan interesting den meetings, and take the time to understand the boys. Become familiar with the Cub Scout handbook, and provide opportunities for advancement. One of your best resources is your district's monthly Cub Scout leader roundtable, where you can exchange ideas with other den leaders. Remember to be flexible in your planning. Have fun in the program. Be thankful for the opportunity you have to work with boys and influence their lives. There is great satisfaction in helping boys learn good values and worthy skills along their way to becoming adults.



# Required Adventures

C

... ..

C

C





# BACKYARD JUNGLE



## RATIONALE FOR ADVENTURE

In this adventure, Tigers will learn that there are many types of living things that share the place where we live. All animals, plants, and insects have a purpose in our environment. It is everyone's duty to be mindful of other creatures' habitats. Regardless of their age, Tigers can make a difference.

## TAKEAWAYS FOR CUB SCOUTS

- Learning about the creatures and plants that share our living world
- Knowing it's never too early to understand our animal and insect neighbors
- Learning how to protect the environment
- Practicing service to the community and the world
- A Scout is thrifty, kind, clean. 

*Tiger Handbook, page 30*

## ADVENTURE REQUIREMENTS

1. Take a 1-foot hike. Make a list of the living things you find on your 1-foot hike.
2. Point out two different kinds of birds that live in your area.
3. Be helpful to plants and animals by planting a tree or other plant in your neighborhood.
4. Build and hang a birdhouse.
5. With your adult partner, go on a walk, and pick out two sounds you hear in your "jungle."

## NOTES TO DEN LEADER

This adventure is family-based, but it can be adapted easily to the den setting. Significant advance notice may be necessary to secure donations of trees or seedlings.

In addition, you may need to prepare for the tree planting in Meeting 3 as an outing. In advance of the outing, the leader will need to make arrangements with the outing location and confirm the outing plan with families, including transportation and any additional items they need to bring. Make sure a tour and activity plan has been submitted, if required, and activity consent forms are distributed, signed, and collected.

See the Appendix for optional den meeting activities, including openings, gatherings, and closings.

## MEETING 1 PLAN

### PREPARATION AND MATERIALS NEEDED

- U.S. and den flags
- Poster of the Scout Oath and Scout Law
- Index cards with each principle of the Outdoor Code
- Materials for building a birdhouse (See Activity 1.)
- 1 large towel, such as a beach towel, for each Scout and partner team
- 1 inflated beach ball for each team
- A talking stick (See Closing.)
- Read the Backyard Jungle adventure in the *Tiger Handbook*.

## GATHERING

Play the Beach Ball Toss game. Divide the players into two-member teams, and give each team a towel and a ball. They hold the two ends of their towel so it spreads wide between them. Then, without touching the ball, they use the towel to toss it to other teams. As the game progresses, to make it more challenging, put four players on one towel or have the teams toss the ball over a net or rope stretched across the room.

## OPENING

- Conduct a flag ceremony of your choosing that includes the Pledge of Allegiance and, as appropriate, the Scout Oath and Scout Law.
- Using a poster showing the 12 points of the Scout Law, have Tigers recite the Scout Law together with you. (A hand-lettered poster will suffice if a printed one is not available.) Have the Tigers identify which points of the Scout Law apply to protecting the environment. Then ask them why they chose those points.

## TALK TIME

- Carry out business items for the den.
- Introduce the Backyard Jungle adventure to the den. Build interest by describing the goals of the adventure and some of the activities that are planned.
- Introduce the Outdoor Code, which appears in the back of each Scout's handbook. As Tigers, the focus will be on one principle: "Be clean in my outdoor manners."

Have the Tigers pair up. Give each pair a card with one of the principles of the Outdoor Code, and ask them to talk about their principle and how it might be explained or demonstrated to everyone. After a minute or two, each Tiger pair should give a brief summary. Tell the Tigers that they will explore their living world during this adventure and will need to think about ways to take care of it.

## ACTIVITIES

### ◆ Activity 1: Make and Hang a Birdhouse (Requirements 2 and 4)

#### Step 1: Build a Birdhouse (Requirement 4)

- **Milk or Juice Carton Bird Feeder.** This is one option for making a birdhouse. Have each Tiger and his adult partner cut the sides out of a rinsed-out, cardboard milk or juice container while leaving the corners in place. If time permits, paint and decorate the carton. Punch a hole in the top large enough for a piece of yarn or ribbon to pass through, and form a loop large enough to go around a tree branch. Poke small holes in the bottom. Fill the bottom of the carton with bird seed, if you choose.



### Step 2: Hang the Birdhouses (Requirement 4)

- Once each Tiger and adult partner pair has made a feeder, discuss with your den where to hang the feeders to attract the most birds. Also discuss how you may observe birds feeding without disturbing them.

### Step 3: Bird Walk (Requirement 2)

Go outside, and choose a safe path where Tigers are likely to spot birds. Walk the path quietly, and watch for birds as you walk. When you spot a bird, ask the Tigers and their partners to answer the following questions in their jungle notebooks:

- What color is the bird?
- How big is it?
- Can you see the bird's home? What kind of home does this bird live in?

Share that many birds' homes are called nests. Birds make their own nests to help keep them warm and to hold their babies or eggs when they are away from the nest. Ask: What are their nests made of? Do you see any babies in the nest? What sounds do they make?

Guide Tigers and their partners to resources such as a library or the Internet to learn about birds that migrate through their area. If your area is home to several species of birds, be sure to include them in the conversation.

### ◆ Activity 2: Outdoor Sounds (Requirement 5)

This activity can be held after the bird watching, with the bird feeders hanging in trees. Allow the den members to continue their walk, following the directions below.

1. Go outside for a short walk. Explain to the Tigers that when you are outside, you should not talk, just listen. In a safe place, have them stop and close their eyes. Ask them, "How does closing your eyes make it easier to hear the sounds?"
2. See how many non-human sounds they can identify. Ask if they can hear any animal noises. Can they identify which animal is making the sound?
3. Have the Tigers record what they observed either by writing or drawing pictures in their jungle notebooks to illustrate it. If a nest is spotted, have them identify the type of material the birds used to build the nest, making sure not to disturb it.

#### NOTE TO DEN LEADER

For a different experience, try going outside at different times of the day to hear different sounds. Ask the Scout, "What sounds do you hear in the early morning or late at night?"

### CLOSING

- If Tigers are not familiar with a talking stick, introduce the concept here. Gather the Tigers into a circle. Explain that only the person holding the "talking stick" or "object from nature" will be able to speak. The rest of the den listens as each Tiger and his partner share one favorite thing about the bird walk.

### AFTER THE MEETING

- Share a snack and drink, if appropriate.
- Make sure all participate in cleaning up from the craft and the snack, as necessary.
- Record completion of requirements 2, 4, and 5.

# MEETING 2 PLAN

## PREPARATION AND MATERIALS NEEDED

- U.S. and den flags
- Tokens such as beans, play money, playing chips (enough for each Tiger to have 5)
- 1-foot hike materials: string, sticks, paper, pen/pencil
- Sunscreen (at least SPF 30) and a hat to demonstrate sun protection
- Themed hike materials; options include:
  - Egg Carton Hike. Empty egg cartons—cut in half, one half carton per Tiger—with a note inside telling him to collect six objects that fit these six categories: smooth, rough, hard, soft, colorful, and his favorite color.
  - Babies Hike, Circle Hike, or Friend of Nature Hike. Each of these requires paper and a pen/pencil. The Friend of Nature Hike also requires trash bags and nonlatex disposable gloves.
- Plaster of paris and plastic spoons (optional, for Activity 4).

## GATHERING

Play “Odd or Even.” Each player and his adult partner starts the game with five tokens (beans, play money, playing chips). He secretly puts any number of tokens, from 0 to 5, in a closed fist. Then he approaches another player and asks the player to guess “odd or even.” If the player guesses right, he wins a token. If he guesses wrong, he forfeits a token to the questioner. Play continues until time is called. The player with the most tokens when time is called is the winner.

## OPENING

- Conduct a flag ceremony of your choosing that includes the Pledge of Allegiance and, as appropriate, the Scout Oath and Scout Law.
- If the moon is visible, hold the opening outside, and salute facing the moon. This is acceptable because an astronaut placed a flag on the moon.

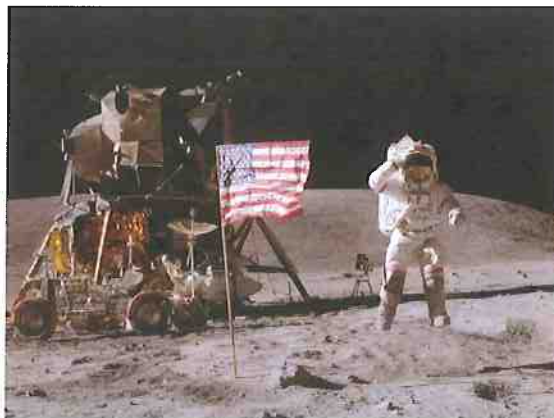

## TALK TIME

- Carry out business items for the den.
- Explain to the Tigers the type of hike they will be taking. (Options are described in Activity 1.)
- Remind them before they go outside that they need to protect their skin from the sun with sunscreen. Ask them how they can be prepared for rain or other weather when they are outside.

## ACTIVITIES

### ◆ Activity 1: Hike (Requirement 1)

1. Take a 1-foot hike.
2. If time permits, choose an additional hike from the following options:

#### 1-Foot Hike (Requirement 1)

Help Tigers stake out a 1-foot-by-1-foot square outside, near the meeting place. Encourage them to write down or draw pictures of every living thing that they see in this small space. Ten minutes is sufficient for this activity. After the Scouts have recorded their observations, give them time to describe what they observed to other members of the den. If appropriate, invite them to talk about how this activity would be different if carried out in a different place and what they might expect to see elsewhere.

## Options for Themed Hikes

- **Egg Carton Hike.** Each Tiger receives one half of an empty egg carton. During the hike, Tigers collect objects from nature to put in their containers. Adult partners help each Tiger find one example of each of the following: something smooth, something rough, something hard, something soft, something colorful, and something that is his favorite color. During this hike, Tigers may ONLY put in their cartons objects from nature that they find on the ground. Remind them that whatever they collect to share with the group will be returned to nature after the meeting. Doing so is one way Tigers will learn to follow the principles of Leave No Trace.

### NOTE TO DEN LEADER

If a Tiger sees something that fits one of the categories, but he cannot take it because it is alive or not on the ground, he may record what he observed on a piece of paper to put in his container.

- **Babies Hike.** Each Tiger/adult partner team searches an assigned area for babies of all kinds—plants, animals, and insects. Remind them to only observe and never disturb. They should be ready to share with the group about the things they found.
- **Circle Hike.** All participants form a circle in the selected observation area, and identify as many different living things as possible within the circle. This can also include evidence of living things, though you may not see the creature itself. For example, you may see a spider web but not see the spider. The circle can be made larger by taking steps backward if the observation area needs to expand.
- **Friend of Nature Hike.** Provide each member of the den with a trash bag and nonlatex disposable gloves. During the hike, each Tiger commits to being a “friend of nature” by putting in his bag anything that does not naturally belong in the area.

### ◆ Activity 2: Reflection

1. Gather the Tigers and partners outdoors (if weather and time permit) to share their collections/observations.
2. Ask about the animals, insects, and birds they observed. The goal is to identify at least two different kinds of birds and at least five different animals and insects in our living space.
3. Collect the observations they have written or drawn for display at the next pack meeting (optional).

### ◆ Activity 3: Skit Preparation (Optional)

In preparation for the pack meeting, practice a skit based on the theme for the month, such as the one listed below.

#### The Lost Tigers Skit

**Narrator:** Our Tiger den has been busy learning about our environment and how to help take care of it. They recently participated in a hike, walking through some dangerous territory—the backyard! They learned how to navigate safely out of this precarious spot. Things got pretty scary when they lost their way, but our brave Scouts employed their newly learned tracking skills. In fact, if we listen carefully, we should be able to hear how they found their way out.

**All Tigers (together, yell):** “Mr. (or Mrs.) Cubmaster!”

### ◆ Activity 4: Starting Spoon Beetles (Optional)

1. To prepare for the “spoon beetle” activity for the next den meeting, it is an option to create the plaster of paris molds in advance—which will allow extra time for them to dry.
2. Mix together some plaster of paris and pour the mix into plastic spoon molds for the next week’s “spoon beetles” activity. (See Meeting 3 Gathering for detailed instructions.)
3. Set aside to dry, and bring the molds to the next meeting.

## CLOSING

Form a living circle, and give the grand howl. To form a living circle, have the Tigers make a circle, standing with their left shoulders facing inside the circle. Then have them extend their left arms into the center of the circle, making a fist with their thumbs out. Each Tiger will grab the thumb next to his fist until everyone is joined by holding thumbs. The den leader or designated Tiger begins the yell with "ARRR..." (the grand howl). Then, with their right arms straight up making the Cub Scout sign, they will yell, "AKELA, we'll do our best!" (See page A-22 in the Appendix.)

## AFTER THE MEETING

- Share refreshments if appropriate.
- Record completion of requirement 1.
- Collect recorded observations if they are being saved for the pack meeting. Encourage Tigers to return the items in their egg carton collections to nature.
- Clean up the plaster of paris materials.
- Complete preparation for tree planting (requirement 3).

# MEETING 3 PLAN (Den Outing)

## PREPARATION AND MATERIALS NEEDED

- U.S. and den flags
- The Outdoor Code (See the *Tiger Handbook*.)
- Preparation for tree planting (See Meeting 3 Resources.)
- "Which Animal Am I?" game; requires tape, slips of paper with names of animals
- Spoon beetle materials (See Gathering below.)
- Unit den leader should have in possession (if required by local council practices) the tour and activity plan, signed activity consent forms, and a copy of the *Guide to Safe Scouting*.

## GATHERING

Have Tigers make and decorate spoon beetles. Use the plaster molds created in the spoons at the previous meeting. Using paint, glitter, sequins, stickers, markers, felt pieces, etc., let Tigers decorate their molds to look like beetles. Help them glue magnets to the flat sides of the molds, and set the beetles aside to dry.

### NOTE TO DEN LEADER

The best results are obtained when the plaster has dried for at least 24 hours. The plaster molds may be made ahead by the leader or at the end of the previous meeting.

### Materials:

- Plaster of paris (available at most craft and hardware stores)
- 1 box of plastic spoons
- Plastic bowl
- Paints (Acrylic will work best.)
- Paintbrush (Cotton swabs are an inexpensive alternative.)
- Small refrigerator magnets (Optional; if used, press lightly into the plaster of paris as it hardens on the bowl of each spoon.)

### Instructions:

1. Mix the plaster of paris according to the instructions on the box.
2. Pour the plaster of paris into the bowl of each spoon, and let it harden (preferably overnight).
3. Once it is dry, you should be able slide the plaster of paris right off the spoon. The molds are then ready to paint.
4. Have the Scouts decorate their beetles.



### OPENING

- Say the Pledge of Allegiance and, as appropriate, the Scout Oath and Scout Law. If the den does not have a United States flag on the outing, ask one Scout to display the flag on his uniform for the group.

### TALK TIME

- Carry out business items for the den.
- Ask how trees help clean the air and improve the environment. Allow time for sharing ideas.
- Share the Outdoor Code. (See the *Tiger Handbook*.)
- Explain to Tigers that this type of code is like a promise. Ask them why they think we need codes. Encourage Tigers to tell what this code means to them.

### ACTIVITIES

#### ◆ Activity 1: Tree Planting (Requirement 3)

**Option 1:** Plant a tree. (See Meeting 3 Resources.)

**Option 2:** Clean and winterize a flower bed for a church, charitable organization, or school.

**Option 3:** Plant a seedling and let it grow indoors until weather permits planting outside.

#### NOTE TO DEN LEADER

If weather, time of year, or plant availability makes planting a tree impossible, choose an alternate activity. Make sure to obtain permission prior to doing any work.

#### ◆ Activity 2: Play the “Which Animal Am I?” Game

1. Make slips of paper with the names of animals on them, such as *ostrich, monkey, rhinoceros, elephant, giraffe, parrot, dolphin, shark, chihuahua, polar bear*.
2. Without revealing the names, tape one slip of paper on each player’s back. Tigers must ask yes-or-no questions until they can guess which animals they are.

#### ◆ Activity 3: “My Big Backyard” Game

Everyone, including adult partners, plays this game. Have everyone stand or sit in a circle. The leader begins the story by saying, “Today in my backyard, I saw \_\_\_\_\_.” He or she then fills in the blank with anything real or imagined. Each person gets a turn and must first repeat what everyone else has said (“I saw a \_\_\_\_\_, a \_\_\_\_\_,” etc.) and then add one more thing until the story has gone all the way around the circle. Tigers may need some help with remembering, so it’s OK to give them prompts.

## CLOSING

All the participants form a circle and hold hands for a prayer. Choose a person who will open and close the prayer. Ask Tigers and their adult partners to share something they are thankful for and then squeeze the hand of the person next to them. If anyone is uncomfortable sharing aloud, they can simply squeeze the next person's hand without saying anything. The same person who began will end the prayer after everyone has had an opportunity to share. One good way to incorporate the adventure's theme is to have each Tiger and partner identify something they are grateful for that is found near where they live.

## AFTER THE MEETING

- Share refreshments, if desired.
- Make sure everyone assists in cleaning up, especially from the spoon beetles activity.
- Record completion of requirement 3.

Upon completion of the Backyard Jungle adventure, your Tigers will have earned the adventure loop shown here. Make sure they are recognized for their completion by presenting the adventure loops, to be worn on their belts, as soon as possible according to your pack's tradition.



## MEETING 3 RESOURCES

### PLANTING A TREE

#### NOTE TO ADULT PARTNER

Be sure you have permission to plant a tree in the planned location.

If you will be planting the tree in a location other than your den's usual meeting place, be sure that information has been confirmed with families.

Some organizations may be willing to donate trees or allow you to purchase them at a reduced rate. These include:

- Local nurseries
- U.S. Forest Service
- The Arbor Day Foundation
- Bureau of Land Management
- County agricultural commissioner's office

In addition, many states have tree-planting programs. Information may be obtained on the Internet, at the local library, from local civic organizations, etc.



## How to Plant Trees

**Materials:** shovels, seedlings, water, soil

The outline below may be helpful in showing the simple steps for planting a tree with Scouts. Trees and shrubs are a very important part of the environment. They provide several things including shade from the sun, shelter from strong winds, and homes and food for birds and other animals. They also produce oxygen for everyone to breathe, and they protect soil from damage by raindrops. Most trees live for a long time!

1. Dig a hole. Make the hole twice as wide and deep as the size of the container the tree came in. You will want to break up the soil from the hole thoroughly with your hands or with a shovel.
2. Carefully remove the plant from its container. First, break off any roots growing out of the container. Next, holding the seedlings between your first and second fingers, turn the tree's container upside down. Gently tap the bottom, and squeeze the container slightly to loosen the soil. Try to ease the plant out of the container without pulling it, and try to keep the soil column surrounding the roots intact. Again, it's a good idea to trim any roots that are long or that may have grown outside the container.
3. Plant your tree seedling. Support the roots and stem while filling in the hole. If you use fine soil to fill in around the roots, you can then pat it down and make it firm with your fingertips.
4. Water your seedling right away with one-half to a full bucket of water. You will need to pour the water gently so the soil isn't washed away.
5. Look after your tree or plant, as it needs weeding and water. If you place mulch around the base of the tree, it will help keep the weeds out. Newspaper, black plastic, gravel, and woodchips all make great mulches.
6. Now watch your tree grow! It may be fun to measure your tree as it grows, and watch what kinds of insects, birds, or other animals are attracted to it. Thank you for helping to improve the environment!

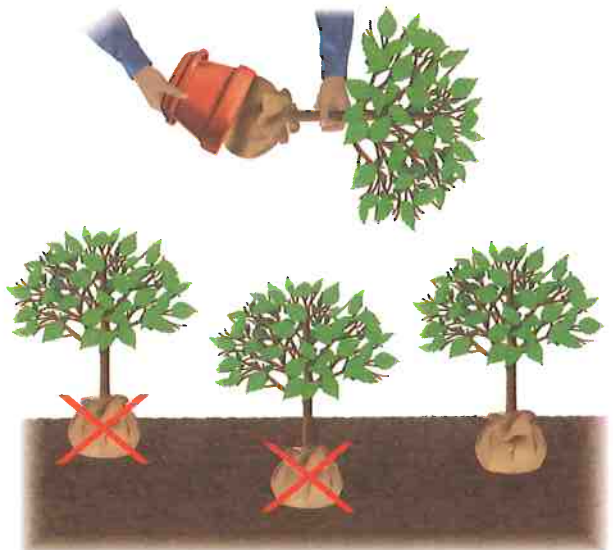
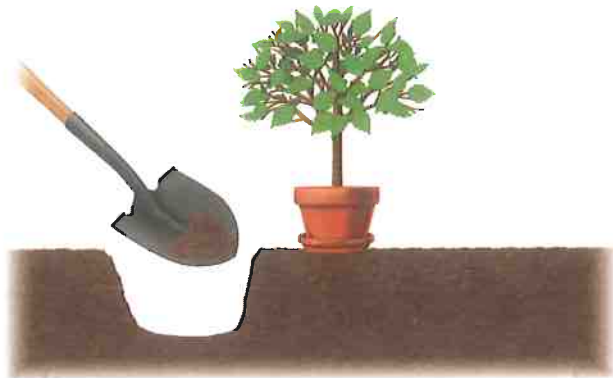

C

C

C



# GAMES TIGERS PLAY



## RATIONALE FOR ADVENTURE

This adventure will help boys develop appropriate emotional responses, engage in shared decision making in group settings, and encourage an active and healthy lifestyle.

## TAKEAWAYS FOR CUB SCOUTS

- Learning how to respond when they win or lose
- Seeing the value of teamwork
- Developing problem-solving skills
- Playing cooperative games
- Learning how to build teams
- Creating new games
- A Scout is friendly, brave. 

*Tiger Handbook, page 42*

## ADVENTURE REQUIREMENTS

1. Do the following:
  - a. Play two initiative or team-building games with the members of your den.
  - b. Listen carefully to your leader while the rules are being explained, and follow directions when playing.
  - c. At the end of the game, talk with the leader about what you learned when you played the game. Tell how you helped the den by playing your part.
2. Make up a game with the members of your den.
3. Make up a new game, and play it with your family or members of your den or pack.
4. While at a sporting event, ask a player or coach why he or she thinks it is important to be active.
5. Bring a nutritious snack to a den meeting. Share why you picked it and what makes it a good snack choice.

### NOTES TO DEN LEADER

Meeting 3 for this adventure is an outing to a sporting event. You will need to identify a sporting event in your community that the Tigers and their adult partners can visit together. The event can range from a middle or high school game to a professional game. Contact the team at least a month ahead to arrange the visit. In addition, arrange to have one of the team's players, someone from the facility, or an expert on the sport meet with the den before the event starts. Provide that person with requirement 4 information for this adventure.

Confirm the outing plan with families, including transportation and any additional items they need to bring. Make sure a tour and activity plan has been submitted, if required, and activity consent forms are distributed, signed, and collected.

There is a home assignment to be completed by the Tiger between Meeting 1 and Meeting 2. For the snack requirement, work with adult partners to decide whether Tigers will bring snacks for themselves or bring extra to share. Adjust plans to accommodate their needs and prevent wasted food.

See the Appendix for optional den meeting activities, including openings, gatherings, and closings.

# MEETING 1 PLAN

## PREPARATION AND MATERIALS NEEDED

- Materials for games (See Meeting 1 Resources.)
- U.S. and den flags
- Copies of the Do-at-Home Project and the informational flier for the Meeting 3 outing
- Read the Games Tigers Play adventure in the *Tiger Handbook*.

## GATHERING

Set up a scavenger hunt around the room or outdoor meeting space in keeping with the Games Tigers Play adventure theme, or give the Tigers a flying disc to keep them engaged while waiting for the others to arrive. (See Appendix for other Gathering ideas.)

## OPENING

- Conduct a flag ceremony of your choosing that includes the Pledge of Allegiance and, as appropriate, the Scout Oath and Scout Law.
- Call roll. Have each Tiger respond with something he might say to encourage someone during a game.

## TALK TIME

- Introduce the Games Tigers Play adventure to the den. Build interest by describing the goals of the adventure and some of the activities that are planned.
- Carry out business items for the den.
- Allow time for sharing among Cub Scouts.

## ACTIVITIES (REQUIREMENTS 1 AND 2)

### ◆ Initiative Game 1 (See Meeting 1 Resources.)

- Choose one of the games listed in the Meeting 1 Resources, and encourage the boys to play that game with their adult partner and the members of the den.
- Introduce the activity as a special kind of game called an “initiative game.” There are no winners or losers in these kinds of games, which help us learn how to work together.
  - If you believe conflict might arise over winning or losing—based on previous experiences with this den—make these comments before the game: Remind the Scouts and their partners that “a Scout is friendly” and knows how to be a good sport. There are no winners or losers in initiative games, but Scouts should still try to stay positive no matter the outcome. Explain to the Scouts that they might feel happy or disappointed, but they can express those feelings appropriately. Tell them it’s OK to be sad or upset because those are feelings we all have, but it’s important not to “act out” just because you are feeling this way.
- After the game, lead a reflection time. (See Appendix for more information about leading a reflection.) Ask the boys:
  - What were their roles in the game, and what were their partners’ roles?
  - Could they have done something differently to change the outcome of the game?
  - How did they feel about the team’s success? Were they able to feel happy or sad and still be a “good sport”?

### ◆ Initiative Game 2 (See Meeting 1 Resources.)

- Invite the Tigers to select and play one of the games listed in the Meeting 1 Resources.
- Encourage them to vote on which game they’ll play.
- Have the den members play the game with each other and their adult partner.
- Lead a reflection time after the game. (See Appendix for guidelines.)

## ◆ “Tigers on the Prowl” Game

- The purpose of this activity is to help Tigers work together democratically in inventing a game they can all play.
- Provide a foam-rubber ball for indoor play or a soccer ball for outdoor play options. Tell the Scouts to make up a game using the ball. Remind them that “a Scout is friendly” to all, and that they should be sure the game they make up is fun and fair for everyone.
  - If they have trouble creating a game, make some suggestions:
    - It should be a game that teams can play—not just a game you play by yourself.
    - How can you use the ball?
    - How do you win?
    - How can you play so everyone wins?
- Have the den members play the game with each other and their adult partner.
- Lead a reflection time after the game. (See Appendix for guidelines.)
  - Use the reflection time as an opportunity to acknowledge feelings of frustration and to celebrate gracious feelings of success. This reflection helps Tigers develop a courteous nature.
- OPTIONAL materials: Carpet squares, hoops, or “caution tape” (to mark a boundary). These items could inspire more ideas and discussion about how to play the game they create.

## CLOSING

- Closing ceremony: Recite the Scout Law (with support from the den leader and adult partner).
- Consider sharing a thought for the day.



### Do-at-Home Project Reminder:

Hand out the home project that needs to be completed before the next den meeting. (See Meeting 1 Resources.)

- Remind each family that their Tiger will need to create a game of his own and play it with his family before the next meeting (requirement 3). He will then play the game with his den at the next meeting.
- Also remind families that each Tiger will need to bring a nutritious snack (requirement 5) to the next den meeting. They will need to share why they chose that snack. Be sure families know of any allergies and foods that should be avoided.

## AFTER THE MEETING

- Confirm the date, location, and transportation plans for the upcoming sporting event.
- Enjoy a healthy snack.
- Work together to clean and tidy up the meeting place.
- Record completion of Tiger requirements 1a, 1b, 1c, and 2.

# MEETING 1 RESOURCES

## INITIATIVE GAMES

### ◆ Ballooney

**Materials:** Balloons

Have everyone in the den form a circle and join hands. The den leader will toss a balloon into the center of the circle. Using only their feet, the Scouts must keep the balloon in the air and cannot let it touch the ground. A different person must kick the balloon each time. To make the game more challenging, the den leader may add more balloons to the center of the circle.

### ◆ Synapse

**Materials:** Timer or stopwatch

Join hands and form a circle. Squeeze the hand of the person next to you, one time. That person then gives the same “signal” to the next person, and it goes around the circle until it reaches the one who started it. The den leader will use a timer to see how fast the signal travels around the circle. Can you do it faster the next time?

### ◆ Blob

Play this game like tag. Mark an area to keep everyone close together. To start, someone must be “it.” When that person tags someone, the two join hands and begin to form a “blob.” Continue until everyone has been tagged and joined hands, and the whole group has formed a blob.

### ◆ Lineup

**Materials:** Bandannas to serve as blindfolds

Blindfold everyone and ask them to remain quiet. They must then form a line according to something specific: birthdate, age, height, first letter of their last names, etc. If two people share the same number, they should stand side by side.

### ◆ All Aboard!

**Materials:** A carpet square or cardboard square to serve as a platform

Everyone in the group must get on the platform. A carpet square, 2 feet x 2 feet, works well for this. To finish the game, all players must have both feet off the ground—at the same time—for five seconds.

### ◆ Monster

The group joins together to “make a monster.” This monster travels using both its “hands” and its “feet,” and makes its own sound before and after it moves. The monster must walk with one more leg and one fewer arm than there are members of the group (so a group of five would form a monster that uses six legs and four arms to walk). When the monster walks, it makes its noise, moves 20 feet or so, stops, and makes its noise again.

### ◆ Hog Calling

**Materials:** Bandannas to serve as blindfolds

Ask each person in the group to pair up with someone they do not know very well. Each pair chooses its own matching set of words. (For example, “salt and pepper” or “black and white” are good choices.) Split the pairs, asking the two members to walk to opposite ends of the room or playing field. When they’re in place, they must put on blindfolds. Then, on a signal, they must try to find each other by shouting their matching words. Leaders will protect players from running into each other or wandering off.



# DO-AT-HOME PROJECT

## GAMES TIGERS PLAY—FAMILY GAME

Get ready to play, Tiger!

1. You and your adult partner should work together to brainstorm a new game to be played at home with your family.
2. Ask your adult partner to help you write the rules for the new game you created and set it up to play.
3. Now invite your family member to come learn and play your game. You and your family can even invite friends from the neighborhood to play it as well!
4. Bring the game you created for your family to your next den meeting, and share it with the other members of your den. You might even have a chance to play it at an upcoming pack meeting.

## GAMES ARE FUN!

### NOTE TO ADULT PARTNER

Here are some simple questions for you to ask your Tiger that can help him reflect and grow from this activity.

- What did you learn from it?
- What did you like about your game?
- What did others like about the game?
- What did you learn when you made the game?
- What did you learn when you played the game with others?

**SNACK TIME!** Tiger, work with your adult partner to bring in a nutritious snack to the next den meeting. Be ready to tell why you chose your healthy snack!



# MEETING 2 PLAN

## PREPARATION AND MATERIALS NEEDED

- Remind Tigers and their adult partners to bring the games they created in the Do-at-Home Project to this den meeting to share with the other den members.
- Remind Tigers they are to bring a nutritious snack and share why they chose it with the other members of their den.
- U.S. and den flags

## GATHERING

### Tiger Shuffle

#### Materials:

- Painter tape or masking tape
- Markers for decorating the caps
- Large plastic bottle caps (juice caps work nicely). The caps should slide easily when shuffled. You will need one cap for each Tiger in the den.

#### Instructions:

1. Use the tape to create a triangle on a table or the floor, and label point levels.
2. Use another piece of tape to mark off at the opposite end of the triangle the starting point to shuffle the cap.
3. As Scouts arrive, let them decorate their caps.
4. Taking turns, each Tiger slides his cap from the starting point toward the triangle and tries to score points while his adult partner cheers for him. Make sure each boy has a chance to play, and let the boys try to better their scores as well.

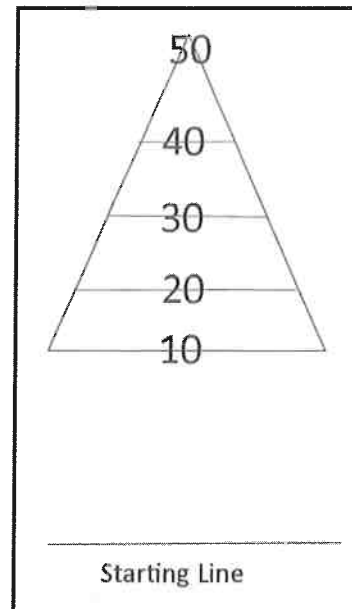

## OPENING

- Conduct a flag ceremony of your choosing that includes the Pledge of Allegiance and, as appropriate, the Scout Oath and Scout Law.

## TALK TIME

- Carry out business items for the den.
- Allow time for sharing among Cub Scouts.

## ACTIVITIES

### ◆ Activity 1: Games Created at Home (Requirement 3)

Have the Tigers one at a time share the games they created at home and played with their family members. Have each Tiger and his adult partner teach their game to the rest of the den members and play it.

### ◆ Activity 2: Snack Share (Requirement 5)

Ask each Tiger to tell about the snack he chose to bring and why it is a good choice. Confirm that no Tigers have allergies to the foods that were brought. Allow time for Tigers and family members to try the different snacks if some Tigers have brought enough to share. Encourage them to try new things and be respectful if they don't care for certain foods.



## **CLOSING**

Here are some simple questions that can help the boys reflect and grow from this activity.

- What did you learn from it?
- What did you like about your game?
- What did others like about the game?
- What did you learn when you made the game?
- What did you learn when you played the game with others?

Hand out an informational flier about the Den Meeting 3 outing to a sports event. (See Meeting 2 Resources for a sample flier.) Make sure all Tigers and their families know the plans:

- Who will attend
- When you are planning to go
- Where you will meet
- Transportation— who will be driving
- What the Tigers should wear or bring
- Rules that the Tigers will need to respect when they participate. Remember, “A Scout is courteous.”

## **AFTER THE MEETING**

- Ensure cleanup takes place.
- Record completion of Tiger requirements 3 and 5.

# MEETING 2 RESOURCES

## GAMES TIGERS PLAY OUTING

Let's get ready!

We will be going to: \_\_\_\_\_

Date: \_\_\_\_\_

Time: \_\_\_\_\_

We will meet at: \_\_\_\_\_

We will get there by: \_\_\_\_\_

Wear and bring: \_\_\_\_\_

A Scout is courteous! Here are some rules we need to follow: \_\_\_\_\_

\_\_\_\_\_

\_\_\_\_\_

\_\_\_\_\_

\_\_\_\_\_

\_\_\_\_\_

\_\_\_\_\_

\_\_\_\_\_

\_\_\_\_\_

\_\_\_\_\_

\_\_\_\_\_



# MEETING 3 PLAN (Den Outing)

## PREPARATION AND MATERIALS NEEDED

- Follow up on the pre-scheduled sporting event the den will attend. Before the event starts, confirm the time, the date, and the person who will be meeting with the den to help the Tigers complete requirement 4.
- Unit den leader should have in possession (if required by local council practices) the tour and activity plan, signed activity consent forms, and a copy of the *Guide to Safe Scouting*.
- Follow up with the members of your Tiger den. Remind them of the information on the flier handed out at the last meeting.
  - Who will attend
  - When you are planning to go
  - Where you will meet
  - Transportation—who will be driving
  - What the Tigers should wear or bring
  - Rules that the Tigers will need to respect when they participate. Remember, “A Scout is courteous.”
- Bring 3-by-5-inch index cards to write questions for the special guest.

## GATHERING

Share with the Tigers some key information about what they will observe and learn during this outing, and field any questions they have about the adventure. Help Tigers prepare a simple greeting, such as each Tiger saying, “Hello, my name is ...”.

It might be helpful to put questions for the special guest on index cards so the boys can keep the cards with them and remember to ask the questions. Also, consider giving them a second card to write questions of their own. Parents can help them form those questions in advance.

## OPENING

- Say the Pledge of Allegiance and, as appropriate, the Scout Oath and Scout Law. If the den does not have a United States flag on the outing, ask one Scout to display the flag on his uniform for the group.

## TALK TIME

- Carry out business items for the den.
- Allow time for sharing among Cub Scouts.

## ACTIVITIES (REQUIREMENT 4)

You should begin the outing by introducing the special guests (athletes, experts, etc.) who will help lead the meeting.

Allow Tigers to greet the guest with an appropriate greeting they have prepared. Remember to say that the Tigers have some questions they would like to ask.

Have the special guests introduce the Tigers to the facility, the team, or anything else they would like to share (e.g., interesting facts or a demonstration by the team). Maybe ask the Scouts to pass out water to the team members during the game.

Watch the sporting event together with adult partners.

## CLOSING

Have the den members thank the person who arranged the outing. To help the boys be courteous, prompt them for ideas about how to do this. Options might include a “thank you” from each boy, handshakes, cheering, or applause. This may also be an opportunity to use their den yell as a means of showing appreciation.

Commend the boys for following the rules of the facility during the outing, and remind them that Scouts are respectful of the rules of any place they enter.

Make sure to address any important plans for the next meeting.

## AFTER THE MEETING

- Record completion of requirement 4.
- Prepare thank-you notes for the Tigers to sign at the next meeting.
- Bringing refreshments to share with the athletes would be a positive gesture.

Upon completion of the Games Tigers Play adventure, your Tigers will have earned the adventure loop shown here. Make sure they are recognized for their completion by presenting the adventure loops, to be worn on their belts, as soon as possible according to your pack's tradition.





# MY FAMILY'S DUTY TO GOD



## RATIONALE FOR ADVENTURE

This adventure will help Tigers understand what duty to God means in Scouting, and also what it means for them and their families.

## TAKEAWAYS FOR CUB SCOUTS

- With their adult partner, discovering their family's faith
- Beginning to strengthen their faith together with other family members
- Observing different ways a person can be reverent
- A Scout is reverent. 

*Tiger Handbook, page 56*

## ADVENTURE REQUIREMENTS

1. With your adult partner, find out what duty to God means to your family.
2. Find out what makes each member of your family special.
3. With your family, make a project that shows your family's beliefs about God.
4. Participate in a worship experience or activity with your family.

## NOTES TO DEN LEADER

This adventure is primarily a family-based adventure. If you would like to hold a portion of it during a den meeting, here is a meeting plan to help you do so.

See the Appendix for optional den meeting activities, including openings, gatherings, and closings.



### Do-at-Home Project Reminder:

For Meeting 1, ask each Tiger, with his adult partner, to collect items from home representing his family's faith. Before the meeting, remind Tigers to bring these items to share with the den if they choose. Requirement 4 will be completed by each family on its own.

# MEETING 1 PLAN

## PREPARATION AND MATERIALS NEEDED

- U.S. and den flags
- Materials for Tigers to make a banner, flag, or coat of arms, including scissors, glue, fabric, paper, and any other items suitable for the project
- Items brought from home by each Tiger and his adult partner representing their family's faith and the unique gifts and talents of their family members
- Read the My Family's Duty to God adventure in the *Tiger Handbook*.

## GATHERING

Have the Tigers display any items that they have brought from home to represent their faith, gifts, or talents.

## OPENING

- Conduct a flag ceremony of your choosing that includes the Pledge of Allegiance and, as appropriate, the Scout Oath and Scout Law. If desired, include a prayer or moment of reflection.

## TALK TIME

- Carry out business items for the den.
- Remind Tigers and adult partners that requirement 4 will be completed by each family on its own.
- Allow time for each Tiger to share about something he brought to the den meeting or to tell everyone something about his family's duty to God or unique gifts or talents (requirements 1 and 2).

## ACTIVITIES

### ◆ Activity 1: Create a Family Banner (Requirement 3)

#### Materials:

- Flag material (muslin works well), 2 feet by 3 feet (small) or 3 feet by 4 feet (large)
- Poles or sticks
  - Make a casing (sew or tape) along the sides of the material to fit the poles (or sticks)
- Acrylic paints
- Markers
- Paint brushes
- Paper towels
- Cups for water
- Table covers
- Markers
- Foam stickers



## CLOSING

- Lead the Tigers and adult partners in the Scout Oath:

**On my honor I will do my best**

**To do my duty to God . . .**

(Pause here. Beginning with yourself, go around the circle and ask each Tiger and adult partner to show or tell an example of what duty to God means to them. Then complete the Oath.)

**. . . and my country and to obey the Scout Law;**

**To help other people at all times;**

**To keep myself physically strong, mentally awake, and morally straight.**

## AFTER THE MEETING

- Make sure all materials from the banner project are cleaned up.
- Serve refreshments, if desired.
- Record advancement completed during the meeting (requirements 1, 2, and 3).

Upon completion of the My Family's Duty to God adventure, your Tigers will have earned the adventure loop shown here. Make sure they are recognized for their completion by presenting the adventure loops, to be worn on their belts, as soon as possible according to your pack's tradition.





# TEAM TIGER



## RATIONALE FOR ADVENTURE

This adventure will introduce Tigers to the concept of teamwork and also to the idea that—even at a young age—they can make a difference in the world. Some of the activities in this adventure are home-based and involve the family and/or the adult partner, and others are to be performed with the den.

## TAKEAWAYS FOR CUB SCOUTS

- Understanding that each Cub Scout is part of many teams and, as such, he can have an impact on his family, his Tiger den, and his community
- A Scout is trustworthy, loyal. 

*Tiger Handbook, page 66*

## ADVENTURE REQUIREMENTS

1. List the different teams of which you are a part.
2. With your den, make a den job chart that shows everyone doing something to help. As one of the den jobs, lead the Pledge of Allegiance at a den meeting.
3. Pick two chores you will do at home once a week for a month.
4. Make a chart to show three ways that members of your Tiger team are different from each other.
5. Do an activity to help your community or neighborhood team.

## NOTES TO DEN LEADER

Meeting 3 will be a den outing to a community services organization. Scouts will brainstorm ideas for the service project during Meeting 1, and they will work out the planning details during Meeting 2. The leader will need to make arrangements with the outing location and confirm the outing plan with families, including transportation and any additional items they need to bring. Make sure a tour and activity plan has been submitted, if required, and activity consent forms are distributed, signed, and collected.

See the Appendix for optional den meeting activities, including openings, gatherings, and closings.

# MEETING 1 PLAN

## PREPARATION AND MATERIALS NEEDED

- U.S. flag and stand for Pledge of Allegiance
- Copy of Den Duty Chart
- A poster displayed in the room listing the 12 points of the Scout Law
- Materials for Gathering game, “Sweep the Floor” (See below for specific items needed.)
- Materials for Activity 2, Magic Shrinking Circle: rope or cord long enough to create a circle in the room that all the Tigers can fit inside
- Read the Team Tiger adventure in the *Tiger Handbook*.

## GATHERING

### “Sweep the Floor” Game

#### Materials:

- 6 or 8 inflated balloons, plus extra inflated balloons in case one pops (Make certain that no one in the den has a latex allergy.)
- Small whisk broom for each boy
- Tape or string that will be stretched to mark the centerline playing area

#### Instructions:

Divide the boys into equal teams. (If needed, an adult partner may fill in until the next Tiger arrives.) Each team begins with the same number of inflated balloons on its side of the line. Then the teams attempt to sweep their balloons across the line to the other side. The game continues until one team has swept all of its balloons to the other side. If a balloon pops, a new balloon must be added to that team's side.

## OPENING

- Conduct a flag ceremony of your choosing that includes the Pledge of Allegiance and, as appropriate, the Scout Oath and Scout Law.

### Tiger Opening Ceremony

Each Tiger holds a poster with a letter on it. After he shouts his letter, his adult partner reads the statement matching the letter.

**ADULT 1:** T is for TEAM, the Tiger team, a boy and his adult partner having fun together.

**ADULT 2:** I is for INTRODUCTION, showing us what Cub Scouting is all about.

**ADULT 3:** G is for GOOD TIMES, having fun together as a den and with your family.

**ADULT 4:** E is for EXPLORING, searching out new things to see and do.

**ADULT 5:** R is for READY, ready for new adventures together as a team.

**ADULT 6:** S is for SHARING, taking time to talk to each other about the fun things we get to do.

If there are more than six boy-adult partner pairs in the den, two boys may hold on to a single poster. Their adult partners would likewise read the explanation together.

## TALK TIME

- Carry out business items for the den.
- Direct the boys' attention to the poster listing the 12 points of the Scout Law. This can be used as a reference to help Tigers who are working on their den duties project or selecting chores to do at home. Remind Tigers that the Scout Law is also found on the back cover of their handbooks.
- Introduce the “team” concept to the Tigers by using the examples of a sports team, their den, family, etc., and share that the den will learn about the teams they belong to in den activities at this meeting.
- With assistance from the adult partners, help Tigers make a list of potential locations for the community service outing at the next den meeting. Discuss where they can go to learn about service teams in their community. Some examples of city or community services that depend on teamwork: public libraries, police stations, fire stations, recycling centers, Habitat for Humanity, U.S. Forestry Service, state park service, National Park Service, city parks and recreation department, city utilities (water department, waste water treatment plant), county health department, and soup kitchens and food banks.



## ACTIVITIES

### ◆ Activity 1: Tiger Teams (Requirement 1)

With his adult partner, each Tiger should tell the den about any teams he belongs to; then he should list those teams in the *Tiger Handbook*. Remind Tigers that not all teams are related to sports. A team can consist of buddies playing together, a Tiger den, and a family—all of these groups might work together to complete a task.

### ◆ Activity 2: Magic Shrinking Circle

**Materials:** rope or cord to form a large circle which becomes smaller as each phase of the activity is completed

#### Instructions:

1. Explain to the Tigers that you have a magic shrinking circle, and they must all fit inside. For the first round, be sure the circle is large enough to accommodate all members of the den easily.
2. Once they are all inside, the next round will begin. Make the circle smaller, but tell the members they must still find a way to fit inside.
3. Continue this cycle until the circle becomes so small it is impossible for everyone to fit. Be sure to let the Tigers work through this exercise as a team without adult guidance, unless they need it.
4. Once the activity is complete, ask the boys if the challenge of making themselves “fit” into a smaller area each time worked better if they shared ideas as a team or if only one member of the den told them how to do it. Guide them in a discussion about what might have been done differently, whether they feel they finished the game, etc.

### ◆ Activity 3: Den Duty Chart (Requirement 2)

The Tiger Duty Chart should incorporate teamwork as Tigers share responsibilities to complete tasks at each den meeting. Guide the boys in deciding how to work as a team, whether they are setting up the room for the meeting; cleaning up after an activity; leading the Pledge of Allegiance, the Scout Oath, and the Scout Law; or anything else. (See Meeting 1 Resources.)

## CLOSING

- Tigers form the Living Circle (see Appendix page A-22) and recite the Scout Law together.



### Do-at-Home Project Reminder:

Remind Tigers and adult partners that the boys are to pick two chores to do at home once a week for a month (requirement 3). These chores will be shared with the den at their next den meeting.

## AFTER THE MEETING

- Serve refreshments, if desired.
- Make sure everything is cleaned up.
- Update the Duty Chart to record tasks completed at the meeting.
- Record advancements at the meeting for requirements 1 and 2.
- Choose a community service office or agency the Tigers can visit with their adult partners for the den outing. See Talk Time for a list of possibilities. Be sure to plan a date that fits everyone’s schedule, arrange for transportation, complete a tour and activity plan, if required, and distribute activity consent forms to be signed and returned.

# MEETING 1 RESOURCES

## TIGER DUTY CHART

### Week 1 Duty Chart

Duty	Tiger in Charge	Completed

### Week 2 Duty Chart

Duty	Tiger in Charge	Completed

### Week 3 Duty Chart

Duty	Tiger in Charge	Completed

# MEETING 2 PLAN

## PREPARATION AND MATERIALS NEEDED

- U.S. and den flags
- Paper bags labeled with the first initial of each Tiger in the den; small items for each bag that begin with the same letter
- Copies of the “Diversity Scavenger Hunt” list (one for each boy and adult partner); pencils for each participant
- Pre-cut strips of paper for the charades game and a bowl or container to put them in
- Flier for the Meeting 3 den outing

## GATHERING

Label each paper bag with the first letter of each Tiger’s name, and put objects in the bag that start with that letter. For example, a bag labeled “J” could contain a toy jet, a bag marked “M” might hold a mug, or a yo-yo could be found in a “Y” bag. Before each bag is opened, all the players try to guess what’s in it by feeling the outside of the bag first.

## OPENING

- Conduct a flag ceremony of your choosing that includes the Pledge of Allegiance and, as appropriate, the Scout Oath and Scout Law.
- Tiger Roll Call Opening: As the den meeting host calls roll, each Tiger responds with a loud tiger growl.

## TALK TIME

- Carry out business items for the den.
- Have each Tiger tell the den about the two chores he selected to do at home for the month. (Do-at-Home Project from Den Meeting 1)
- Ask the group what happens when a den member is absent, or when people in their families get sick or hurt and cannot do their chores. How can a Tiger help out in those situations? Remember, a Scout is trustworthy and loyal. His fellow den members can count on his being there to do his job, or he will let them know if he can’t so someone else can pitch in.
- Change the Den Duty jobs for the week.

## ACTIVITIES

### ◆ Activity 1: Diversity Scavenger Hunt (Requirement 4)

The goal of this activity is to observe others around us and acknowledge that, while we are similar, we are still different from each other. The items on the list can be changed as needed to fit your den. See Meeting 2 Resources for a sample. To conclude this activity, find out what each Tiger learned about the others. You can choose to chart the results or simply have a brief conversation.

### ◆ Activity 2: Charades

Each Tiger and adult partner will draw a piece of paper from the bowl or container and act out whatever is written on it. They can only use movements and gestures—no words—while the other den members try to guess it correctly. To make this game age-appropriate for Tigers, one category could be, “What do you do before going to school?” (brush teeth, comb hair, put on shoes, eat breakfast, etc.). Another fun option: “Which animal am I?” (a snake slithering on the ground, a bird flying or digging for worms, a dog burying a bone, etc.).

### ◆ Activity 3: Service Activity Planning (Requirement 5)

1. As a den, select a service project if the den did not make a final choice in Meeting 1 following the brainstorming activity. Make plans for the project to help your chartered organization, community, or neighborhood. The activity could be as simple as weeding, planting flowers, picking up trash, or collecting food or coats for people in need.
2. Plan a date to complete the project if it cannot be finished during a den meeting or the den outing.

## CLOSING

- Recite the Scout Law
- Have each Tiger decide on a point in the Scout Law they will try to focus on between this meeting and the next.
- Review details for the Den Meeting 3 outing. Make sure all Tigers and their families know the plans.

## AFTER THE MEETING

- Serve refreshments, if desired.
- Make sure everything is cleaned up.
- Record advancements at the meeting for requirement 4.
- Remind Tigers and adult partners about the den outing. Collect activity consent forms and cover all important information related to the outing.

## MEETING 2 RESOURCES

### DIVERSITY SCAVENGER HUNT

Each boy and/or adult partner will talk to others in the den to identify the following:

1. Someone who is taller than I am \_\_\_\_\_
2. Someone who is wearing a watch \_\_\_\_\_
3. Someone who has a pet dog \_\_\_\_\_
4. Someone who has a birthday close to mine \_\_\_\_\_
5. Someone wearing black shoes \_\_\_\_\_
6. Someone who wore a hat to the den meeting \_\_\_\_\_
7. Someone who has a brother \_\_\_\_\_
8. Someone who plays a sport \_\_\_\_\_



# MEETING 3 PLAN (Den Outing)

## PREPARATION AND MATERIALS NEEDED

- Unit den leader should have in possession (if required by local council practices) the tour and activity plan, signed activity consent forms, and a copy of the *Guide to Safe Scouting*.
- Identify a lead person at the community service office or agency who will give the den a tour and answer questions about what the team does and how team members work together.

## GATHERING

- Remind the Tigers about behavior expectations while on the den outing. Use examples from the Scout Law where you can (e.g., courteous, friendly, helpful).
- Explain to the Tigers and their adult partners any rules or regulations for the outing.
- In a den roll call, give each Tiger a number, and tell him to remember it for the closing activity.

## OPENING

- Say the Pledge of Allegiance and, as appropriate, the Scout Oath and Scout Law. If the den does not have a United States flag on the outing, ask one Scout to display the flag on his uniform for the group.
- Ask Tigers to recite the 12 points of the Scout Law. Remind them that a Scout is courteous and that, as guests during the den outing, they will have a great opportunity to practice that part of the Scout Law.

## TALK TIME

- Carry out business items for the den.
- Ask the boys to think about this question while they are on the tour: What things can they do to help this community servant do his or her job? Prepare by brainstorming ideas that relate to the facility.
- Introduce the den to the community service contact who is guiding the tour. An appropriate greeting the Tigers could offer might be as simple as, "Hello, my name is..." Tell the guide at this time that the boys have some questions they would like to ask when the session is over.

## ACTIVITIES

### ◆ Activity 1: Community Services Agency Visit

When making arrangements, find out if the Scouts will be able to tour a facility or take part in a Q-and-A session with staff members. If so, tell the contact person ahead of time that the questions will focus on:

- How do staff members carry out the duties of their positions?
- How are staff members helpful to the community?
- How can Scouts be helpful in their community by knowing what to do in special situations, such as an emergency in their homes?

## CLOSING

- Gather the Tigers and do a roll call. This time, call the numbers backward to see if each Tiger remembers his number from the start of the meeting.

## AFTER THE MEETING

- Prepare thank-you notes for those who helped with the outing.
- Be sure to give the boys positive feedback on their behavior during the outing.

Upon completion of the Team Tiger adventure, your Tigers will have earned the adventure loop shown here. Make sure they are recognized for their completion by presenting the adventure loops, to be worn on their belts, as soon as possible according to your pack's tradition.





# TIGER BITES



## RATIONALE FOR ADVENTURE

This adventure will introduce or reinforce healthy eating habits, including making the right food choices and practicing good hygiene. Activities will also focus on good manners at mealtime. In addition, the adventure will give each Tiger an opportunity to perform a useful service for his family.

## TAKEAWAYS FOR CUB SCOUTS

- Making healthy food choices
- Trying new fruits and vegetables
- Developing manners when eating
- Practicing basic food-related hygiene
- A Scout is clean, helpful, courteous. 

*Tiger Handbook, page 78*

## ADVENTURE REQUIREMENTS

1. Identify three good food choices and three foods that would not be good choices.
2. Show that you know the difference between a fruit and a vegetable. Eat one of each.
3. With your adult partner, pick a job to help your family at mealtime. Do it every day for one week.
4. Show you can keep yourself and your personal area clean.
5. Talk with your adult partner about what foods you can eat with your fingers. Practice your manners when eating them.
6. With your adult partner, plan and make a good snack choice or other nutritious food to share with your den.

### NOTES TO DEN LEADER

Meeting 3 will be a den outing to a grocery store, farmer's market, or farm. In advance of the outing, the leader will need to make arrangements with the outing location and confirm the outing plan with families, including transportation and any additional items they need to bring. Make sure a tour and activity plan has been submitted, if required, and activity consent forms are distributed, signed, and collected.

See the Appendix for optional den meeting activities, including openings, gatherings, and closings.

## MEETING 1 PLAN

### PREPARATION AND MATERIALS NEEDED

- Materials for Gathering game: 5 (or more) paper lunch bags each containing a fruit or vegetable
- Materials for relay game: 2 plastic cups; 1 paper plate; plastic fork, knife, and spoon (1 set per boy); 1 copy per Tiger of the polite/impolite manners cards, cut into squares
- With the adult partners, determine if any of the Tigers or their parents has food allergies.
- Read the Backyard Jungle adventure in the *Tiger Handbook*.

## GATHERING

Set out the five different lunch bags on one surface. As the boys arrive, invite them to reach into the bags without looking inside. Have them guess the fruit or vegetable in each bag, while adult partners record their guesses. Choose a nice range of fruits and vegetables for the bags—not limited to the most common choices.

## OPENING

- Conduct a flag ceremony of your choosing that includes the Pledge of Allegiance and, as appropriate, the Scout Oath and Scout Law.
- Optional Opening: Invite the boys and their adult partners to form a circle. Recite the Pledge of Allegiance and the Scout Oath with support from partners. Invite the boys to give a big Tiger growl in unison. Then ask them to give a Tiger growl as if the tiger were hungry.

## TALK TIME

- Introduce the Tiger Bites adventure to the den. Build interest by describing the goals of the adventure and some of the activities that are planned.
- Carry out business items for the den.
- Share with Tigers and adult partners that they will complete requirements 3 and 6 at home. Explain that the snack in requirement 6 only needs to be enough for everyone to taste if all the Tigers are bringing their snacks to the same den meeting.
- Now that everyone has made their guesses in the Gathering activity, reveal what was in each bag.
- Ask the Tigers what all the items from the bags have in common. See if the Tigers can name all the items, and ask if they have eaten those fruits or vegetables before. This is a brief sharing time, so allow each Tiger a moment to tell what he knows about fruits and vegetables.
- Have an adult partner prepare these fruits and vegetables for tasting later in the meeting. Tell the Tigers that they will have some “Tiger Bites” to try at the end of the meeting!

## ACTIVITIES

### ◆ Activity 1: “Up and Down” Game

Play the game “Up and Down” to help Tigers recognize fruits and vegetables and where they grow.

1. Have Tigers stand next to their adult partners in a circle. One at a time, call out the names of fruits or vegetables that grow either above or below the ground. For example, strawberries grow above the ground, but potatoes grow below. When you call a fruit or vegetable that is found above the ground, the players stand; if it’s found below, they sit down. Keep the game quick and lively. Encourage the partners to help Tigers if they are unsure.
2. Suggested fruits and vegetables to call include apples, potatoes, carrots, oranges, strawberries, radishes, tomatoes, grapes, and any others you may want to add. If a specific fruit or vegetable is common to your area, be sure to include it as well.
3. You can also call out different hygiene habits to make the game a little more challenging. Tigers stand if the habit is a good one; they sit if it is not good. Use habits such as: washing hands before handling food, washing hands after going to the restroom, drinking out of someone else’s glass, having dirty fingernails, washing your hair, not brushing your teeth, making sure your cooking area is clean, not throwing away used tissues, taking a bath or shower, not covering your mouth when you sneeze or cough.



## ◆ Activity 2: Know Your Fruits and Vegetables (Requirement 2)

1. Examine the difference between a fruit and a vegetable. Let the boys touch some sample fruits and vegetables to find which ones have seeds and which ones do not. Provide enough samples so that the den can be divided into two teams.
2. Have each team take about five minutes to decide which samples are fruits and which ones are vegetables. Remind them that fruits have seeds and vegetables do not. Present them with some challenging foods such as cucumbers, avocados, or tomatoes.
3. After five minutes of exploration time, talk about the differences between fruits and vegetables. If the samples have not been cut open, do so now to demonstrate those with seeds and those without.
4. Have the boys wash their hands so they can try out the different fruits and vegetables. Allow each Tiger to taste at least one fruit and one vegetable.

### CLOSING

- Gather the Tigers in a circle. Using a ball, gently toss it to each boy, asking him to name one fruit, vegetable, or polite manner. When everyone has had a turn, close the meeting with Tiger growl, in unison, to show how happy the tiger is after his “Tiger Bites.”



#### **Do-at-Home Project Reminder:**

Hand out the Do-at-Home Project that needs to be completed before the next meeting. (See Meeting 1 Resources.) Tigers will assist with meal preparation, bring a nutritious snack to share, and practice good hygiene during food preparation.

### AFTER THE MEETING

- Clean up after everyone has finished with the fruits and vegetables.
- Record advancements at the meeting for requirement 2.

# MEETING 1 RESOURCES



## Do-at-Home Project:

The activities below will be completed at home in preparation for the next den meeting. Enjoy this activity with your Tiger, and help him achieve the requirements as noted for this adventure.

### Mealtime Preparation Job (Requirement 3)

Help your Tiger observe and/or participate in the jobs that need to be done when preparing a meal. After he has observed, allow him to choose a specific job he would like to assist in for one week. Create a mealtime job chart for him to keep a record of his work during the week.

### Snack Sharing Activity (Requirement 6)

Get together with your Tiger, and discuss what might be a good, nutritious snack to prepare and share with the den during the next meeting. Ideas include:

- Create a smoothie using 2 bananas, 2 cups of strawberries, 1 cup of milk, and 1 cup of yogurt.
- Ants on a log: Put peanut butter, cream cheese, or pimento cheese on a celery stick, and then put raisins on the topping so it looks like ants walking on a log.
- Spread cream cheese on a tortilla (hard or soft shell) or a graham cracker. Then add fruit or veggie slices to create a face.
- Cut up your favorite fruits for a fruit salad. Serve it on a piece of lettuce.
- Find or invent your own healthy snack!

After you've discussed ideas, agree upon one snack, and plan how that snack will be prepared. Take the snack to the next den meeting to share with other Tigers.

### Food Preparation Hygiene (Requirement 4)

While preparing the snack, be sure to practice good hygiene. Encourage your Tiger to show how he can keep himself and his personal area clean.



# MEETING 2 PLAN

## PREPARATION AND MATERIALS NEEDED

- U.S. and den flags
- “Made From Corn” list for Gathering (See Meeting 2 Resources.)
- Activity 2 Table Manners Relay cards (See Meeting 2 Resources.)

## GATHERING

Print out or write the list of items from the Meeting 2 Resources, and cut it into strips of paper. Set up two pieces of chart paper on the floor, one marked “MADE FROM CORN” and the other marked “NOT MADE FROM CORN.” Ask the boys to place each strip of paper onto the chart paper they believe is correct. If an item can be made from corn (even if it is not always or entirely made from corn), drop it in the “MADE FROM CORN” cup. Adult partners can help to read or explain as needed. At the end, reveal that ALL of the things listed on the strips can be made from corn.

## OPENING

- Conduct a flag ceremony of your choosing that includes the Pledge of Allegiance and, as appropriate, the Scout Oath and Scout Law.
- **Tiger Opening Ceremony:** Write the statements below on posters or cards for the adult partners to read. Have each Tiger hold a poster with one of the letters on it. After he shouts his letter, his adult partner will read the statement matching the letter.

**ADULT 1:** T is for TEAM, the Tiger team, a boy and his adult partner having fun together.

**ADULT 2:** I is for INTRODUCTION, showing us what Cub Scouting is all about.

**ADULT 3:** G is for GOOD TIMES, having fun together as a den and with your family.

**ADULT 4:** E is for EXPLORING, searching out new things to see and do.

**ADULT 5:** R is for READY, ready for new adventures together as a team.

**ADULT 6:** S is for SHARING, taking time to talk to each other about the fun things we get to do.

## TALK TIME

- Carry out business items for the den.
- Remind everyone that the next meeting will take place at a local grocery store or other predetermined place, such as a farmer’s market or a farm. Give the time, as well as the place where everyone should plan to meet. Remind the Tigers to arrive in uniform!

## ACTIVITIES

### ◆ Activity 1: Mealtime Job Chart

Have each Tiger share his completed mealtime job chart from their Den Meeting 1 Do-at-Home Project. Sample questions to ask include:

- What did you like best about doing this job during the week?
- What was difficult?
- Would you like to continue to do it, or change and do something else?
- Why do you think it is important to help out at home?
- How did it make you feel to know that you were helping your family?

## ◆ Activity 2: Play “Table Manners Relay” (Requirement 5)

**Materials:** manners cards (See Meeting 2 Resources.)

Have each adult partner hand his Tiger a plate labeled “Polite Manners,” a cup marked “Impolite Manners,” and silverware. The Tiger will run to the finish line and set the “table” with his supplies.

He will then run back to his adult partner, who will draw a card from the ones given for the game. Together, they will decide if the action on the card is polite or impolite. Once they have decided, the Tiger will run to the table and place the card where it belongs—on the plate or in the cup.

The relay continues until all cards have been placed. The first team to finish placing their cards wins!

## ◆ Activity 3: Nutritious Snack Sharing

Invite Tigers and their adult partners to tell about the snack items they brought to share with the den. Remind Tigers of good manners for eating finger foods, and encourage them to try a variety of snacks—especially those that are new to them.

### CLOSING

- Remind everyone of the outing planned for the next meeting, when they will go to a local grocery store, farmer’s market, or farm.
- Make sure all Tigers and their families know the plans.

### AFTER THE MEETING

- Record completion of requirements 3, 4, 5, and 6.
- Work together to clean up the meeting place.

## MEETING 2 RESOURCES

### Made From Corn Game List

Baby foods

Cosmetics

Paints

Batteries

Crayons

Paper

Candy

Diapers

Paste and glue

Canned/frozen corn

Dyes

Plastics

Ceramics

Fireworks

Safety glass

Chalk

Glue

Salad dressings

Chewing gum

Hominy and grits

Soaps

Cooking oil

Insecticides

Sweeteners

Corn syrup

Margarine

Textiles

Corn flakes

Matches

Toothpaste

Cornmeal

Medicines

Varnishes

Cornstarch

Rubber tires

Vinegar

## Table Manners Relay Cards

<b>GOOD MANNERS</b>	<b>POOR MANNERS</b>
Saying "please" and "thank you"	Chewing with your mouth open
Washing your hands before eating	Keeping your elbows on the table during mealtime
Using a napkin or plate when eating finger foods	Dipping a chip again when it is half-eaten
Chewing food with your mouth closed	Letting crumbs fall on the floor instead of onto your napkin
Asking to be excused before leaving the table	Not using a napkin at mealtime
Using serving utensils instead of your hands	Reaching across the table for food without asking someone to pass it to you
Remembering not to slurp, smack your lips, or blow your nose at mealtime	Starting to eat before everyone has been served
Asking if you can help clear dinner plates	Telling the cook you don't like the food

# MEETING 3 PLAN (Den Outing)

## PREPARATION AND MATERIALS NEEDED

- Select a local grocery store, farmer's market, or farm to visit. (The scavenger hunt may not be possible if the den visits a farm, but a tour there would be just as interesting.)
- Unit den leader should have in possession (if required by local council practices) the tour and activity plan, signed activity consent forms, and a copy of the *Guide to Safe Scouting*.
- Copies of the "Grocery Scavenger Hunt" chart for Activity 1 (See Meeting 3 Resources.)

## GATHERING

As the Tigers arrive, invite them to try some traditional tongue twisters such as—

*Peter Piper picked a peck of pickled peppers.*

*Did Peter Piper pick a peck of pickled peppers?*

*If Peter Piper picked a peck of pickled peppers,*

*Where's the peck of pickled peppers Peter Piper picked?*

Another choice: *Freshly fried flying fish.*

Or have them try to solve these funny food riddles:

- What did the baby corn say to the mama corn? (Where's pop corn?)
- What did the nut say when it sneezed? (Cashew!)
- Why was the cucumber mad? (Because it was in a pickle!)
- What bird is with you at every meal? (A swallow!)
- Why did the banana go to the doctor? (Because it wasn't peeling well!)
- What do you call a shoe made from a banana? (A slipper!)
- What does a mixed-up hen lay? (Scrambled eggs!)
- What do you call a bear with no teeth? (A gummy bear!)
- Why do seagulls fly over the sea? (Because if they flew over the bay they would be called bagels!)

## OPENING

- Say the Pledge of Allegiance and, as appropriate, the Scout Oath and Scout Law. If the den does not have a United States flag on the outing, ask one Scout to display the flag on his uniform for the group.
- Gather the Tigers together in a circle, and recite the Scout Law. Ask them to listen for any words that describe how they should act during their outing. Accept all answers. If they have trouble remembering, you can prompt them with any of these: courteous, kind, obedient, cheerful, helpful, friendly.

## TALK TIME

- Carry out business items for the den.

## ACTIVITIES

### ◆ Activity 1: Grocery Scavenger Hunt

**Materials:** pencils or markers; scavenger hunt cards (See Meeting 3 Resources.)

1. Just as real tigers need to hunt for their food, these Tigers are going on a hunt. Divide everyone into teams, or pair each boy with his adult partner. (Partners should adjust their level of assistance to the boy's reading ability.)
2. Give each team or pair a grocery scavenger hunt card to fill out during the hunt. Tigers will find one food that fits in each box for the five categories (grains, vegetables, etc.) Then Tigers will identify good choices and poor choices. First, allow them to look over the cards so you can answer any questions. Then announce how much time they have to complete their cards, and let the game begin!
3. As den leader, keep track of the time, and monitor each group as they move around the store, market, or farm.
4. When time is up, have the boys gather with their hunt cards to share their findings. The cards will help Tigers separate good food choices and not-so-good choices.
5. Be ready to suggest a few other foods, and ask them to categorize each suggestion as "nutritious" or "not nutritious." (Here are some examples: Nutritious—a can of soup or beans, a bag of rice, dried fruit, tuna, or cheese. Not nutritious—chocolate syrup, french fries, cupcakes, candy, donuts, or fast-food burgers.)

### ◆ Activity 2: Exploration

If time allows, invite the Tigers and their adult partners to further explore the facility together.

## CLOSING

- If someone from the facility has been helping or showing the Tigers around, be sure to thank him or her.
- When all Tigers have completed the hunt, acknowledge their fine work.
- The meeting will end the same way it began, with the Tigers in a circle. Before each Tiger leaves, name a category from the hunt, and have the Tiger tell you the matching food item.

## AFTER THE MEETING





- Prepare thank-you notes for those who helped with the outing.
- Record completion of requirement 1 and those completed at home.

Upon completion of the Tiger Bites adventure, your Tigers will have earned the adventure loop shown here. Make sure they are recognized for their completion by presenting the adventure loops, to be worn on their belts, as soon as possible according to your pack's tradition.



# MEETING 3 RESOURCES

## FOOD SCAVENGER HUNT

 GRAINS	 VEGETABLE	 FRUIT	 DAIRY	 PROTEIN
A lunch grain:	One you have never seen before:	One you have never seen before:	A dairy product that is a solid (not liquid):	One you have never tried before:
A snack:	One that is grown near you:	One that is grown far away:	Your favorite:	Your favorite:

On all the foods that you have found, put a happy face on the foods that you think are good, healthy choices.



Put a sad face on those that are not good choices.

Find two other foods that you love to eat:

\_\_\_\_\_ , \_\_\_\_\_

Find two foods that are interesting to you because you like the color, the shape, the smell, or the size:

\_\_\_\_\_ , \_\_\_\_\_





# TIGERS IN THE WILD



## RATIONALE FOR ADVENTURE

Tigers will learn how to put the “outing” in Scouting with this outdoor adventure. They will start to develop an understanding of the Outdoor Ethics program as they are introduced to many skills that will be important throughout their Scouting careers.

## TAKEAWAYS FOR CUB SCOUTS

- Cub Scout Six Essentials
- Plant and animal identification
- Outdoor Ethics awareness
- A Scout is obedient, thrifty.



*Tiger Handbook, page 92*

## ADVENTURE REQUIREMENTS

1. With your adult partner, name and collect the Cub Scout Six Essentials you need for a hike. Tell your den leader what you would need to add to your list if it rains.
2. Go for a short hike with your den or family, and carry your own gear. Show you know how to get ready for this hike.
3. Do the following:
  - a. Listen while your leader reads the Outdoor Code. Talk about how you can be clean in your outdoor manners.
  - b. Listen while your leader reads the Leave No Trace Principles for Kids. Discuss why you should “Trash your Trash.”
  - c. Apply the Outdoor Code and Leave No Trace Principles for Kids on your Tiger den and pack outings. After one outing, share what you did to demonstrate the principles you discussed.
4. While on the hike, find three different kinds of plants, animals, or signs that animals have been on the trail. List what you saw in your *Tiger Handbook*.
5. Participate in an outdoor pack meeting or pack campout campfire. Sing a song and act out a skit with your Tiger den as part of the program.
6. Find two different trees and two different types of plants that grow in your area. Write their names in your *Tiger Handbook*.
7. Visit a nearby nature center, zoo, or another outside place with your family or den. Learn more about two animals, and write down two interesting things about them in your *Tiger Handbook*.

### NOTES TO DEN LEADER

Meeting 3 will be a den outing for a hike and visit to a nature center, zoo, or other outdoor place. In advance of the outing, the leader will need to make arrangements with the outing location and confirm the outing plan with families, including transportation and any additional items they need to bring. Make sure a tour and activity plan has been submitted, if required, and activity consent forms are distributed, signed, and collected.

You will want to record completion of requirement 5 following participation in the campfire or outdoor event. This doesn't have to be at the same time the den completes this adventure.

See the Appendix for optional den meeting activities, including openings, gatherings, and closings.

# MEETING 1 PLAN

## PREPARATION AND MATERIALS NEEDED

- U.S. and den flags
- Trail food options (pretzels, seeds, nuts, raisins, dried fruit, crackers, chocolate chips, etc.), spoons or scoops, and a zippered storage bag for each Tiger and adult partner
- Materials for Cub Scout Six Essentials (requirement 1)
  - Include a small fanny pack, backpack, or similar bag for storage; first-aid kit; water bottle; flashlight; trail food; sun protection; and whistle.
  - Also bring some obviously “non-essential” items to demonstrate what SHOULDN’T be included (e.g., a heavy hammer, an oversized flashlight, a TV remote, etc.)
  - Decide how your Tigers will assemble the Six Essentials. Each boy should eventually have his own set. Donations, bringing items from home, or purchasing new items are all possible options for collecting them.
- Skit materials or props if needed
- Balloon volleyball or soccer: balloons, rope
- Prepare a flier for families with information about the upcoming outing.
- Read the Tigers in the Wild adventure in the *Tiger Handbook*.

## GATHERING

Have trail food options available (see above) and a zippered storage bag for each Tiger and his adult partner. Allow Tigers to mix their own trail food according to their taste. Label the bags, and store them for the hike. While Tigers are creating their trail mix, remind them of the reasons they need to have food on the hike.

### NOTE TO DEN LEADER

Be aware of allergies in your group, and make adjustments as needed. Before Tigers handle food, encourage them to wash their hands.

## OPENING

- Conduct a flag ceremony of your choosing that includes the Pledge of Allegiance and, as appropriate, the Scout Oath and Scout Law.

## TALK TIME

- Introduce the Tigers in the Wild adventure to the den. Build interest by describing the goals of the adventure and some of the activities that are planned.
- Carry out business items for the den.
- Distribute information on the location for your hike for Den Meeting 3. Have everyone plan to meet at the location, or arrange for carpooling as needed.
- Briefly discuss Outdoor Ethics as a refresher before getting started. Remember that wilderness conservation depends on understanding and respecting “the wild.” The Boy Scouts of America has long had a commitment to outdoor ethics and conservation practices.

## ACTIVITIES

### ◆ Activity 1: Kim’s Game (Requirement 1)

#### NOTE TO DEN LEADER

This is a great Scouting heritage game. For more information on the game’s literary namesake, see the novel *Kim* by Rudyard Kipling. Kipling was a contemporary of Lord Baden-Powell, the British officer who started the Scouting movement. It is said that this game was a favorite of Baden-Powell to play with his Scouts.

1. Play Kim's Game with the Cub Scout Six Essentials, plus six other items. Once the game is done, have the group decide which six items they should carry with them on the hike or anytime they are at a Scout event. Steer them toward the Cub Scout Six Essentials, and discuss how each one is used. Be sure to emphasize that the whistle is ONLY for emergencies.
  - a. Spread out a number of items on a tabletop, and cover them with a towel. (There should be more items than the players can be expected to remember.)
  - b. Provide each Tiger and adult partner with a pencil and paper. Explain that you are going to give them one minute to review what's under the towel. Remove the towel. After one minute, cover the items again.
  - c. Let each Tiger, individually, dictate to his adult partner as many of the items as he can remember. Then have the boys team up in pairs, and give each pair one more minute to try recalling more of the items. Remember, only the Tigers—not their adult partners—can dictate the lists.
  - d. After the second minute, remove the towel and see who listed the most correct items. They probably did better when they teamed up than they did individually. Did the group, as a whole, get all the items?
2. Discuss with the den how the list of items might change if you were going on an all-day hike. For example, what would we add if we thought it might rain? Remind Scouts that leaders would monitor the weather for any dangers, but in the case of a light rain or other mild weather changes, they would want to be prepared to keep hiking.

### ◆ Activity 2: Tiger Skits (Requirement 5)

Choose a skit, and practice it for an outdoor pack meeting or campfire. (See below for ideas.) Remind Tigers that a Scout is cheerful, and a way to show this is by being happy and making others laugh.

#### **"Emergency Alert System" Skit**

All the Tigers but one stand in a line. The "leader" stands in front or off to one side.

**Leader:** For the next 10 seconds, we will be conducting a test of the emergency broadcast system. (Tigers all make a "Beeeeeeeeeeeeeeep" sound until the leader raises his hand.)

**Leader:** Thank you. This concludes the test of the emergency broadcast system. Had this been an actual emergency, you would have heard...

(Tigers scream in panic and run around, then leave the stage.)

#### **Sitting on a Bench Skit**

Tiger #1 walks on stage and squats down as if he is sitting on a bench that is invisible. Several more Tigers stand off to the side.

**Tiger #2** (walks up to Tiger #1): Whatcha doin'?

**Tiger #1:** Just sitting on this invisible bench.

**Tiger #2:** Can I join you?

**Tiger #1:** Sure!

(Tiger #2 sits down next to #1. More Tigers enter the stage, one boy at a time; the dialogue and action is repeated, until a long line of Tigers is sitting on the invisible bench. Then the last Tiger walks out.)

**Last Tiger:** What are you guys doing?

**All:** Just sitting here on this invisible bench.

**Last Scout:** No, you aren't. (Points to a distant spot.) I moved the bench over there.

(All the "sitting" Tigers fall down.)

### ◆ Activity 3: Balloon Volleyball Game

Play balloon volleyball or balloon soccer. Set a specific goal, and divide the Tigers into two teams that will bat the balloon back and forth with either their hands (volleyball) or feet (soccer).

**Option 1:** Balloon volleyball is played like regular volleyball, but it can be played indoors. Players bat the balloon back and forth over a rope tied between two chairs or two doorjambs, etc. Increase the number of hits allowed per side if the group has difficulty playing.

**Option 2:** Balloon soccer can be played indoors or out and is played like regular soccer. Reduce the playing area if needed.

### CLOSING

Remind Tigers of the lessons learned from Kim's Game: Two heads are better than one, and we always use the buddy system in Scouting.



#### Do-at-Home Project Reminder:

Ask each Tiger to observe wildlife around his home and make a list of what he sees. You may also want to ask Tigers to bring leaves for the leaf-rubbing activity at the next meeting. The leaves should not be picked, but should be freshly fallen. If Tigers have a pet at home, tell them to draw a picture of its paw and bring the picture to the next meeting.

### AFTER THE MEETING

- For refreshments, serve the trail food from earlier in the meeting.
- Clean up as needed.
- Record completion of requirement 1.

## MEETING 2 PLAN

### PREPARATION AND MATERIALS NEEDED

- U.S. and den flags
- Materials for plant and animal identification.
  - Research plants and animals in your local area, or find someone who can assist with identification. Local nature centers or federal agencies (Bureau of Land Management, National Forest or Grassland offices, etc.) should have information. There are numerous books on the subject as well; books in color and with detailed photos or illustrations will work best.
- Several different types of leaves for the leaf-rubbing activity (with photos for identifying them), crayons, paper, etc.
- Material to make marble bags—denim, leather, canvas, or any thick fabric that can be laced into a bag or pouch and hold the weight of marbles.
- Animal print samples from household pets or common local animals for the “Name This Animal” activity

### GATHERING

Have Tigers make a simple marble bag. If time permits, the Tigers can draw animal prints using as a guide the resources you collected. (See Meeting 2 Resources.)

#### NOTE TO DEN LEADER

Make a sample marble bag for yourself before the meeting so you will have one to display and you will understand the process.

### Materials (for each Tiger):

- Denim, an old shirt, artificial leather, or similar material for cutting out a 12-inch circle
- 1 shoelace with tips on the ends
- Markers, fabric paint
- Scissors
- 10–12 marbles



### Instructions:

1. Cut out a 12-inch circle from the material. Cut with pinking shears, if you have them, but regular scissors will work as well.
2. Label and decorate, as desired, the side that will be the exterior of the bag.
3. Mark an even number of small holes around the outer edge of the material, about 1 inch in from the edge to prevent tearing. Then punch or cut the holes just wide enough for the shoelace to pass through.
4. Starting on the exterior side, thread the shoelace through all the holes. Using your fingers, shape the circle into a bag, and tighten the laces.
5. Put the marbles in the bag, and tie the shoelace ends together. You are ready to play marbles!

### OPENING

- Conduct a flag ceremony of your choosing that includes the Pledge of Allegiance and, as appropriate, the Scout Oath and Scout Law.

### TALK TIME

- Carry out business items for the den.
- Discuss your upcoming hike or tour.
- Discuss plans for your visit to a nature center or other destination. Ask boys to suggest what plants and animals they might see there (preparation for requirement 7).
- Read aloud the Outdoor Code and the Leave No Trace Principles for Kids. (Both can be found at the back of the Tigers' handbooks.) Then have Tigers recite them with you. Discuss what it means to be clean in your outdoor manners and to "trash your trash." Tell Tigers that they will focus on those principles for this adventure during their upcoming outing (requirements 3a and 3b).

### ACTIVITIES

#### ◆ Activity 1: Leaf Rubbings (Requirement 6)

Have the Tigers make rubbings of the leaves they brought. Perform a demonstration to help them learn the technique. Remind boys that they can use any colors. Have some extra samples on hand to make sure there will be different types of leaves for them to compare.

To make a leaf rubbing:

1. Lay the leaves on a piece of plain white paper. Be sure the veins are facing up. The more variety you have in the shapes and vein patterns, the more interesting the rubbings will be.
2. Lay another sheet of plain white paper on top of the leaves.
3. Choose a crayon and peel off the paper wrapper.
4. Using the side of the crayon, gently rub over the top sheet of paper.
5. Try different colors and leaf arrangements, and enjoy the beautiful pictures your Tigers create!

Using leaf rubbings and the actual leaves, have the den identify the leaves. Point out the characteristics of each leaf.

## ◆ Activity 2: Animal Prints

Identify the animal prints brought in by the boys as part of the Do-at-Home Project from Den Meeting 1 or done during the Gathering. (See Meeting 2 Resources.) Ask each Tiger to share the list of animals he observed, and any facts he learned about them. It would also be a good idea to have some facts ready to share about the wildlife in your area.

## ◆ Activity 3: Play a Game of Marbles (Optional, as time permits)

### Simple Rules for Playing Marbles

**Ringer:** Two to six boys can play. A circle 5 to 10 feet in diameter is marked on the ground. Thirteen marbles are placed on a cross that is marked in the center of the ring. Two lines, each about 9 inches long, form the cross. One marble is placed at the center, and three are on each of the four parts of the cross. Each marble lies about 3 inches from the next. Each player uses a large marble, the shooter, to “shoot” the small marbles out of the ring. The player who shoots the most marbles out of the ring wins the game. (Many variations can be played.)

**Lagging:** Players start the first game by lagging for turns. They toss or shoot their shooters from a pitch line drawn outside the circle, with the middle of it touching the circle. On the opposite side of the circle, another similar line, the lag line, is drawn. The player whose shooter comes closest to the lag line plays first.

**Shooter Rules:** Your shooter cannot be smaller than  $\frac{1}{2}$  inch or bigger than  $\frac{3}{4}$  inch in diameter. A shooter may not be made of metal.

### Basic Terms for Marbles

- Bowling occurs when a player rolls a shot on the ground.
- Edgers are marbles near the edge of the ring.
- For Fair means playing for the fun of the game. At the end of each game, the marbles are returned to their owners.
- For Keeps means each player keeps the marbles that he shoots out of the ring.
- Hitting occurs when a player raises his hand from the ground while shooting.
- A Hit occurs when a player shoots a marble out of the ring.
- Hunching occurs when a player moves his hand forward across the ring line when shooting from the ring line, or when he moves his hand forward from the spot where the shooter came to rest inside the ring.
- Knuckling Down is a position in which at least one knuckle must touch the ground until the shooter has left the hand.
- Lofting (or Plunking) is a difficult shot that occurs when a shooter shoots in an arc in the air to hit a marble.
- Marbles are the target marbles only. They can be called mibs, miggs, ducks, kimmies, or hoodles.
- A Miss occurs when a player fails to knock a marble from the ring on a shot.
- Roundsters (or Circling) is the act of selecting the best location outside the ring for knuckling down.
- A Shooter is the attacking marble. It can also be called a taw, glassy, or monny.
- A Shot is the act of snapping the shooter at a marble by a quick extension of the thumb.



## CLOSING

- Remind Tigers that at the beginning of the meeting, they all said the Scout Oath. Ask them how the phrase “do my duty to God and my country” relates to today’s activities. (You can continue this through several meetings as a way to help them learn and understand what the Scout Oath is all about.)
- Review details for the Den Meeting 3 outing. Make sure all Tigers and their families know the plans.

## AFTER THE MEETING

- For refreshments, serve the trail food from earlier in the meeting.
- Clean up as needed.
- Record completion of requirements 3a, 3b, and 6.

## MEETING 2 RESOURCES

### ANIMAL PRINTS

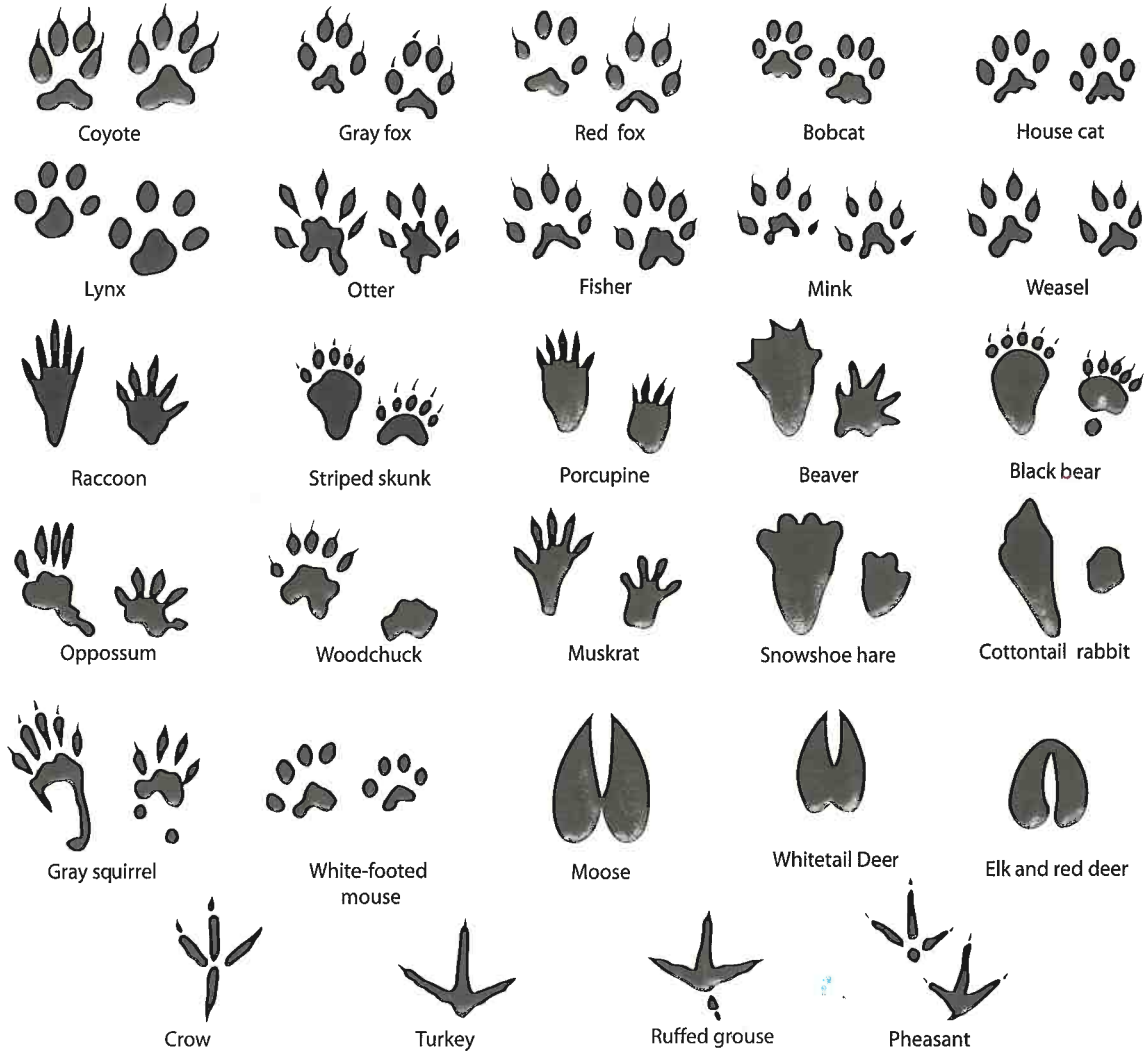

# MEETING 3 PLAN (Den Outing)

## NOTES TO DEN LEADER

Depending on your situation, it may be possible to complete the outing requirements 2, 3c, 4, 5, 6 & 7 in one field trip.

During this Tiger year, keep in mind that you will be introducing each boy and his parent/partner to the adventurous world of Scouting. We want this introduction to happen in the best possible way. If you had an event planned but the weather forecast is looking terrible, postpone the event for another day. You only get one chance for Scouting to make a first impression, so let it be a great one!

## PREPARATION AND MATERIALS NEEDED

- Prepare index cards for opening
- Paint chip cards—natural colors (greens, browns, tans, blues, whites, according to location), available from paint/hardware stores
- Coin for each Tiger
- Reference material for plant and animal identification from Meeting 2
- Cub Scout Six Essentials for each Tiger
- A trash bag and a box of nonlatex disposable gloves, in case the den comes across trash that can be picked up
- Unit den leader should have in possession (if required by local council practices) the tour and activity plan, signed activity consent forms, and a copy of the *Guide to Safe Scouting*.

## GATHERING

Depending on the tour plan, gather at a central location and carpool, or have the Tigers and partners meet at the location.

## OPENING

**Tiger #1 and Adult Partner:** As an American, I will do my best to be clean in my outdoor manners.

**Den Leader:** I will treat the outdoors as a heritage. I will take care of it for myself and others. I will keep my trash and garbage out of lakes, streams, fields, woods, and roadways.

**Tiger #2 and Adult Partner:** As an American, I will be careful with fire.

**Den Leader:** I will prevent wildfire. I will build my fires only when and where they are permitted and appropriate. When I have finished using fire, I will make sure it is cold-out. I will leave a clean fire ring or remove all evidence of my fire.

**Tiger #3 and Adult Partner:** As an American, I will be considerate in the outdoors.

**Den Leader:** I will treat public and private property with respect. I will follow the principles of Leave No Trace for all outdoor activities.

**Tiger #4 and Adult Partner:** As an American, I will be conservation-minded.

**Den Leader:** I will learn about and practice good conservation of soil, waters, forests, minerals, grasslands, wildlife, and energy. I will urge others to do the same.

**Tiger #5 and Adult Partner:** Let us think about these responsibilities as we stand and sing “America the Beautiful.”





*O beautiful for spacious skies,  
For amber waves of grain,  
For purple mountain majesties*



*Above the fruited plain!*

*America! America!*

*God shed his grace on thee*



*And crown thy good with brotherhood*

*From sea to shining sea!*

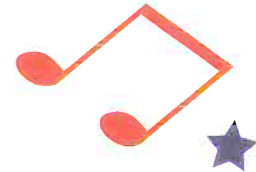

credit: Katherine Lee Bates, 1904

## TALK TIME

- Carry out business items for the den.

## ACTIVITIES

### ◆ Activity 1: Hike (Requirements 2, 3c, 4, and 7)

1. Go on a hike, and carry the Cub Scout Six Essentials. See the Tips for a Great Hike in the Meeting 3 Resources for helpful hiking hints.
2. Identify three plants, animals, or signs of animals according to location. Keep track so the Tigers can record their sightings in their *Tiger Handbook*.
3. Remind the boys that a Scout is obedient. It is important to listen to their den leader and adult partner when they are on the hike. They should not touch any plants unless told to because some plants can really hurt people.
4. Remind Scouts to think of ways they can show clean outdoor manners and be responsible for their trash as they hike. If you come upon trash, provide Tigers with nonlatex disposable gloves, and use the trash bag you brought along to clean up the trash. Be sure to pack out the trash and dispose of it in an appropriate location.

### ◆ Activity 2: Color Hunt

1. Stop along the trail, and give each pair a paint chip card. Instruct them to look around quietly and see how many of their colors they can match in the area.
2. Let them report briefly, then ask them to look around again and see how many different shades of green or brown they can see. Nature is a wonderful thing!

### ◆ Activity 3: Coin Activity

1. Distribute the coins (pennies and nickels work best), and give the Tigers a minute to look around and see how many loose items from nature they can find to put on their coin all at once.
2. Instruct them to observe without disturbing any living plant. Pick up only what has already fallen on the ground.
3. When the minute is over, let them report briefly. Remind them to take time to see the small things in the world as well as the big things that attract their attention easily.

## ◆ Activity 4: Outdoor Code and Leave No Trace

1. Ask Tigers to share ways that they demonstrated the Outdoor Code or the Leave No Trace Principles for Kids on their hike.
2. Have them complete requirement 3c by drawing a picture of what they did in their *Tiger Handbook*.

### CLOSING

- After the hike, remind the Scouts how nice the trail was (if it was), and tell them that's because many people before them took time and energy to save this trail for them! They can do their part to continue the practice by leaving what they found where it was, picking up anything that doesn't belong there, and leaving the area better than it was when they arrived!
- Ask Tigers to report on what plants or animals they observed during the hike that they had predicted they might see at the previous den meeting. Were they surprised by what they saw—or what they did not see? (requirement 7)

### AFTER THE MEETING

- Provide refreshments (trail food).
- Record completion of requirements 2, 3c, 4, and 7.

Upon completion of the Tigers in the Wild adventure, your Tigers will have earned the adventure loop shown here. Make sure they are recognized for their completion by presenting the adventure loops, to be worn on their belts, as soon as possible according to your pack's tradition.



## MEETING 3 RESOURCES

### TIPS FOR A GREAT HIKE

- Practice a “Buddy Check” while on the hike to impress all of its importance.
- Designate a “lead” hiker and a “trail” or “sweep” hiker. No one passes the lead or falls behind the sweep. These hikers should be able to contact each other, either with radios or by passing a message up the trail. Take care that no one gets separated.
- The lead hiker should set a pace that all can maintain. One way to do this is to have the slowest of your group lead the way.
- When it's time for a break, make sure everyone gets a rest—not just the front of the line.
- Scouts will forget to look at scenery, so stop the group and point out natural features, animal signs, interesting plants, and other sights.
- Make sure Scouts keep a good spacing from the hikers in front of them. There should be enough room to fall over without hitting anyone in front or back for all hikers. Help Scouts overcome the natural inclination to pack together on the trail.
- Bring a zippered bag with 1 cup of plaster of paris inside. If you find any animal tracks along the trail, mix some drinking water into the plaster and pour the mix into the tracks.



# NOTES



# CURIOSITY, INTRIGUE, AND MAGICAL MYSTERIES



## RATIONALE FOR ADVENTURE

This adventure helps Tigers explore how things work. Tigers and their adult partners will learn about cracking codes and solving mysteries, as well as discover how science helps us solve problems and understand why things work in certain ways.

## TAKEAWAYS FOR CUB SCOUTS

- Cooperating with others
- Completing simple tasks
- Practicing listening
- Practicing communicating
- Practicing teamwork in games
- A Scout is helpful, friendly. 

*Tiger Handbook, page 108*

## ADVENTURE REQUIREMENTS

1. Learn a magic trick. Practice your magic trick so you can perform it in front of an audience.
2. Create an invitation to a magic show.
3. With your den or with your family, put on a magic show for an audience.
4. Create a secret code.
5. With the other Scouts in your den or with your family, crack a code that you did not create.
6. Spell your name using sign language, and spell your name in Braille.
7. With the help of your adult partner, conduct a science demonstration that shows how magic works.
8. Share what you learned from your science demonstration.

### NOTES TO DEN LEADER

Meeting 3 will be a magic show for Tigers to perform the tricks they have learned and practiced during this adventure. Tigers will prepare invitations during Meeting 1, so the details of the magic show should be in place by that time (date, time, location, etc.). During Meeting 2, find out the number of attendees expected, as well as any audience members' special needs, in order to plan for seating and refreshments. The magic show may take place in the home of a den member (with additional siblings and family members for an audience), at your regular meeting place, or with any audience that would enjoy viewing a Cub Scout magic show.

See the Appendix for optional den meeting activities, including openings, gatherings, and closings.

# MEETING 1 PLAN

## PREPARATION AND MATERIALS NEEDED

- U.S. and den flags
- Items for selected magic tricks: Choose the magic trick you would like to teach your den, and be sure you gather the appropriate materials.
- *Cub Scout Magic* book for reference or a book from the library about magic tricks for children
- Samples of secret codes, paper, pencils (See Meeting 1 Resources for examples of codes.)
- Read the Curiosity, Intrigue, and Magical Mysteries adventure in the *Tiger Handbook*.

## GATHERING

Provide Tigers with samples of secret codes, and have them practice writing codes. Then get each member of the den to decipher a message that he didn't help create, as in requirements 4 and 5.

## OPENING

- Conduct a flag ceremony of your choosing that includes the Pledge of Allegiance and, as appropriate, the Scout Oath and Scout Law.

## TALK TIME

- Carry out business items for the den.
- Have the Tigers share what they have been doing since the last meeting. Has any one of them participated in an activity that might seem “mysterious” to others? Talk about the fact that magic usually consists of a distraction or an illusion—tricking the minds of the audience members into seeing things the way you intend. Science helps us understand why things work the way they do.

### NOTE TO DEN LEADER

Share with adult partners that, depending on their Tiger's skill level, he may need additional support in composing, coding, and decoding secret messages. Keep in mind that the performance standard for Cub Scouts is that they do their best, and that they may do so with help. The messages they send may be as simple as the Cub Scout motto, “Do Your Best.”

## ACTIVITIES

### ◆ Activity 1: Learn a Magic Trick (Requirement 1)

The *Tiger Handbook* has one example of a trick Tigers can try, and you can also refer to *Cub Scout Magic* for ideas.

Another trick you might choose to teach Tigers is the Freezing Water Trick. In this trick, Tigers will pour water into a mug; when the mug is turned upside down, the water will have magically turned into an ice cube.

Prepare for the trick by doing the following:

1. Gather several mugs, sponges, ice cubes, scissors, and water.
2. Cut the sponges to snugly fill the bottoms of the mugs.
3. Place an ice cube in each mug.

Then, when the audience is watching, the Tiger announces that he will magically freeze water. He pours a small amount of water into the mug and covers it with a cloth. After saying the magic words, he carefully turns the mug over without showing the inside to the audience, and the ice cube will fall out on the table.

Practice the trick in advance to discover the amount of water the sponge will absorb, and encourage Tigers to add fun and excitement to their presentation.

Have Tigers practice their tricks so they will be able to perform them in front of an audience. Remind Tigers to demonstrate showmanship by using magicians' words like "hocus pocus," "abracadabra," "shazam," and "presto" to enhance their tricks. Props such as a magic wand or top hat can also encourage showmanship.

### ◆ **Activity 2: Codes (Requirements 4, 5, and 6) (See Meeting 1 Resources for code charts)**

1. Guide Tigers in creating their own codes using symbols, shapes, or numbers to represent letters.
2. Next have the boys write messages using their codes and ask other members of the den to try to decipher them.
3. Each Tiger should also decipher a code created by another member of the den.
4. Show Tigers the American Sign Language alphabet in their handbooks. Help them learn to sign their names using ASL.

### ◆ **Activity 3: Create Invitations (Requirement 2)**

1. Make and decorate invitations for the Tigers' families to attend the den magic show.
2. Confirm the details of the performance time and location with each Tiger.

## **CLOSING**

Discuss the ways that perfecting a magic trick or deciphering another person's secret message can sometimes be frustrating. Which points of the Scout Law will be the focus of this adventure? Congratulate the Tigers on a job well done.

## **AFTER THE MEETING**

- Work together to clean up the meeting place.
- Serve refreshments, if desired.
- Record completion of requirements 1, 2, 4, 5, and 6.





















# MEETING 1 RESOURCES

## ACTIVITY 2

### ◆ Secret Code Language

There are several examples of codes here.

**Code 1:** Code 1 can be created using a set of simple word processing symbols to represent letters.

A	B	C	D	E	F
□	⊗	⌘	◆	●	★
G	H	I	J	K	L
					
M	N	O	P	Q	R
					
S	T	U	V	W	X
					
Y	Z				
					

**Code 2:** Code 2 uses the standard alphabet but makes letter substitutions.

A	B	C	D	E	F
Z	A	B	C	D	E
G	H	I	J	K	L
F	G	H	I	J	K
M	N	O	P	Q	R
L	M	N	O	P	Q
S	T	U	V	W	X
R	S	T	U	V	W
Y	Z				
X	Y				



**Code 3:** Code 3 has spaces for a Cub Scout to insert symbols to create his own code.

A	B	C	D	E	F
G	H	I	J	K	L
M	N	O	P	Q	R
S	T	U	V	W	X
Y	Z				

**American Sign Language**

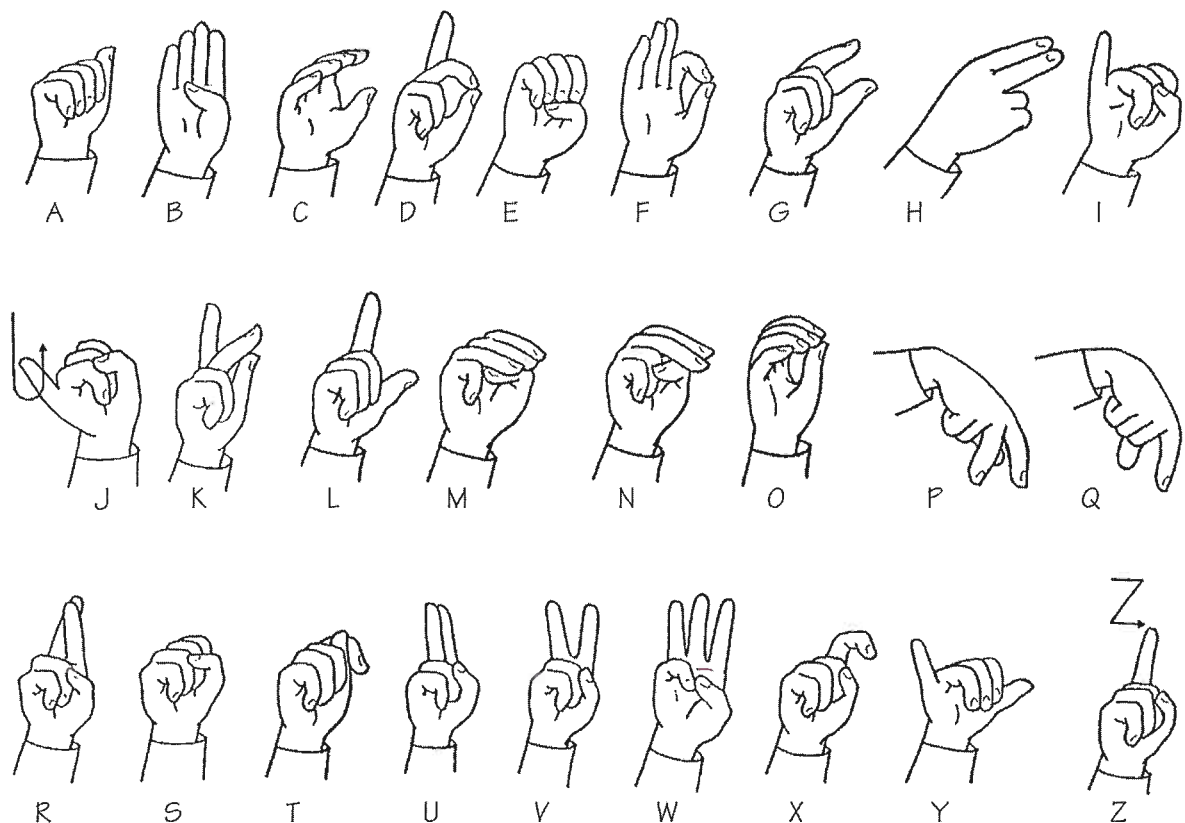

# MEETING 2 PLAN

## PREPARATION AND MATERIALS NEEDED

- U.S. and den flags
- Gathering: poster paper or card stock for writing in Braille; items for spelling out names (e.g., buttons, split peas); glue
- Items for science investigations (will vary depending on investigations chosen)
- Assemble “genius kits” before the meeting. (See Meeting 2 Resources for examples of materials.)

## GATHERING

Have Scouts use the materials provided (such as split peas) to try spelling their names in Braille.

## OPENING

- Conduct a flag ceremony of your choosing that includes the Pledge of Allegiance and, as appropriate, the Scout Oath and Scout Law.

## TALK TIME

- Carry out business items for the den. Have Tigers show their names they made during the Gathering. Review the information in their handbooks about Braille (requirement 6).

## ACTIVITIES

### ◆ Activity 1: Science Investigation (Requirement 7)

1. Discuss with the den the science investigation you've chosen for them to conduct. Have each Tiger and his adult partner write down what they think the result will be. (See Meeting 2 Resources for investigation ideas.)
2. Conduct the science investigation with your den.
3. Compare notes on the outcome of the investigation. How many were right in their predictions? How many guessed incorrectly?

### ◆ Activity 2

- Provide “genius kits” for each Tiger and his partner, and let them create something from the items provided. It is helpful to provide the boys with a simple task to complete using the materials in the kit. That task might be to create a work of art or a toy, such as a car.
- You may adapt the materials in the kit to ensure they are inexpensive and will provide Cub Scouts with what they need to complete their tasks. (See Meeting 2 Resources for sample items that could be put in the kits.)
- Be sure to make each kit identical so all Tigers will start out with the same materials. At least some part of each item in the kit must be used in some way.

### ◆ Activity 3

Decide which magic tricks will be performed at the pack meeting, and practice. If the den is large, it may be necessary to select three or four tricks and have groups of boys work together so that everyone can perform.

## CLOSING: WHAT DID YOU LEARN?

Here are some simple questions for parents to ask that can help boys reflect and grow from this activity:

- What happened during your science investigation?
- Was there anything mysterious?
- Was there something in the investigation that you're curious to learn more about?

Make sure all Tigers and their families know the plans for the den magic show in Meeting 3.

## AFTER THE MEETING

- Make sure everyone helps to clean up the meeting place.
- Serve refreshments, if desired.
- Record completion of requirement 7.

# MEETING 2 RESOURCES

## Gathering: Braille Alphabet



# ALPHABET

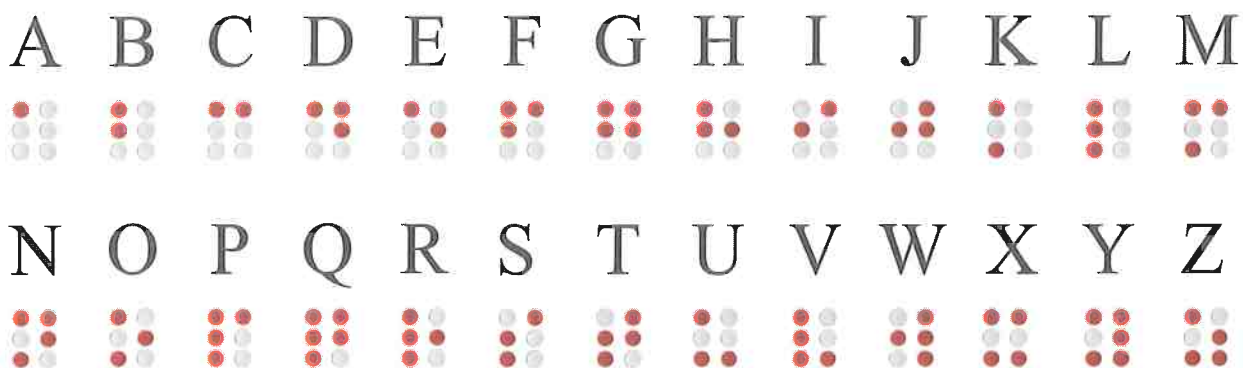

The Signs, Signals, and Codes Merit Badge Braille Supplement (No. 621366) includes a Braille alphabet in raised dots and several phrases in Braille that Cub Scouts could use to practice. Contact your local council Scout shop for more information about this resource.

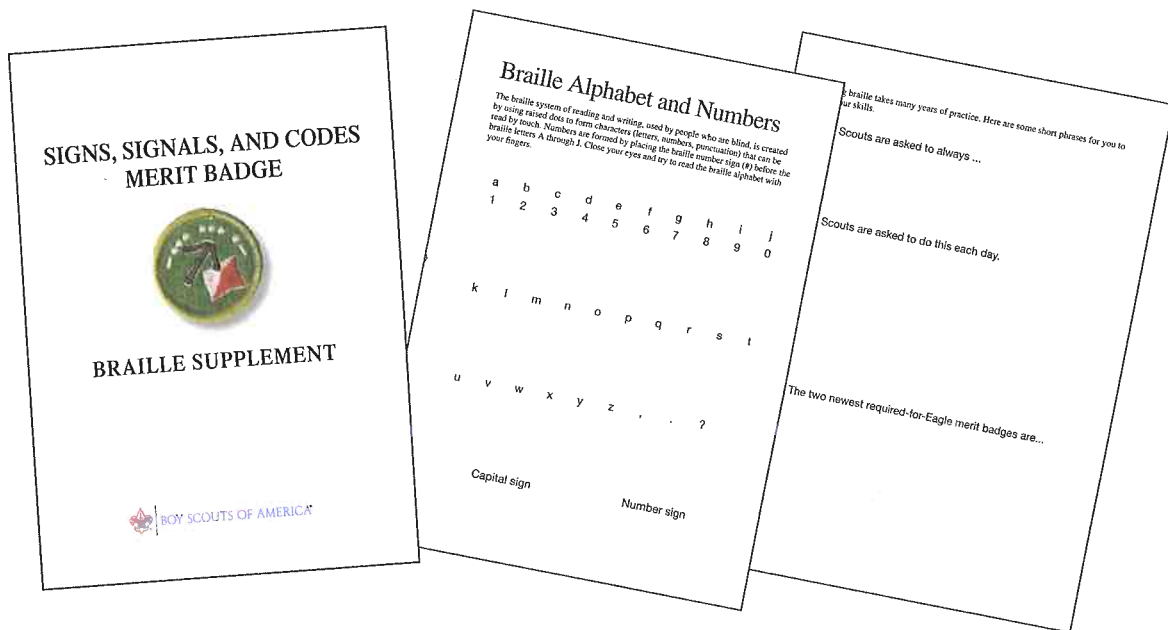

## ◆ Activity 1: Sample Science Investigations

**Celery Stalk:** Provide each Tiger and his adult partner with a stalk of celery (including leaves) and two paper cups filled halfway with water. Have them add 20 drops of food coloring to the water, using a different color for each cup. Ask each boy to bite off the end of his celery stalk. His adult partner should then slice the stalk with a knife, about halfway up from the wide bottom but leaving the top of the stalk intact. Push the two cups together and put each leg of the stalk into a different color of water. Set the celery aside until the end of the meeting, and record what happens. If possible, continue to observe the celery during the next day or two, and record additional changes.



**Bending Light Rays:** First, shine a flashlight against a wall and note the direction the beam of light goes in when it hits the surface. Then shine the flashlight into a mirror at an angle. Note what happens. Now see if you can make the light shine from the flashlight into a mirror, and from there into another mirror at an angle.

**Color Magic:** Each Tiger will need a black marker (not permanent), a white paper coffee filter, water, and a clear plastic cup. Have each Tiger cut a circle about as big as his hand out of the filter. Draw a line across the middle of the circle. Put some water in the cup—enough to cover the bottom. Curl the paper slightly so it fits inside the cup, making sure the bottom it is in the water. Ask Tigers what they think will happen. Watch as the water flows up the paper. Record what you see.

**Spoon on the Nose:** Provide each Tiger with a metal spoon—the lighter the spoon, the better. Rub your thumb into the bowl of the spoon. This releases oils from your skin onto the spoon. Next, breathe on the spoon to create fog. Holding the spoon high on the handle, cover the tip of your nose gently with the bowl of the spoon. (Do not press hard.) Now slide the spoon lightly and gently until the tip of the spoon is on the tip of your nose, and let go. Record your results.

**Mobius Strip:** Take a long, fairly wide strip of paper. Twist the paper once and tape it into a loop. Snip the loop up the center. When you're done cutting, you'll have one big loop.

## ◆ Activity 2: Sample Genius Kit Items (Items in kits may vary.)

Quantity	Item	Quantity	Item
2	toilet paper rolls	1	strip of mailing labels
4	cotton swabs	2	plastic milk or juice caps
3	small squares of construction paper	1	straw
2	binder clips	3	chenille stems
1	paper plate	1	spool
1	empty CD case	4	craft sticks
4	pieces of yarn or string		

# MEETING 3 PLAN

## PREPARATION AND MATERIALS NEEDED

- U.S. and den flags
- Chairs for magic show audience
- Items for each magic trick being performed
- Refreshments to be served after the performance
- A display of science investigations for the audience members to view

## GATHERING (REQUIREMENT 8)

Prepare a display of the science investigations from the previous meeting to show the guests.

## OPENING

- Say the Pledge of Allegiance and, as appropriate, the Scout Oath and Scout Law. If the den does not have a United States flag on the outing, ask one Scout to display the flag on his uniform for the group.

## TALK TIME

- Carry out business items for the den.

## ACTIVITIES

### ◆ Activity 1: Magic Show (Requirement 3)

1. Conduct the magic show as rehearsed.
2. Share refreshments with the audience.
3. Thank everyone for attending.

## CLOSING

- Congratulate the Tigers on their show, and note positive moments you observed.

## AFTER THE OUTING

- Ensure cleanup takes place.
- Send thank-you notes to those who helped.
- Record completion of requirements 3 and 8.

Upon completion of the Curiosity, Intrigue, and Magical Mysteries adventure, your Tigers will have earned the adventure loop shown here. Make sure they are recognized for their completion by presenting the adventure loops, to be worn on their belts, as soon as possible according to your pack's tradition.



# NOTES



# EARNING YOUR STRIPES



## RATIONALE FOR ADVENTURE

In this adventure, Tigers will learn about what it means to wear Tiger orange. The color orange represents warmth, cheer, enthusiasm, creativity, and energy. Tigers are proud to wear the color orange; they like to show their enthusiasm by helping others and by using their energy to complete tasks. Helping others provides the opportunity to build self-esteem, give goodwill, and create a cheerful attitude. The warmth in the color orange is shared by using proper manners when speaking to others.

## TAKEAWAYS FOR CUB SCOUTS

- Learning what it means to be helpful and courteous
- Providing service to others
- Assuming responsibility
- Cooperating with others
- Developing a positive attitude toward people in need of help
- Increasing self-esteem
- Practicing good manners
- A Scout is loyal 

*Tiger Handbook, page 124*

## ADVENTURE REQUIREMENTS

1. Bring in and share with your den five items that are the color orange.
2. Demonstrate loyalty over the next week at school or in your community. Share at your next den meeting how you were loyal to others.
3. With your adult partner, decide on one new task you can do to help your family, and do it.
4. Talk with your den and adult partner about polite language. Learn how to shake hands properly and introduce yourself.
5. Play a game with your den. Then discuss how your den played politely.
6. With your adult partner and den, work on a service project for your pack's meeting place or chartered organization.

### NOTES TO DEN LEADER

Tigers will need to collect five orange items at home to share during Meeting 2. During Meeting 1, Tigers will choose a service project for their pack's meeting place or chartered organization.

Meeting 3 will be a den outing to perform the service project. In advance of the outing, the leader will need to make arrangements with the outing location and confirm the outing plan with families, including transportation and any additional items they need to bring. Make sure a tour and activity plan has been submitted, if required, and activity consent forms are distributed, signed, and collected.

See the Appendix for optional den meeting activities, including openings, gatherings, and closings.

# MEETING 1 PLAN

## PREPARATION AND MATERIALS NEEDED

- U.S. and den flags
- Gallon milk jugs cut in the shape of scoops for the toss game
- Game pieces for activity game
- Paper plates and plastic tableware for mock party
- Blindfolds
- Read the Earning Your Stripes adventure in the *Tiger Handbook*.

## GATHERING

Have the Tigers play Milk Jug Toss with their adult partners. To increase the degree of difficulty, widen the distance between the catcher and thrower or switch to tossing a different item (e.g., bean bag, Wiffle ball, pingpong ball, rolled-up sock). To prepare the milk jugs for the game, cut the bottom half off, leaving the handle in place to form a scoop.



## OPENING

- Conduct a flag ceremony of your choosing that includes the Pledge of Allegiance and, as appropriate, the Scout Oath and Scout Law.
- Have all Tigers form a circle around the U.S. flag, and recite the Pledge of Allegiance. Ask the boys why we say this pledge; in their answers, look for the idea of loyalty to our country. Challenge each Tiger to do his best in the following week to show loyalty at school or in his community. Ask all of them to report back at the next meeting (requirement 2).

## TALK TIME (REQUIREMENT 4)

- Carry out business items for the den.
- Introduce the topic of manners and polite language for the adventure. Being friendly, courteous, and kind involves using polite language. Examples of using polite language include saying “please,” “thank you,” “you’re welcome,” “excuse me,” and using titles of “sir” and “ma’am” when addressing adults. To illustrate polite language, tell Tigers to guess the right response in the following situations. Create enough scenarios so that each boy has a chance to participate.
  - Someone buys an ice cream bar for you.
  - You need help completing your homework.
  - A new boy is now in your class at school.
  - An adult gives you a task to complete.
- Introduce the concept of service projects and why we do them. Have the Scouts brainstorm some ideas for a service project for this month’s adventure as preparation for requirement 6. If possible, choose a project that promotes the adventure topic—being helpful and using good manners and polite language. Some examples for projects include:
  - Bake and decorate cookies, and deliver them to the local police or fire station as thanks for serving your community.
  - Bring toys, books, or coats from home to donate to a children’s hospital or child care center.
  - Conduct a cleanup in your meeting place area.
  - Weed or plant flowers in a flower bed at your chartered organization’s facility.



## ACTIVITIES

### ◆ Activity 1: Game Playing (Requirement 5)

- Play a game such as tic-tac-toe or checkers.
- Practice congratulating your opponent whether you win or lose.
- Discuss how your den played politely.

### ◆ Activity 2: Manners Role-Play

- Set up a mock party, and role-play situations for Tigers to practice manners.
- Make a set of instruction cards. (See Meeting 1 Resources for sample cards.)
- Play some fun music, and have Tigers and adult partners mill about the “party.” After a brief time, the leader stops the music. Have each boy, in turn, draw a card and respond or act out their card appropriately for the scenario.

## CLOSING

From the Scout Law, identify which points relate to the topic of being helpful and using good manners and polite language.



### Do-at-Home Project Reminder:

Each Tiger should go on a scavenger hunt at home and choose five orange items to bring to the next meeting and share with the den. Tigers should also work to show loyalty at school or in their community during the next week.

## AFTER THE MEETING

- Make sure everything is cleaned up.
- Serve refreshments, if desired.
- Record completion of requirements 4 and 5.

# MEETING 1 RESOURCES

## Manners Role-Play Cards

You would like to talk with an adult who is speaking with another adult.	Someone thanks you for holding the door open.
You meet a friend of your parent or guardian for the first time.	An adult (who is a woman) asks if you are having a nice time.
Someone gives you a nice compliment.	You accidentally bump into someone as you cross the room.
An adult (who is a man) asks if you have a pet fish.	You would like to take a snack from a table of food, but two people are standing in your way.

## MEETING 2 PLAN

### PREPARATION AND MATERIALS NEEDED

- U.S. and den flags
- *Tiger Handbook*
- Prepare materials for the obstacle course in Activity 3.

### GATHERING

Have Tigers display their orange items in the meeting space. Ask them to walk around to see other Tigers' items and think of one friendly question they would like to ask about something they see.

### OPENING

- Conduct a flag ceremony of your choosing that includes the Pledge of Allegiance and, as appropriate, the Scout Oath and Scout Law.

### TALK TIME

- Carry out business items for the den.
- Have Tigers share what they did during the last week to show loyalty at school or in the community. Encourage them to make connections to the Scout Law and tell how it felt to support the people and groups that are important to them (requirement 2).

## ACTIVITIES

### ◆ Activity 1: Orange Scavenger Hunt Sharing (Requirement 1)

- Have Scouts take turns sharing the orange items they brought from home.
- As the items are shared, give Tigers the opportunity to ask a friendly question to a fellow Tiger about an item he brought.

### ◆ Activity 2: A New Way to Help (Requirement 3)

- Have each Tiger and his adult partner decide upon a new task that each Tiger can do.
- Have each Tiger decide when to do it with his family and ask them to share this at the next den meeting.

### ◆ Activity 3: Earning Your Stripes Obstacle Course Game

1. Set up an obstacle course as appropriate for your meeting space. Include stages such as crawling through a box, running through tires, spinning a hula hoop, or jumping rope. Have fun creating obstacles using simple items from home.
2. Congratulate each Tiger as he completes the course. If appropriate, invite siblings to also participate.
3. Encourage Tigers to be helpful to others as they play the game. Tell everyone to use polite language!
4. If possible, allow each Tiger, or other family members, to improve their time by completing the obstacle course more than once.
5. Another option is to find another game to play together with family members.

## CLOSING

- Review details for the Meeting 3 den outing and service project. Make sure all Tigers and their families know the plans.

## AFTER THE MEETING

- Record completion of requirements 1 and 2.
- Work together to clean up the meeting place.
- Serve refreshments, if desired.
- Prepare thank-you notes for the Tigers to sign at the next meeting.

# MEETING 3 PLAN (Den Outing)

## PREPARATION AND MATERIALS NEEDED

- Materials will vary, depending on the service project chosen.
- Unit den leader should have in possession (if required by local council practices) the tour and activity plan, signed activity consent forms, and a copy of the *Guide to Safe Scouting*.

## GATHERING

Review the manners expected while on the outing.

## OPENING

- Say the Pledge of Allegiance and, as appropriate, the Scout Oath and Scout Law. If the den does not have a United States flag on the outing, ask one Scout to display the flag on his uniform for the group.
- Recite the Scout Law. Ask boys to explain how they will be helpful while working on the service project.

## TALK TIME

- Carry out business items for the den.
- Have Tigers share the tasks they completed to help their families.
  - What did you enjoy the most about doing the new task with your family?
  - If you do it again, will you do it the same way or do something different?
  - What did you learn about being helpful as you did the new task with your family?
  - Why do you think it is important to remember to be polite with your family members?
- Remind Scouts that they will be showing loyalty to their community through their service project. Discuss ways that their work will benefit the community.

## ACTIVITIES

### ◆ Activity 1: Service Project (Requirement 6)

1. Carry out the service project as planned.
2. Involve all Tigers and their partners during the project.

### ◆ Activity 2: Den Yell (Requirement 2)

1. If there is an appropriate moment during the project, have Tigers come together to share additional ways they were loyal during the past week. Tigers who did not get to share during the previous meeting can share at this time.
2. Have the den create a den yell to show team spirit and loyalty to their den.

### Sample Den Yells

**Den One, Den One,  
We're good Scouts,  
We're having fun.**

**I don't know but I've been told,  
Tiger Scouts wear blue and gold.  
Listen up, hear what we say,  
Tiger Scouts will lead the way.**

## CLOSING

Form a circle. Teach and recite with Tigers the closing prayer, "May the Great Master of all Scouts be with us until we meet again, and may we follow the path that leads to him."

## AFTER THE MEETING

- Serve refreshments, if desired.
- Record completion of requirements 2, 3, and 6.
- Make sure all supplies have been cleaned up from the work site.
- Prepare thank-you notes for those who helped with the project.

Upon completion of the Earning Your Stripes adventure, your Tigers will have earned the adventure loop shown here. Make sure they are recognized for their completion by presenting the adventure loops, to be worn on their belts, as soon as possible according to your pack's tradition.





# FAMILY STORIES



## RATIONALE FOR ADVENTURE

This adventure will help Tigers learn about their families and their heritage.

## TAKEAWAYS FOR CUB SCOUTS

- Appreciating diversity and each Scout's unique family heritage
- Developing confidence, and encouraging bravery and patience
- Being observant
- A Scout is courteous.



*Tiger Handbook, page 134*

## ADVENTURE REQUIREMENTS

1. Discuss with your adult partner and/or family where your family originated. Discuss their history, traditions, and culture—your family heritage. Share a story or bring something to share with your den about yourself and your family.
2. Make a family crest.
3. Visit your public library to find out information about your heritage.
4. Interview one of your grandparents or another family elder, and share with your den what you found.
5. Make a family tree.
6. Share with your den how you got your name or what your name means.
7. Share with your den your favorite snack or dessert that reflects your cultural heritage.
8. Learn where your family came from, and locate it on a map. Share this information with your den. With the help of your adult partner, locate and write to a pen pal from that location.

### NOTES TO DEN LEADER

Remember to be sensitive to the ways that all families are different. Leaders should encourage Scouts to find ways they can celebrate their families in positive ways that fit their unique situations.

Prior to the first meeting, have each Tiger and his adult partner make a family crest and a family tree at home to bring to the meeting and share. Also ask the Tiger to find out how he got his name and/or his name's meaning and to share what he learns at the first den meeting. (See the Do-at-Home Project under Meeting 1 Resources.)

Meeting 2 is a den outing to a local library to research family history. In advance of the outing, the leader will need to make arrangements with the library or outing location and confirm the outing plan with families, including transportation and any additional items they need to bring. Let the library know how many adults and youth will be coming and what it is you are hoping to get out of the visit. Ask the librarian if they will be able to show the boys how and where to get information. Make sure a tour and activity plan has been submitted, if required, and activity consent forms are distributed, signed, and collected.

Meeting 3 will be an International Food Picnic for families. Encourage families to begin planning ahead for the foods and other items or games they will contribute. Be sure that all other needs for the meeting location are in place in advance. Consider checking with your pack to see if more dens would like to participate in the picnic. Work with your Cubmaster and other leaders and parents to organize this event.

For requirement 8 (correspondence with a pen pal), please ask adult partners to assist their Tigers. The pen pal may be a family member who lives in the location of the family's origin. Another option might be to find a Scouting group in that location and correspond with them. Many national Scouting organizations from around the world help to connect Scouting pen pals with one another.

See the Appendix for optional den meeting activities, including openings, gatherings, and closings.

# MEETING 1 PLAN

## PREPARATION AND MATERIALS NEEDED

- U.S. and den flags
- Copy of Scout Oath and Scout Law
- Assorted board games, checkers, playing cards for Gathering activities
- Map of the world to show where families originated
- Pictures of families, foods, and clothing that display different cultures
- Cards with the word “hello” written in four or five different languages
- Copy of “A Positive Attitude About Culture” found in the Meeting 1 Resources, to be given out at the beginning of the meeting
- Camera and printer to take pictures of the boys and print them; or paper and crayons to be used for self-portraits of each Tiger
- Large piece of paper to make a den family tree
- Read the Family Stories adventure in the *Tiger Handbook*.

## GATHERING

- Take a picture of each of the boys so that you can print it to be put on the den family tree.
- Put out playing cards or a few board games, such as checkers, mancala, Chinese checkers, or any other simple board game. Invite Tigers and adult partners to participate in one of the games. The activity is for Tigers and adult partners to be involved together.

## OPENING

- Conduct a flag ceremony of your choosing that includes the Pledge of Allegiance and, as appropriate, the Scout Oath and Scout Law.
- Optional Opening:
  - Ask the Tigers to stand with their adult partners. Have each group or family take part in the opening by leading one part of it. Here are suggested parts:
    - Call for Scout salute and lead the Pledge of Allegiance.
    - Lead the Scout Oath.
    - Lead the Scout Law.
    - Lead the group in a prayer.
    - Sing a patriotic song.
    - Lead the den cheer.

## TALK TIME

- Carry out business items for the den.
- Thank each family for participating in the opening of the den meeting.
- Introduce the Family Stories adventure by talking briefly about what makes up a family.
- Allow Tigers to share how they got their names or their meanings (requirement 6).

## ACTIVITIES

### ◆ Activity 1: Family Heritage (Requirements 1 and 6)

1. Teach the Tigers how to say “hello” in different languages. This will be a good start to the family heritage concept of this elective.

Language	Hello
Danish	Hej
French	Bonjour
German	Guten Tag
Hawaiian	Aloha
Italian	Buongiorno
Portuguese	Olá
Norwegian	Hei
Spanish	Hola
Vietnamese	Chào
Arabic	Ahlan
Hindi	Namaste
Chinese	Ni hao

2. Give each Tiger and his partner an opportunity to tell about their family. Have a map of the world and ask each Tiger if he knows where his family originated. Mark it or put their photo on the map.
3. Allow for discussion about the meaning of heritage. If possible, have something from your family to use as an example of your family's customs or traditions.

◆ **Activity 2: Different but Alike (Requirements 1 and 2)**

1. Tell how we are different but alike. Share a story or information from a children's book, magazine, or Internet source that helps illustrate or reinforce your discussion about different cultures and their similarities. Explain that while we are different, we need to respect those differences in each other.
2. Share the family crests that the Tigers created. Look for the similarities and differences in each crest.

◆ **Activity 3: Den Family Tree (Requirement 5)**

1. Create a den family tree using the pictures taken at the beginning of the meeting. If a camera and printer are not available, have each Tiger draw a self-portrait to put on the den family tree.
2. Consider displaying the den family tree at the pack meeting.
3. Have the Tigers also share their own family trees that they made with their partners.

**CLOSING**

- Spend a few moments reflecting on the information shared with the boys. Ask each Tiger to mention one new thing that he learned from this meeting.
- Go over the details for the outing to the library and plans for the picnic.
- Have Tigers come up with questions to ask at the library.



### Do-at-Home Project Reminder:

Remind Tigers that they will need to contact a pen pal from the country of their family's origin. This can occur at any time during the adventure, but Tigers should allow time for delays in correspondence (requirement 8).

Tigers will also need to interview a grandparent or another family elder to complete requirement 4.

## AFTER THE MEETING

- Serve refreshments, if desired.
- Record completion of requirements 1, 2, 5, and 6.
- Work together to clean up the meeting place.
- Have Tigers prepare a thank-you card for their outing if someone will be showing them around the library.
- Begin the conversation about hosting an International Food Picnic. (See Meeting 2 Plan.)

## MEETING 1 RESOURCES



### A POSITIVE ATTITUDE ABOUT CULTURE

Positive, flexible attitudes toward other people are rooted in strong, positive images of ourselves. Self-assured children are not threatened by differences. They remain open to the new experiences that differences make possible. Self-confident children learn to be skeptical of negative cultural myths about other people. They make up their own minds about people as individuals rather than as members of a stereotyped category.

Encourage and help your child to find out about his family history. You will have the opportunity to be part of his adventure as he explores his roots and his heritage. You can help him find family pictures, record family stories told by relatives, review county archives or newspaper files, and visit libraries or cemeteries where family history information might be found. Help him organize his family story. Guide him when he has questions about the customs or traditions of other cultures he encounters in his den or classroom. Help him prepare his family story for exhibit at the pack heritages celebration.

Enjoy the time you spend together. Seeing your family heritage through your child's eyes can be among the most satisfying things you'll do.





## DO-AT-HOME PROJECT: FAMILY CREST AND TREE (REQUIREMENTS 2 AND 5)

Before the first meeting of the Family Stories adventure, Tigers will work with their adult partners to learn more about their families. Look in the *Tiger Handbook* to help you get started. You may use the crest template shown here and the tree template in the handbook, or you may use separate pages and create your own.

### Family Crest

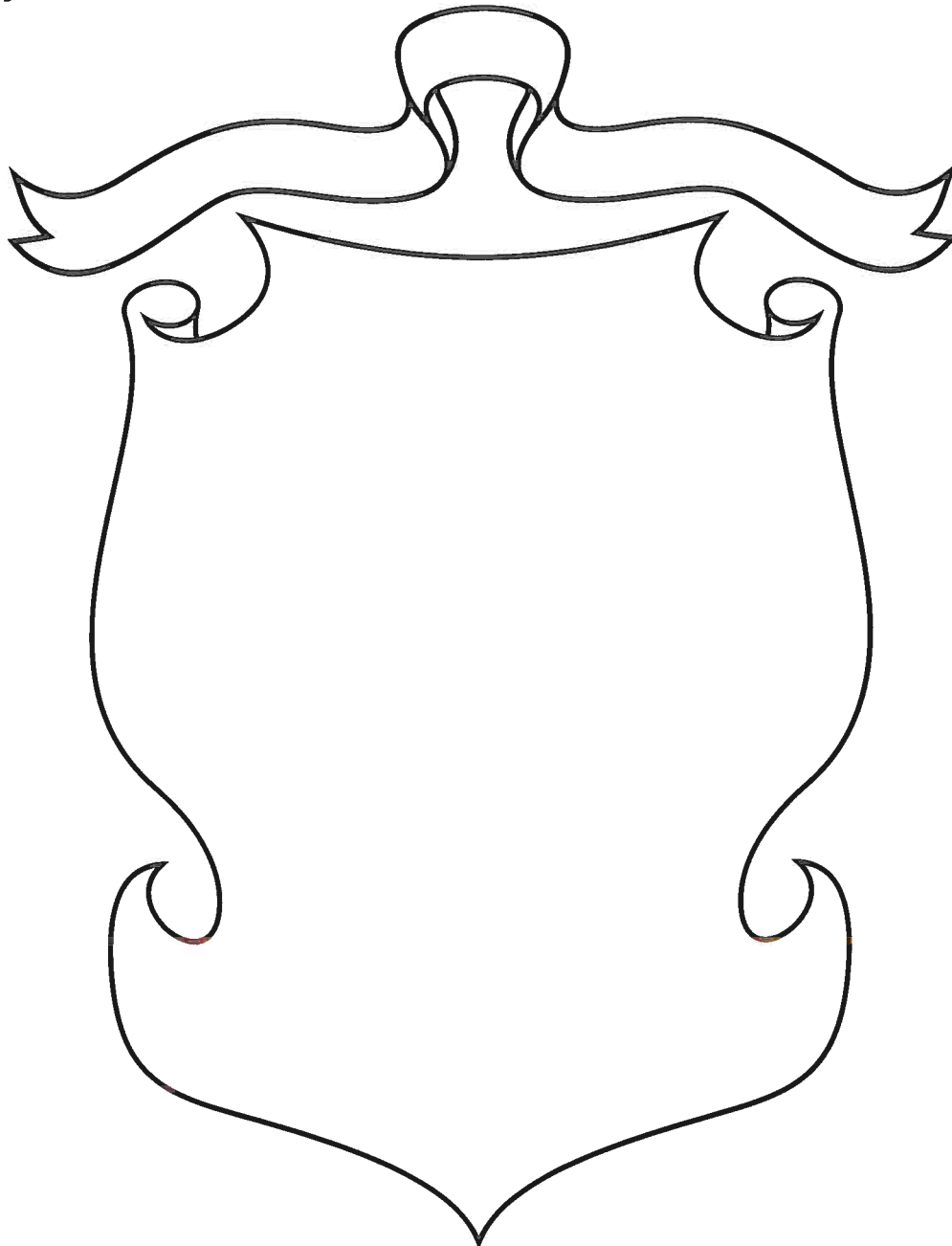

# MEETING 2 PLAN (Den Outing)

## PREPARATION AND MATERIALS NEEDED

- Contact the library ahead of time to make arrangements. Let them know how many adults and youth will be coming and what it is you are hoping to get out of the visit. Ask if there will be any hands-on opportunities for the boys. Can the Tigers get a library card if they don't have one? Ask the librarian if they will be able to show the boys how and where to get information.
- Unit den leader should have in possession (if required by local council practices) the tour and activity plan, signed activity consent forms, and a copy of the *Guide to Safe Scouting*.
- Make copies of the International Food Picnic form in Meeting 2 Resources.

## GATHERING

The outing to the library will be a good opportunity to teach the boys where and how they can get information. Explain to the boys what is expected of them. They need to be quiet and on their best behavior. Remind them of the list of questions they want to ask. Use the buddy system.

## OPENING

- Say the Pledge of Allegiance and, as appropriate, the Scout Oath and Scout Law. If the den does not have a United States flag on the outing, ask one Scout to display the flag on his uniform for the group.

## TALK TIME

- Carry out business items for the den.

## ACTIVITIES

### ◆ Activity 1: Library Visit (Requirement 3)

1. Visit a library to find out about each Tiger's family heritage and how he can locate more information. Learn about customs, foods, games, languages, etc.
2. With the assistance of the librarian, the adult partners will help guide the boys to books at their age level.
3. Have the Tigers and their adult partners fill out the International Food Picnic form as they research their heritage.
4. If there is time, have the Tigers and their adult partners share what they will bring to the picnic.

### ◆ Activity 2: Thank You

Thank those who were in charge of the visit. Plan a cheer ahead of time to give to them (be sure you have prior approval since you will be in a library). Give them the thank-you card that was prepared at Meeting 1. If time allows and there is an area to do so, gather the boys to talk about what they learned and how they feel about the visit.

## CLOSING

- Complete preparations for the international picnic (Meeting 3). Ask families to share what they will bring.
- Remind Tigers that they need to interview a family elder before the next meeting.



### Do-at-Home Project Reminder:

In preparation for the International Food Picnic in Meeting 3, Tigers will need to prepare a food that represents their family's heritage. See the flier in Meeting 2 Resources.

## AFTER THE MEETING

- Record completion of requirement 3.
- Provide refreshments if allowed.

# MEETING 2 RESOURCES

## Meeting 2: International Food Picnic



**Date:** \_\_\_\_\_

**Time:** \_\_\_\_\_

**Food I will bring:**

\_\_\_\_\_

\_\_\_\_\_

\_\_\_\_\_

**This food comes from:**

\_\_\_\_\_

\_\_\_\_\_

\_\_\_\_\_

**Family members who will come:**

\_\_\_\_\_

\_\_\_\_\_

\_\_\_\_\_

**Other items needed:**

\_\_\_\_\_

\_\_\_\_\_

\_\_\_\_\_

### NOTE TO ADULT PARTNERS

It will be fun for Tigers to share food and games from different cultures with fellow Tigers and their adult partners. Help the boys select food that is different but nutritious, making healthy choices. The games they play can be games they were able to look up through the Internet (with a parent's or guardian's help) or games they learned about while interviewing their grandparents. This is a great opportunity to bring everyone together to share and embrace differences.

# MEETING 3 PLAN (International Food Picnic)

## PREPARATION AND MATERIALS NEEDED

- Have a sign-up sheet to list ahead of time which foods will be brought and which games will be played. Try to get a good balance of active and quiet games.
- Provide everyone with instructions on what to bring and how many their dish may need to feed. Also, if families will be teaching a game, be sure that they have all the equipment needed to play the game.
- Let Tigers and partners know that their entire family is invited.

## GATHERING

### Balloon Bounce

Give an inflated balloon to the first pair of Tigers to arrive. (Check for latex allergies in advance.) The object of the game is for the Tigers to keep the balloon in the air as long as possible by hitting it back and forth. As additional boys arrive, direct them to join the game. The game is over when the balloon touches the floor or bursts. Tigers are not permitted to catch or hold the balloon.

## OPENING

- Conduct a flag ceremony of your choosing that includes the Pledge of Allegiance and, as appropriate, the Scout Oath and Scout Law.

## TALK TIME

- Carry out business items for the den.
- Before starting the picnic and games, ask Tigers to volunteer reasons they think the Pledge of Allegiance was important for immigrants who came to America.

## ACTIVITIES

### ◆ Activity 1: International Food Picnic (Requirement 7)

This activity will be a time for fun and fellowship. Each of the Tigers and their adult partners will prepare a dish at home and bring it to share at the picnic. Each team can also bring a game and the equipment needed for that game.

## CLOSING

- Share about the importance of family and how important it is to work together.
- Allow Tigers to talk about the elder they were able to interview for requirement 4.
- Develop your reflection questions from the activity and the games the boys played.

## AFTER THE MEETING

- Record completion of requirements 4, 7, and 8. Confirm that all Tigers have completed pen pal correspondence for requirement 8.
- Work together to clean up the meeting place.

Upon completion of the Family Stories adventure, your Tigers will have earned the adventure loop shown here. Make sure they are recognized for their completion by presenting the adventure loops, to be worn on their belts, as soon as possible according to your pack's tradition.





# FLOATS AND BOATS



## RATIONALE FOR ADVENTURE

This adventure will teach Tigers about different types of boats, how to build a boat using recycled materials, and how to stay safe on the water.

## TAKEAWAYS FOR CUB SCOUTS

- Safety training
- Building skills
- Teamwork
- Problem solving
- Safety awareness
- Skill development
- A Scout is obedient, thrifty.



*Tiger Handbook, page 148*

## ADVENTURE REQUIREMENTS

1. Identify five different types of boats.
2. Build a boat from recycled materials, and float it on the water.
3. With your den, say the SCOUT water safety chant.
4. Play the buddy game with your den.
5. Show that you can put on and fasten a life jacket the correct way.
6. Show how to safely help someone who needs assistance in the water, without having to enter the water yourself.
7. Show how to enter the water safely, blow your breath out under the water, and do a prone glide.

### NOTES TO DEN LEADER

An overview of BSA swimming and water activities is included in the Appendix. In preparation for any in-water activity, you should complete the BSA online training for Safe Swim Defense. This training outlines how to help lead a safe swimming activity with a Cub Scout pack, Boy Scout troop, or Venturing crew. The training is available at [www.myscouting.org](http://www.myscouting.org).

Meeting 3 is an outing to a pool. Review the Meeting 3 Plan to plan ahead for this outing. In advance of the outing, the leader will need to make arrangements with the outing location and confirm the outing plan with families, including transportation and any additional items they need to bring. Make sure a tour and activity plan has been submitted, if required, and activity consent forms are distributed, signed, and collected.

Tigers will need to bring recycled materials to Meeting 2 for building boats.

See the Appendix for optional den meeting activities, including openings, gatherings, and closings.

# MEETING 1 PLAN

## PREPARATION AND MATERIALS NEEDED

- U.S. and den flags
- Read the Floats and Boats adventure in the *Tiger Handbook*.
- Review the Water Safety section in the *Cub Scout Leader Book* (No. 33221).
- Review the Safe Swim Defense policy. You can complete Safe Swim Defense training online at [www.myscouting.org](http://www.myscouting.org). Also review the *Guide to Safe Scouting*.
- Identify any parents or other adults in the pack who are, or know, lifeguards or water safety and swimming instructors. They could help with the meetings during this adventure.
- Many councils have aquatics committees that can help provide trained personnel, equipment access, and pool access. Check with your council service center for contact information.
- Items for Sink or Float Activity:
  - 4-by-4-inch pieces of foil (one per boy)
  - Dishpan or bucket
  - Pennies
  - Water for dishpan
- Poster or actual toy models of five different types of boats—or use the pictures in the *Tiger Handbook*
- Poster of the SCOUT water safety chant and each of the letters (S-C-O-U-T) on a separate piece of paper
- Cards with animal names—two cards per animal for the buddy game
- Materials for demonstrating rescue techniques

## GATHERING

**Sink or Float Activity:** Tigers will make a boat using one piece of precut aluminum foil. Encourage them to make several different shapes. Have them test their boats in a dishpan of water to see which one holds the most pennies without sinking.

## OPENING

- Conduct a flag ceremony of your choosing that includes the Pledge of Allegiance and, as appropriate, the Scout Oath and Scout Law.
- Adult partners help Tigers learn the Scout Oath.
- Sing the “Princess Pat” song. This is an echo song that is sung to the tune of “The Other Day I Met a Bear.” One or two people lead and the rest of the group follows, singing the words and imitating the motions of the leaders.

<b>The Princess Pat</b>	<b>Egyptian pose</b>
<b>lived in a tree.</b>	<b>Raise arms in a circle above your head.</b>
<b>She sailed across</b>	<b>Wave motion</b>
<b>the seven seas.</b>	<b>Hold up seven fingers, then form the letter “C” with your hand.</b>
<b>She sailed across</b>	<b>Wave motion</b>
<b>the channel, too.</b>	<b>Draw a box with fingers, and then hold up two fingers.</b>
<b>And she took with her</b>	<b>Hold both hands over shoulder as if holding a bag.</b>

<b>a rig-a-bam-boo!</b>	<b>Shake hands/arms all the way down!</b>
<b>He tried to cross</b>	<b>Wave motion</b>
<b>the channel, too.</b>	<b>Draw a box with fingers, and then hold up two fingers.</b>
<b>His ship did sink</b>	<b>Holding nose with one hand, raise other hand, shimmy, and squat.</b>
<b>and yours will, too.</b>	<b>Point to someone else.</b>
<b>If you don't take</b>	<b>Hold both hands over shoulder as if holding a bag.</b>
<b>a rig-a-bam-boo!</b>	<b>Shake hands/arms all the way down.</b>

## TALK TIME

- Carry out business items for the den.
- Make any necessary announcements.
- Ask Tigers to show which boat held the most pennies.
- Ask them to look at the shape of that boat and think about boats that might look like that in real life. Help them make a mental connection between their foil boat and barge boats that carry heavy loads.
- Introduce the Floats and Boats adventure to the den. Build interest by describing the goals of the adventure and some of the activities that are planned. Ask them to look at the shape of that boat and think about boats that might look like that in real life.

## ACTIVITIES

### ◆ Activity 1: Tall Sea Tale

- Introduce the new adventure to Tigers by creating an origami boat while telling a tall tale. Adult partners will lead the origami activity with their Tigers.
- Give each adult partner a copy of the origami folding instructions from the Meeting 1 Resources.
- Tell the tall tale and have each Tiger take turns saying something to fill in the blanks. This will be a “make your own” tall sea tale!

### Tall Sea Tale

A long time ago, in the ancient land of \_\_\_\_\_, there lived a young sailor named \_\_\_\_\_. He spent many days out on his boat pretending to \_\_\_\_\_. One day, a \_\_\_\_\_ suddenly jumped out of the water. The first thing the sailor said was, “\_\_\_\_\_.” At first, he was worried that it might \_\_\_\_\_. But instead, it \_\_\_\_\_, and the sailor said, “\_\_\_\_\_.” They both laughed because \_\_\_\_\_. The sailor said, “Hey, let’s go \_\_\_\_\_.” But then, out of nowhere came a \_\_\_\_\_, and they \_\_\_\_\_.

- After each sentence, have the adult partners help their Tigers to make another fold.
- By the end of the story, each Tiger will have his own sampan origami boat, and the den will have its tall sea tale!
- Explain that a sampan is a flat-bottomed boat used in China. There are many different types of boats that we will look at now.

## ◆ Activity 2: How Boats Move (Requirement 1)

- Use photos, drawings, or models of five different types of boats: rowboat, canoe, kayak, sailboat, and motorboat. Place each one in a different part of the room with a card that identifies the boat.
- Show Tigers and adult partners where each boat is located in the room. Tell Tigers that you will say a word that describes how each boat moves in the water. When they hear the word, they will go to the boat that moves in the way you described. Note: You can have them jump, hop, skip, or move in a different way each time to make it more fun for them and to avoid everyone running!

### Words to Use:

- Oars (rowboat)
- Paddles (canoe)
- Engine (motorboat)
- Wind (sailboat)
- Paddle (kayak)

- As the Tigers move to each boat, explain why the word is related to how the boat moves in the water.
- As a final activity to help the Tigers identify the boats, adult partners will act out motions for piloting each type of boat, and Tigers will guess which one it is.

### Boat Motions:

- Motorboat: Pretend you are holding a steering wheel and make an engine sound.
- Kayak: Sit with legs out in front of you and paddle, switching from one side to the other.
- Rowboat: Sit facing away from the boys and pretend to row with both hands.
- Canoe: Kneel on the floor and slowly stroke the air with two hands on one side.
- Sailboat: Pretend to be hoisting a sail.

## ◆ Activity 3: Water Safety Exercise (Requirement 3)

- Explain to the Tigers that when you ride in a boat or swim, safety is very important. To help them remember what is important, teach them the water safety chant. Refer to the Safety Chant Poster you created. (Note: This chant is done in a round. First, everyone says it together. Then one boy and his partner start with “S,” and when they get to “C” the next pair starts, and so on.)

### THE WATER SAFETY CHANT

S is **Someone's** watching.  
Never swim alone.

C is **Check** the rules.  
Know where you can roam.

O is **Only** buddies  
should go from the shore.

U is know what **“U”** can do.  
Don't do any more.

T is **Tell** a grown-up  
if someone's in need.

**SCOUT** shows safety.  
Now you take the lead.



- Once Tigers have learned the chant, adult partners can help the leader explain the rule that goes with each letter. As you do this, show the letter and repeat the words of the chant.
  - S**: *What do you need to make sure of before you go in the water?* An adult needs to be watching you.
  - C**: *What do you need to know before you swim?* Be sure you know the rules for the place where you will be swimming. *Is running near the pool or water's edge a good idea?* No!
  - O**: *Who should you always have with you when you swim?* You should always have a buddy.
  - U**: *What do you need to know about yourself before you go swimming?* Know where you are allowed to swim, and don't swim beyond that point. And, if you can't swim, don't enter water that is deeper than your chest. *How should you enter the water?* Enter feet first.
  - T**: *Who do you call for help?* Get an adult if someone needs help.

*What do these letters spell?* Scout spells safety, and YOU take the lead!

#### ◆ Activity 4: Buddy Game (Requirement 4)

Tell the boys that having a buddy is not only important when you are doing an activity, but it can also be fun! Divide the Tigers into buddy pairs. Proceed through the activity with these instructions:

- With your buddy, decide on an animal that your buddy pair is going to be. (Another option is for the leader to assign an animal name to each pair.)
- Next, the entire den gathers into a big circle, and each Tiger stands on the opposite side of the circle from his buddy. When the den leader says, "Go," close your eyes, turn around twice, and locate your buddy by using the noise that your animal makes—while listening for your buddy to do the same.
- When you find your buddy, join hands, raise your joined hands in the air, and stay where you are until all buddy pairs have finished the activity.

#### CLOSING

- Call for a buddy check with Tigers and adult partners. Have the buddies form a circle. Explain how this buddy system is used for safety when in the water.
- Call for a Tiger salute, and then have each Tiger pretend to leave the circle in a boat of his choosing.



#### Do-at-Home Project Reminder:

Bring materials for boat building to the next meeting. The boats will be made out of recycled materials. Also ask them to bring their own glue or tape if you will not be providing it.

#### AFTER THE MEETING

- Make sure everything is cleaned up.
- Serve refreshments, if desired.
- Plan the outing at a local pool or pond.
- Record completion of requirements 1, 3, and 4.

# MEETING 1 RESOURCES

## ORIGAMI SAMPAN BOAT

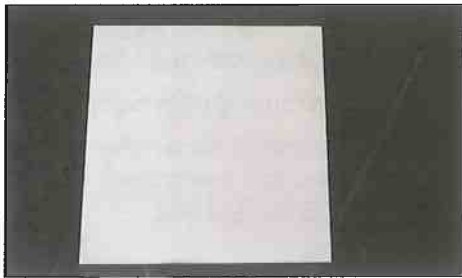

1. Place your paper with the white side facing up.



2. Fold the paper in half as shown.

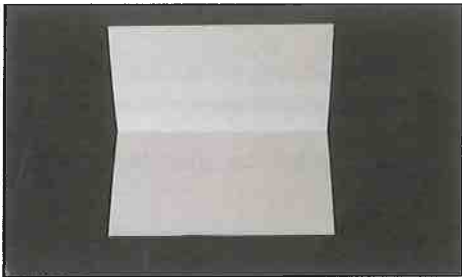

3. Unfold the paper.

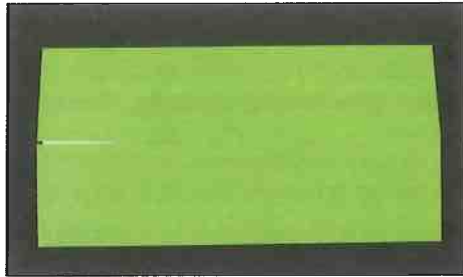

4. Fold the top and bottom edges to meet in the center crease.

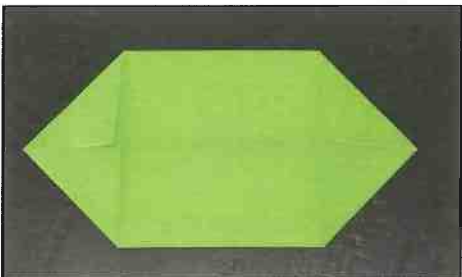

5. Fold each of the four corners in to meet at the center crease.

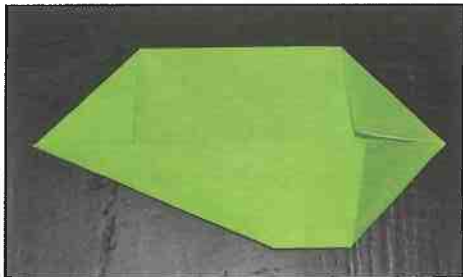

6. Again, fold one corner in to meet at the center crease.

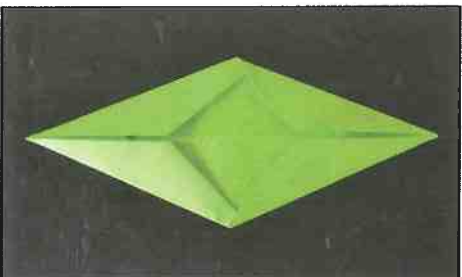

7. Do the same for all four corners. The folds will overlap.

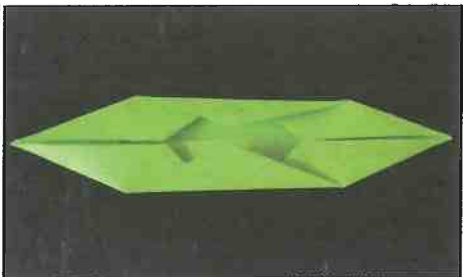

8. Fold the two middle points in to the center crease.



9. Open up the boat from the center, and carefully turn it inside out.



10. You're finished!

# MEETING 2 PLAN

## PREPARATION AND MATERIALS NEEDED

- U.S. and den flags
- Review the Water Safety section in the *Cub Scout Leader Book* (No. 33221) and the *Guide to Safe Scouting*.
- Identify any parents or other adults in the pack who are, or know, lifeguards or water safety and swimming instructors. They could possibly help with the meetings during this adventure.
- Life jackets for Tigers to try on. (If life jackets are not available, you may substitute a discussion on why they should be worn, along with visual aids to help in your discussion.)
- Recycled materials brought by the den members to be used for making boats. These may include milk cartons, egg cartons, plastic bottles, aluminum cans, straws, chenille stems, tissue paper, cardboard, craft sticks, and tape or glue.
- A rain gutter, tub, water table, or sink for floating the boats
- Posters showing various boats
- Tape, pool noodles, flying discs, balls, balloons, cardboard tubes, or whatever is available to use for the opening activity

## GATHERING: POOL NOODLE GAMES

- Turn pool noodles into rings to make a target station for flying discs, soccer balls, and more. Use a cardboard tube (like a toilet paper tube) to connect the ends of each pool noodle, wrapping tape around the connections to keep them secure. Use stakes to keep the target station upright.
- Cut several pool noodles in half so you can give one half to each player. Scatter blown-up balloons on the ground around a laundry basket. (Check for latex allergies first.) Players then see who can get the most balloons into the basket using only the noodle half.

## OPENING

- Call for a buddy check.
- Conduct a flag ceremony of your choosing that includes the Pledge of Allegiance and, as appropriate, the Scout Oath and Scout Law.

## TALK TIME

- Carry out business items for the den.
- Provide information about the upcoming outing.
- Explain that today's meeting is to continue work on the Floats and Boats adventure by constructing boats from recycled materials.

## ACTIVITIES

### ◆ Activity 1: Life Jacket Relay (Requirement 5)

- Demonstrate what a life jacket looks like when it is adjusted correctly. Life jackets come in adult, youth, child, and infant sizes. Check the life jacket label for the appropriate weight range. A life jacket must be worn with all straps and zippers properly fastened. Pull the adjustable straps until the life jacket fits snugly, but comfortably, over clothing worn for different weather conditions. A properly fitted life jacket will not ride up around the head when lifted by the shoulder straps or when supporting a person in the water; if it does, a smaller size is needed. Simply tightening the straps on an adult life jacket will not make it safe for a child.

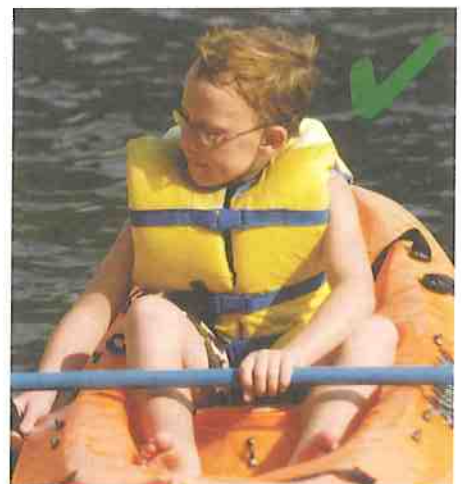

- Whenever you do a rowing activity on the open water, you must wear a U.S. Coast Guard–approved life jacket. Here are brief descriptions of the different types:



**Offshore Life Jacket:** These life jackets are generally used as emergency devices on commercial vessels. They are effective for all waters, especially open, rough, or remote waters where rescue may be delayed. They will turn most unconscious people face-up.



**Nearshore Buoyant Vest:** These life jackets will turn some unconscious people face-up. They are intended for calm, inland water, or where the chance of quick rescue is good. The familiar horse-collar styles are generally less expensive than any other type.



**Flotation Aid:** These life jackets are designed to help wearers achieve and maintain a face-up position in the water. They come in a wide variety of comfortable styles that allow a good range of motion.



**Special-Use Device:** The various special-use life jackets are designed for the specific industrial and recreational situations indicated on their labels.

**Throwable Devices:** These personal flotation devices may be thrown to boaters in need. They are to be grasped by a swimmer, not worn.



- Line Tigers up at one end of the room with life jackets laid out on the other end.
- Each Tiger will run across, put on a life jacket, and adjust it. His adult partner will check to make sure that it fits.
- Then the Tiger will take off the life jacket and run back to tag the next boy, who will continue the relay with his adult partner.
- Keep going until everyone has had a turn in the relay.

### ◆ Activity 2: Boat Building (Requirement 2)

- Tell the Tigers to remember the types of boats they learned about during the last meeting. Ask them what makes each boat special. Which one is their favorite?
- Each Tiger, with his adult partner, will then design and build a boat using the recycled materials available. Tell the Tigers that recycled materials are things that can be used again, such as plastic, newspaper, and cardboard. Remember, a Scout is thrifty and can help save money by reusing things he already has instead of buying new things.
- The boat a Tiger builds can be his favorite type or a combination of different types. Ask each boy what his boat will be used as: a cruise ship, sailboat, motorboat, paddleboat, rowboat, canoe, or something else. Make sure that he also gives the boat a name!

### ◆ Activity 3: Boat Races

- Race the boats in a rain gutter, water table, tub, or sink.
- After the race, start a discussion by asking the Tigers why they think some boats were faster than others (material, movement “mechanics,” size).
- Show them pictures of a variety of actual boats (e.g., canoe, sailboat, motorboat, yacht) and mention that these are all powered by different things (people, wind, engines).

## CLOSING

- Have a buddy check with adult partners.
- Announce details for the outing to visit a local pool or pond. Confirm that transportation plans are in place and families are aware of the date, time, and location of the outing.
- Close with the “Skipper Says” game. The den leader is “Skipper” and acts like Simon in the game “Simon Says.” Call out commands such as:
  - Skipper says, “Pilot a rowboat.”
  - Skipper says, “Pilot a paddleboat.”
  - Skipper says, “Put on a life jacket.”
  - Skipper says, “Help pilot a motorboat.”
  - Skipper says, “Say the Cub Scout motto.”
  - Skipper says, “Cub Scout salute!”

## AFTER THE MEETING

- Work together to clean up the meeting place.
- Serve refreshments, if desired.
- Record completion of requirements 2 and 5.

# MEETING 3 PLAN (Den Outing)

### NOTE TO DEN LEADER

Requirements 6 and 7 can be satisfied at day camp or resident camp if the program allows for it, or during one or more meeting/outing sessions.

## PREPARATION AND MATERIALS NEEDED

- Make arrangements for the Tigers to swim at a pool. Arrange for adequate adult supervision.
- All trips by units that involve swimming activities require a tour and activity plan. The form is available at [www.scouting.org/filestore/pdf/680-014.pdf](http://www.scouting.org/filestore/pdf/680-014.pdf).
- Unit den leader should have in possession (if required by local council practices) the tour and activity plan, signed activity consent forms, and a copy of the *Guide to Safe Scouting*.
- Have parents and leaders take the Safe Swim Defense online training at [www.myscouting.org](http://www.myscouting.org). Be sure that at least one of the adult leaders supervising these activities has completed the training.
- The *Cub Scout Leader Book* provides information on conducting water activities with your den or pack.
- Only experienced, trained individuals should provide swimming instruction.
- Information on all swimming strokes, the BSA swimmer test, and rescue techniques is available from several sources including *Aquatics Supervision: A Leader's Guide to Youth Swimming and Boating Activities* (No. 34346), the *Swimming and Lifesaving* merit badge pamphlets, the *Webelos Handbook*, and online:
  - American Red Cross, [www.redcross.org](http://www.redcross.org) or 800-733-2767
  - USA Swimming, [www.usaswimming.org](http://www.usaswimming.org), search for Make a Splash
  - YMCA, [www.ymca.net](http://www.ymca.net) or 800-872-9622, or contact your local YMCA
- Long pool noodles

## GATHERING

- Remind the boys of appropriate behavior, including safety considerations, at the site of your visit. A Scout is courteous while visiting other places.
- Before entering the water, leaders need to make sure all Tigers know the basic water safety rules. Most pools should have these rules posted; if so, start the meeting with everyone gathered in front of this sign. Basic rules show how to safely enter and exit the water, forbid running near the pool, and explain what to do in case someone is in trouble.

## OPENING

- Say the Pledge of Allegiance and, as appropriate, the Scout Oath and Scout Law. If the den does not have a United States flag on the outing, ask one Scout to display the flag on his uniform for the group.

## ACTIVITIES

### ◆ Activity 1: Helping Safely (Requirement 6)

- The adult leader calls for a buddy check to make sure everyone has a buddy during this meeting.
- Discuss and demonstrate how a Tiger can use the reach rescue techniques to help a swimmer in trouble without placing himself in danger:
  - **REACH with whatever is on hand.**
    - One adult will be in the shallow area of the pool.
    - Line up Tigers on the edge of the pool.
    - An adult in the water demonstrates drowning behaviors, as shown in the online Safe Swim Defense training video.
    - Show each Tiger how to reach for the adult using a pool noodle. Have the Tigers lie flat on their stomachs on the side of the pool and reach for the adult using the noodle.
- Tell Tigers: No Cub Scout should ever put himself in danger or at risk. If reaching doesn't work, get help!

### ◆ Activity 2: Swimming Fun! (Requirement 7)

- Let Tigers who are comfortable in the water try blowing bubbles—by blowing air out through their mouths. If a boy isn't comfortable doing this, he can try putting a towel over his face, dipping it briefly into the water and blowing bubbles through the towel.
- Have all the boys simulate "flying" (like Superman) when pushing off the wall (this is the prone glide).
- After all Scouts have tried the prone glide (required) and blowing bubbles in the water, allow them to play water games.

## CLOSING

- Say the SCOUT safety chant while splashing in the water.

## AFTER THE MEETING

- Serve refreshments, if desired.
- Check for any items that may have been left in the pool area or changing rooms. Ensure cleanup takes place.
- Prepare thank-you notes for everyone who helped with this activity—such as lifeguards or other staff.
- Record completion of requirements 6 and 7.

Upon completion of the Floats and Boats adventure, your Tigers will have earned the adventure loop shown here. Make sure they are recognized for their completion by presenting the adventure loops, to be worn on their belts, as soon as possible according to your pack's tradition.





# GOOD KNIGHTS



## RATIONALE FOR ADVENTURE

This adventure will help Tigers realize that the Scout Law is a code of conduct they can follow to make their bodies and minds stronger.

## TAKEAWAYS FOR CUB SCOUTS

- Understanding of teamwork
- Problem solving
- Creating a game
- Creating a den plan for good manners
- Strengthening relationships through attitude
- Connecting the Scout Law and daily life
- Taking care of the earth by recycling

## ADVENTURE REQUIREMENTS

*Tiger Handbook, page 162*

1. Do the following:
  - a. With your den or adult partner, say the Scout Law. Explain to your den one of the 12 points of the Law and why you think a knight would have the same behavior.
  - b. If you have not already done so, make a code of conduct with your den that will describe how each person should act when you are all together. If your den has a code of conduct, discuss with your den the updates it might need. Vote on which actions should go in your den code of conduct.
2. Create a den shield and a personal shield.
3. Using recycled materials, design and build a small castle with your adult partner to display at the pack meeting.
4. Think of one physical challenge that could be part of an obstacle course. Then help your den design a Tiger knight obstacle course. With your adult partner, participate in the course.
5. Participate in a service project.

### NOTES TO DEN LEADER

Meeting 2 will include a castle-building activity that requires recycled materials. Begin collecting these materials well in advance to have a good variety for Tigers to use.

Meeting 3 is a den outing for a service project. See the Meeting 3 Plan for preparation details, and be sure to begin planning well in advance. In advance of the outing, the leader will need to make arrangements with the outing location and confirm the outing plan with families, including transportation and any additional items they need to bring. Make sure a tour and activity plan has been submitted, if required, and activity consent forms are distributed, signed, and collected.

See the Appendix for optional den meeting activities, including openings, gatherings, and closings.

# MEETING 1 PLAN

## PREPARATION AND MATERIALS NEEDED

- U.S. and den flags
- Printed copy of the Scout Law
- Thank-you note, or materials to make a simple card
- Poster board and materials to make shields (pencils, scissors, crayons or other coloring tools). If possible, create your own shield to use as an example.
- Printouts or books with information about knights
- Materials for Gathering: buckets and water if outdoors; buckets and cotton balls or rolled-up socks if inside
- Remind parents that the castle-building requirement will use recycled materials, which they may want to start collecting.
- Suggestion: Prepare a handout about what to bring to the next meeting for making castles (recycled materials, markers, paper, glue, scissors, etc.) as well as a shield template for each Tiger to use to create his personal shield (see Do-at-Home Project Reminder).
- Read the Good Knights adventure in the *Tiger Handbook*.

## GATHERING

Games are a great way to keep the boys busy until you are ready to start.

### Merlin's Magic Potion Game

The concept is to transfer the contents of a bucket of water from one end of the room or yard to a bucket at the other end. If you are indoors, use cotton balls or rolled-up pairs of socks instead of water.

#### Materials:

- A set of "potions" for each team
    - Outdoors: Use cups of colored water.
    - Indoors: Use cups filled with cotton balls.
  - 2 large containers
1. Divide the Tigers into teams. Or, if you are waiting for everyone to arrive, have each boy race against his best time.
  2. At the word "Go!" players transfer their "potions" from one container to the other as quickly as they can.

## OPENING

- Conduct a flag ceremony of your choosing that includes the Pledge of Allegiance and, as appropriate, the Scout Oath and Scout Law.

## TALK TIME

- Introduce the Good Knights adventure to the den. Build interest by describing the goals of the adventure and some of the activities that are planned.
- Carry out business items for the den.
- Give each Tiger time to share information about his week. You might use a talking stick or other item to help moderate the time and encourage respect.



## ACTIVITIES

### ◆ Activity 1: What Makes a Knight? (Requirement 1a)

1. Using the Scout Law as an example, talk to the boys about knights. Explain chivalry and the code of conduct. Chivalry means the ideal qualifications of a knight, including courtesy, generosity, and bravery. As you discuss these qualities and work at creating a den code of conduct, emphasize that chivalry has characteristics similar to the Scout Law. Chivalrous conduct was about friendly service to others. Tigers can learn to practice chivalry in the 21st century.
2. Have each Tiger choose a point of the Scout Law so he can think about how it relates to a knight's code of conduct.
3. Remember to engage the Tigers by asking questions and encouraging their ideas. While it is important to teach these points thoroughly, keep it short so you will have plenty of time for the active part of the meeting—making the shields.

### ◆ Activity 2: Making a Den Shield (Requirement 2)

1. Show examples of shields, including the one that you have made for yourself. Have the boys work together to make their den shield.
2. Types of images that could be used include birds, animals, Scouts, American Indian symbols, sporting equipment, etc. Note: We are asking the Tigers to draw images they feel relate to the Scout Law, so don't focus on "the knights of old."

### ◆ Activity 3: Den Code of Conduct (Requirement 1b)

1. Vote on ideas to include in a den code of conduct.
2. Some ideas might be to show respect for others, keep the meeting area clean, and be helpful to other Scouts. Try to incorporate the Scout Law into this code of conduct.
3. Collect all ideas on a chart that can be used during each meeting.

#### NOTE TO DEN LEADER

Keep the code of conduct brief—no more than five or six items. Keeping it simple will make it easier for the Tigers to follow the guidelines they set.

## CLOSING

- Have the boys recite the den code of conduct together.
- Remind Tigers to complete the Do-at-Home Project part of requirement 2 (see below). Tigers can look at the *Tiger Handbook* for ideas.
- Hand out the list of things to bring for the castle activity at the next meeting.
- Reflect briefly on the team cooperation they used in voting on the den code of conduct.



#### Do-at-Home Project Reminder:

For the next meeting, Tigers will need to bring recycled materials and other items from home to create castles.

Tigers will also create their own personal shields to present at the next meeting (requirement 2). Shields should include drawings and symbols that represent who they are. Tigers can use a variety of materials and shapes to create their shields. They should think about how the pictures on their shields relate to points of the Scout Law.

## AFTER THE MEETING

- Serve refreshments, if desired.
- Record completion of requirements 1a and 1b.
- Work together to clean up the meeting place.

# MEETING 2 PLAN

## PREPARATION AND MATERIALS NEEDED

- U.S. and den flags
- Various recyclables, such as cereal boxes, clean empty cans, paper towel tubes, construction paper, craft sticks, etc.
- Glue
- Markers, crayons, or paints to color the castle (optional)
- A selection of various items that could be used in an obstacle course, including pool noodles, hula hoops, balls, pails, discs, stick horses, etc.

## GATHERING

**Dragon Tag:** One boy starts as the dragon. When he catches one of the other players, the dragon “grows”: The player who was caught holds on to the original dragon, and both of them run as one unit as they try to catch another player. Each time a boy is caught, the dragon “grows” until there is no one left.

Note: Be sure to establish ahead of time where the boys should hold on to each other (e.g., belt or sleeve). For safety reasons, be sure that they do not hold on to the back of one another’s shirts or collars.

## OPENING

- Conduct a flag ceremony of your choosing that includes the Pledge of Allegiance and, as appropriate, the Scout Oath and Scout Law.
- Recite the den code of conduct.

## TALK TIME

- Carry out business items for the den.
- Share that the knights of old stood straight and tall as they pledged themselves to defend all things that were good and to strive to always do right. Have each Tiger share a way he can be similar to a knight. Invite each Tiger to share his personal shield (requirement 2).

## ACTIVITIES

### ◆ Activity 1: Building Castles (Requirement 3)

1. Using the materials listed above, have each Tiger design and build a small castle for display at the pack meeting. Remember to let the Tigers use their imaginations; adult partners should mainly assist with cutting and gluing.
2. Point out how we can reuse common household items to create new things (a Scout is thrifty). Adult partners may encourage their Tigers to add bridges, towers, flags, moats, and people to their castles. The castles can be tall and narrow, round, or square.
3. Here are some questions to share with your Tigers after they finish the activity:
  - What was the easiest way to build your castles?
  - What was your biggest challenge and how did you solve it?
  - How would living in a castle be different from living in your home?
4. Have the Tigers help clean up. This teaches them to respect their surroundings.
5. Remind Tigers to bring their castles to the pack meeting. If there is a chance any boy will miss the meeting, offer to bring his castle and return it to him later. Also, Tigers may want to display their personal shields with the castles.

## ◆ Activity 2: Creating an Obstacle Course (Requirement 4)

### Materials needed:

- Possible items for the obstacle course are pool noodles, hula hoops, balls, pails, discs, stick horses, etc.
- If you want to include balloons, be sure there are no latex allergies in your den.

### Instructions:

1. Show the den the items you have gathered, and describe jousting tournaments as knights would have experienced them.
2. Be sure that the boys understand they will NOT be jousting with one another. Instead, they will create an obstacle course where they challenge themselves—not each other—as individuals who “do their best” (Cub Scout motto).
3. Help the boys to develop a simple course. (The den leader should plan the jousting section to ensure safety.) Developing the games for the course should not take much time. For example, Tigers can sharpen their coordination and balance by using a pool noodle to hit a target. They might use the noodle to try hitting a balloon while galloping by on a stick horse or broom. They may also try throwing the noodle through a ring or a hula hoop. Other ideas include crab walking, running, hopping, kicking a ball, throwing a ball through a hoop, throwing a ball into a bucket, etc.
4. Encourage the Tigers to think of each boy in their den. If any of the boys has a physical or mental disability, foster den unity by ensuring they are all included.
5. Show the Tigers all the materials they have to build the obstacle course, and keep it simple and fun. Take a few minutes to discuss fair conduct rules.
6. Finally, set up and play the games. There are several ways this could be conducted: boys in teams against the adults, boys with their adult partners, mix everyone up, etc. If there is an interest in competing for the “best” time, be sure to make the competition constructive and positive—and focused on growth.

### CLOSING

- While the boys are resting after the games, encourage them to talk about how things went. Ask leading questions versus yes or no questions. What part was the hardest? What made their muscles work the most? Was it easier or more difficult than they expected to launch the pool noodle through the hoop?
- Review details for the Den Meeting 3 outing. Make sure all Tigers and their families know the plans.

### AFTER THE MEETING

- Serve refreshments, if desired.
- Record completion of requirements 2, 3, and 4.
- Work together to clean up the meeting place.

## MEETING 3 PLAN (Den Outing)

### PREPARATION AND MATERIALS NEEDED

- U.S. and den flags
- Keep an eye on your community calendar for opportunities to serve. Tailor service ideas to this age group. Ideas could include, but are not limited to, the following:
  - Planting flowers or singing for a nursing home
  - Collecting food for a food bank
  - Making a meal for a soup kitchen
  - Collecting supplies for a shelter
  - Raking leaves
  - Picking up trash (Make sure everyone wears gloves, and remind Tigers not to pick up sharp objects.)

- Unit den leader should have in possession (if required by local council practices) the tour and activity plan, signed activity consent forms, and a copy of the *Guide to Safe Scouting*.

## GATHERING

- Explain to your Scouts what to expect on the outing.
- Practice introductions.
- Cover information such as bathroom breaks and the buddy system.
- Talk about any safety issues (gloves for trash, what is safe to touch, and when to get an adult).
- Answer any questions that arise.

## OPENING

- Say the Pledge of Allegiance and, as appropriate, the Scout Oath and Scout Law. If the den does not have a United States flag on the outing, ask one Scout to display the flag on his uniform for the group.

## TALK TIME

- Carry out business items for the den.

## ACTIVITIES

### ◆ Activity 1: Service Project (Requirement 5)

Working as a Tiger team, complete the service project chosen by the den.

## CLOSING

- Thank the person or people in charge of your service project.
- Compliment the boys on their behavior.
- Consider a short reflection period, especially if it was a long activity. This can be as simple as asking Tigers to share their favorite part of the project. Encouraging boys to identify the positive feelings they receive when they serve others will help them to associate happiness and service. This is a perfect time to review the points of the Scout Law and identify which ones pertain to the service activity.
- Announce any information for the next meeting.

## AFTER THE MEETING

- Serve refreshments, if desired.
- Record completion of requirement 5.
- Work together to clean up the meeting place.

Upon completion of the Good Knights adventure, your Tigers will have earned the adventure loop shown here. Make sure they are recognized for their completion by presenting the adventure loops, to be worn on their belts, as soon as possible according to your pack's tradition.





# ROLLING TIGERS



## RATIONALE FOR ADVENTURE

In this adventure, Tigers will learn about their bicycles, safety gear, and how to keep safe and have fun while riding.

## TAKEAWAYS FOR CUB SCOUTS

- Increasing responsibility
- Developing confidence
- Following instructions
- Learning rules
- Learning safety skills
- Being observant
- A Scout is obedient. 

*Tiger Handbook, page 174*

## ADVENTURE REQUIREMENTS

1. With your den or adult partner, discuss two different types of bicycles and their uses.
2. With your den or adult partner, try on safety gear you should use while riding your bike. Show how to wear a bicycle helmet properly.
3. With your den or adult partner, learn and demonstrate safety tips to follow when riding your bicycle.
4. Learn and demonstrate proper hand signals.
5. With your den or adult partner, do a safety check on your bicycle.
6. With your den or family, go on a bicycle hike wearing your safety equipment. Follow the bicycling safety and traffic laws.
7. Learn about a famous bicycle race or famous cyclist. Share what you learn with your den.
8. Visit your local or state police department to learn about bicycle-riding laws.
9. Identify two jobs that use bicycles.

### NOTES TO DEN LEADER

Meeting 1 will be an introduction to bicycle gear and safety; Tigers can plan to bring their own bikes to the meeting. Meeting 2 will be a den bike hike. Before the hike, check to make sure all the Tigers and adult partners have bikes and safety gear. If not, look into options for borrowing so everyone will have what they need.

Meeting 3 will be a den outing to a state or local police department. In advance of the outing, the leader will need to make arrangements with the outing location and confirm the outing plan with families, including transportation and any additional items they need to bring. Make sure a tour and activity plan has been submitted, if required, and activity consent forms are distributed, signed, and collected.

Safety Equipment: In addition to bikes, each Cub Scout and adult partner will need the safety equipment spelled out in Meeting 1. Make arrangements in advance with families to supply these items, or develop a plan to borrow them.

See the Appendix for optional den meeting activities, including openings, gatherings, and closings.

# MEETING 1 PLAN

## PREPARATION AND MATERIALS NEEDED

- U.S. and den flags
- Copies of the Scout Oath and Scout Law
- Posters or pictures of different types of bicycles, or books about bicycles
- Bicycle safety gear (helmets, knee pads, elbow pads, and gloves) will be needed for both youth and adults. Before the meeting, ask Tigers and their adult partners which items they have to be sure nothing is left out.
- Stopwatch or timer
- If possible, have Tigers bring their bicycles to the meeting. Make sure each Tiger has a bicycle to use, including the safety gear noted above. Or, bring in a sample bike and gear for show.
- Two large poster-size pieces of paper for listing “Safety Tips” and “Safety Gear.” There are downloadable PDFs available from the National Highway Traffic Safety Administration that can be used as reference. See [www.nhtsa.gov/Bicycles](http://www.nhtsa.gov/Bicycles).
- Read the Rolling Tigers adventure in the *Tiger Handbook*.

## GATHERING

Put the safety gear on display for the Tigers to see. Explain the purpose of each item and how it is worn. Time each of the Tigers to see how fast he can put on the gear correctly. The adult partners can participate as well.

## OPENING

- Conduct a flag ceremony of your choosing that includes the Pledge of Allegiance and, as appropriate, the Scout Oath and Scout Law.

## TALK TIME (REQUIREMENT 1)

- Carry out business items for the den.
- This meeting is an introduction to the Rolling Tigers adventure. As the meeting starts, explain to the Tigers and adult partners that they will be talking about bicycles at this meeting. Give each Tiger an opportunity to tell you a little bit about his bicycle, if he has one. Have pictures or, if possible, real examples of different types of bicycles (tricycle, unicycle, mountain bike, tandem, three-wheeler, and motocross). Find out how each bike is used.

## ACTIVITIES

### ◆ Activity 1: Safety Gear (Requirement 2)

- Ask Tigers how fast they were able to put on the safety gear earlier. Be sure to note that speed comes second to putting on gear correctly!
- Give each Tiger one safety gear item and ask him to tell why we would wear it when biking. Establish the importance of using safety gear.
- As another option, create the “Safety Gear” list on a poster board with reasons why each item is used.
- Review the proper steps for putting on a helmet as outlined in the *Tiger Handbook*. Give each Tiger the opportunity to try on his helmet and check the fit.

### ◆ Activity 2: Safety Tips (Requirement 3)

- Talk about the importance of bicycle safety by asking Tigers how they bike safely.
- Create a list of their ideas on the poster labeled “Safety Tips.”
- Remind them that they must follow state laws while riding their bicycles.
- Review the list of bike safety tips in the *Tiger Handbook*.

### ◆ Activity 3: Hand Signals (Requirement 4)

- Demonstrate the arm signals that Tigers should use when out on the road. Have Tigers look at the examples in their handbooks to reinforce each.
- Teach and practice the skills by playing a game similar to “Simon Says.” The game can be played with all of the boys lined up behind the leader, who signals an action and then either follows the signal or does not follow the signal correctly. Have fun!

### ◆ Activity 4: Driving Test

Go outdoors and do the Driving Test. This game is set up to be played with bicycles. You will need to modify this game depending on the amount of time you have to play, or whether or not the Tigers have bicycles to ride.

1. All players except for one form a large circle about 30 feet wide.
2. The one remaining player mounts his bicycle inside the circle and rides slowly toward one of the other players.
3. When he is about halfway, the player he is riding toward calls out a command, such as “Turn right,” “Turn left,” or “Stop!”
4. The rider must give the proper signal and carry out the command. He continues to ride, carrying out the commands given to him by other boys.
5. After five commands, he takes a place in the circle and another player rides the course. Score 1 point for each correct signal. Have each of the boys take a turn, and the boy with the most points wins.

## CLOSING

- Spend a few moments reflecting on the information shared with the Tigers and the game that they played. Ask them one new thing that they learned during the meeting. How did they like the Driving Test? Did they find it hard to respond quickly and correctly to the commands? Why is being obedient important enough that it is included in the Scout Law?
- Have Tigers sign a thank-you card to be given after Meeting 3 to anyone who helps with the den outing.
- Confirm the details of the next meeting’s bike hike with Tigers and their adult partners.
- Lead the den in a Tiger roar to close out the meeting.

## AFTER THE MEETING

- Record completion of requirements 1, 2, 3, and 4.
- Work together to clean up the meeting place.

# MEETING 1 RESOURCES

## LIST OF CYCLING ORGANIZATIONS

### Adventure Cycling Association

150 E. Pine St., P.O. Box 8308  
Missoula, MT 59807  
Phone: 406-721-1776, 800-755-2453 (toll free)  
Fax: 406-721-8754  
Website: [www.adventurecycling.org](http://www.adventurecycling.org)

### American Bicycle Association

P.O. Box 718  
Chandler, AZ 85244  
Phone: 480-961-1903; fax: 480-961-1842  
Website: [www.ababmx.com](http://www.ababmx.com)  
Sanctions American BMX bicycling.

### National Center for Bicycling & Walking (NCBW)

Phone: 202-223-3621  
Website: [www.bikewalk.org](http://www.bikewalk.org)  
Promotes bicycling transportation and recreation and provides information to bicycle activists and government officials.

### Bicycle Helmet Safety Institute

4611 Seventh St. S  
Arlington, VA 22204-1419  
Phone: 703-486-0100  
Website: [www.bhsi.org](http://www.bhsi.org)  
A helmet advocacy program of the Washington Area Bicyclist Association. Provides information about helmets and safety.

### League of American Bicyclists

1612 K St. NW, Suite 308  
Washington, DC 20006-2850  
Phone: 202-822-1333; fax: 202-822-1334  
Website: [www.bikeleague.org](http://www.bikeleague.org)  
National organization of bicycle enthusiasts. Promotes bicycling for recreation and transportation and increases bicycle safety awareness by educating bicyclists and road users.

### National Bicycle League

3958 Brown Park Drive, Suite D  
Hilliard, OH 43026  
Phone: 614-777-1625, 800-886-BMX1 (toll free)  
Fax: 614-777-1680  
Website: [www.nbl.org](http://www.nbl.org)  
Sanctions BMX, Formula One, and freestyle bicycling.

### USA Cycling

210 USA Cycling Point, Suite 100  
Colorado Springs, CO 80919  
Phone: 719-434-4200  
Website: [www.usacycling.org](http://www.usacycling.org)  
The national body for competitive cycling in the United States.

## MEETING 2 PLAN (Bicycle Hike)

### PREPARATION AND MATERIALS NEEDED

- Bicycle and safety gear for each Tiger and adult partner
- There is a possibility that a Tiger or adult partner may not have a bicycle. If this happens, see if one or more bicycles can be borrowed before the hike.
- Hike map

### GATHERING

As boys and partners gather, have them point out their gear that matches what's on the bicycle gear poster from Meeting 1. Have them do the same as new bikes and riders arrive.

### OPENING

- Say the Pledge of Allegiance and, as appropriate, the Scout Oath and Scout Law. If the den does not have a United States flag on the outing, ask one Scout to display the flag on his uniform for the group.

### TALK TIME

- Carry out business items for the den.
- Tell everyone where the ride will start and the destination. Review signals for stopping and for making left and right turns.



## ACTIVITIES

### ◆ Activity 1: Safety Check (Requirement 5)

- Before the hike begins, conduct a safety check of the bicycles and safety gear. Also check to make sure all Tigers and adult partners understand the traffic laws that apply to bicycle riding.
- See the Meeting 2 Resources for more information on conducting a bicycle safety check.

### ◆ Activity 2: Bike Hike (Requirement 6)

Participate in the bicycle hike, and have fun!

## CLOSING

- Help Tigers see that bicycling is not just lots of fun, but also good exercise.
- Review the importance of safety when riding a bicycle: obeying all traffic laws, wearing safety gear, and learning the safety tips.
- Ask Tigers reflection questions such as these:
  - What did you like best about the bicycle hike?
  - Why is it important to take care of your bicycle?
  - Why is it important to wear safety gear?
  - How did knowing the traffic laws relating to bicycling help them on this hike?



### Do-at-Home Project Reminder:

Remind each family to learn a few facts about a famous bicycle race or cyclist so a discussion can occur in Meeting 3.

## AFTER THE MEETING

- Serve refreshments, if desired; then make sure everything is cleaned up.
- Record completion of requirements 5 and 6.
- If the next meeting will be an outing to a police station, distribute all pertinent information (where to go, transportation plans).

## MEETING 2 RESOURCES

### BICYCLE SAFETY CHECK

Before the hike, Tigers should read the information in their handbooks on how to check their bikes for safety. Leaders and adult partners should visit the National Highway Traffic Safety Administration website for more bike safety information: [www.nhtsa.gov/Bicycles](http://www.nhtsa.gov/Bicycles).

Before any bike ride, remember to:

1. Wear a bicycle helmet. Check to be sure it is properly fitted.
2. Check the air pressure in the tires. Spin the wheels to be sure they are not worn out.
3. Check the brakes.
4. Check the cranks, the chain, and the gears. Be sure they all move only as intended and do not have rust or too much grease.
5. Adjust the bicycle to fit. Stand over the bike. For a road bike, there should be 1 to 2 inches between the rider and the tube (bar). For a mountain bike, there should be 3 to 4 inches. Check that the seat is flat and not tilted. When sitting on the bike, check that the height is correct by extending one leg fully on the pedal. There should be a slight bend at the knee.
6. Check that any other gear, including reflectors, is in place as needed.

# MEETING 3 PLAN (Den Outing)

## PREPARATION AND MATERIALS NEEDED

- Contact the local or state police department ahead of time to make arrangements. Let them know how many adults and youth will be coming and what it is you are hoping to get out of the visit.
- Ask if there will be any hands-on opportunities for the boys. Can they bring their bicycles? If any boy in the den does not have a bicycle, have one of the Tigers share with him.
- Ask the police if they can set up an obstacle course for the Tigers to go through on their bicycles. Can they help the boys do a bicycle inspection?
- Unit den leader should have in possession (if required by local council practices) the tour and activity plan, signed activity consent forms, and a copy of the *Guide to Safe Scouting*.

## GATHERING

Explain to the boys what is expected of them, including quiet, courteous behavior. Generate a list of questions that they want to ask. Use the buddy system.

## OPENING

Say the Pledge of Allegiance and, as appropriate, the Scout Oath and Scout Law. If the den does not have a United States flag on the outing, ask one Scout to display the flag on his uniform for the group.

## TALK TIME (REQUIREMENTS 7 AND 9)

- Carry out business items for the den.
- Ask boys to volunteer what they learned about either a famous bicycle race or a famous cyclist.
- Discuss different jobs people can have that involve bicycles.

## ACTIVITIES

### ◆ Activity 1: Police Department Visit (Requirement 8)

- Visit the local or state police department to learn about laws, safety, and how to properly wear a helmet. Do a safety check on a bicycle if possible.
- Encourage the Tigers to ask the police questions about biking.

## CLOSING

- Thank those who were in charge of the visit. Plan a cheer ahead of time to give to them. Give them the thank-you cards that were signed at a previous meeting.
- If time allows, and there is an area to do so, gather the boys to talk about what they learned and how they felt about the visit.

## AFTER THE MEETING

- Record completion of requirements 7, 8, and 9.
- Provide refreshments, if allowed. Make sure everything is cleaned up.

Upon completion of the Rolling Tigers adventure, your Tigers will have earned the adventure loop shown here. Make sure they are recognized for their completion by presenting the adventure loops, to be worn on their belts, as soon as possible according to your pack's tradition.





# SKY IS THE LIMIT



## RATIONALE FOR ADVENTURE

This adventure will help Tigers learn about the mysterious night sky.

## TAKEAWAYS FOR CUB SCOUTS

- Practicing observation and listening skills
- Increasing confidence
- Developing the ability to speak in front of a group
- Following instructions
- Working as a team
- Taking care of the environment
- A Scout is reverent. 

*Tiger Handbook, page 188*

## ADVENTURE REQUIREMENTS

1. With your den or adult partner, go outside to observe the night sky. Talk about objects you see or might see.
2. Look at a distant object through a telescope or binoculars. Show how to focus the device you chose.
3. Observe in the sky or select from a book or chart two constellations that are easy to see in the night sky. With your adult partner, find out the names of the stars that make up the constellation and how the constellation got its name. Share what you found with your den.
4. Create and name your own constellation. Share your constellation with your den.
5. Create a homemade constellation.
6. Find out about two different jobs related to astronomy. Share this information with your den.
7. Find out about two astronauts who were Scouts when they were younger. Share what you learned with your den.
8. With your den or family, visit a planetarium, observatory, science museum, astronomy club, or college or high school astronomy teacher. Before you go, write down questions you might want to ask. Share what you learned.

### NOTES TO DEN LEADER

The Meeting 2 Plan includes a night hike to observe the night sky. This activity could take place during Meeting 2 or at home with Tigers and adult partners.

Tigers will have a Do-at-Home Project between Meeting 2 and Meeting 3 to complete requirement 4.

Meeting 3 will be an outing to a planetarium, science museum, or other institution where Tigers can learn about the stars from an expert. In advance of the outing, the leader will need to make arrangements with the outing location and confirm the outing plan with families, including transportation and any additional items they need to bring. Make sure a tour and activity plan has been submitted, if required, and activity consent forms are distributed, signed, and collected.

See the Appendix for optional den meeting activities, including openings, gatherings, and closings.

# MEETING 1 PLAN

## PREPARATION AND MATERIALS NEEDED

- Research some interesting facts about astronauts. Neil Armstrong and Charles Duke Jr. are mentioned in the opening ceremony. You could find out some interesting facts about them to share with the Tigers during Talk Time.
- Materials for Moon Rock Hunt: moon rocks made from pieces of foam mattress or painted rocks, a collection pail for each team, metal tongs to pick up rocks
- Materials for Constellation Match: 12 to 15 4-by-6-inch index cards for each boy, pictures of constellations (4 by 6 inches or smaller) for mounting on the cards, scissors, glue
- Provide a copy of the Quattro game board and playing pieces such as mini-marshmallows versus Goldfish crackers. (See Meeting 1 Resources for a sample of the game board. This can also be drawn freehand.)
- Materials for making tie slides, based on the type of slide chosen:
  - Plaster of paris star: star candy mold, plaster of paris, glitter, markers, and chenille stems or 2-inch pieces of PVC pipe
  - Wood or cardboard star: precut star, paint, glue, stickers, and the chenille stems or pipe pieces
- Tigers will have a Do-at-Home Project following Meeting 1 for which they will create their own constellations and name them (requirement 4).
- Read the Sky Is the Limit adventure in the *Tiger Handbook*.

## GATHERING

Play Quattro Tic-Tac-Toe. Quattro is played just like regular tic-tac-toe, but players are working for four in a row. When a player gets four in a straight row, diagonal row, or four that form a box (two in one row and two in the next), he wins. (See Meeting 1 Resources for the Quattro game board to duplicate.)

## OPENING

- Conduct a flag ceremony of your choosing that includes the Pledge of Allegiance and, as appropriate, the Scout Oath and Scout Law.
- Form a circle outdoors so everyone can look up toward the moon. Perform a flag salute while facing the moon. Explain to the Tigers that this is acceptable, as astronaut and Eagle Scout Neil Armstrong placed a flag on the moon. Follow the flag ceremony by sharing that both Armstrong, who was the first man to walk on the moon, and Charles Duke Jr., who walked on the moon a few years later, earned their Eagle Scout awards with the Boy Scouts of America! Challenge the boys to return next week with an interesting fact they learned about an astronaut who was a Scout as a boy (requirement 7). One resource is available here: [www.scouting.org/filestore/pdf/210-558\\_WB.pdf](http://www.scouting.org/filestore/pdf/210-558_WB.pdf).

## TALK TIME

- Carry out business items for the den.
- In this adventure, we will be talking about the sky and what we might see while observing it at night. Give each Tiger an opportunity to tell you one object he might see as he looks into the night sky. Tell how to find the North Star and how this star was used by travelers long ago to navigate. Share pictures of constellations, stars, and other objects that are found in the night sky.

## ACTIVITIES

### ◆ Activity 1: Moon Rock Hunt

Divide the den into teams. Scatter the “moon rocks” you prepared in inconspicuous corners of a designated area. When Tigers find one of the rocks, they must pick it up with a pair of metal tongs. The team that finds the most rocks in a set number of minutes wins.

## ◆ Activity 2: Constellation Match

Make a concentration card game of constellation pictures. Mount pictures of constellations on at least 12 4-by-6-inch index cards. Make an identical set, so that you have at least 24 cards. Shuffle the deck and lay it face down on a tabletop. Each boy tries to find a match by turning over two cards at a time. Each boy who gets a match gets a second turn.

## ◆ Activity 3: Create a Star Tie Slide

**Option 1:** Pour plaster of paris into a star-shaped candy mold (available at most craft stores), and attach a chenille stem or a 2-inch piece of PVC pipe on the back while the plaster is still wet. Paint or decorate with markers, adding glitter as desired.

**Option 2:** Provide each Tiger with a precut cardboard or wood star (available at most craft stores). Decorate with paint, markers, glitter, and stickers. Then use glue to attach a chenille stem or 2-inch length of PVC to the back.

## ◆ Activity 4: Star Songs

Learn a song about the stars (see Meeting 1 Resources for options). Be prepared to perform your song at the next pack meeting.

## CLOSING

- Have each boy share one new thing he learned at the meeting.



### Do-at-Home Project Reminder:

Tell Tigers that they will be creating their own constellations at home before the next meeting (requirement 4). Tigers should draw a picture of the constellation, give it a name, and be ready to share about their constellations with the den.

## AFTER THE MEETING

- Work together to clean up the meeting place.
- Serve refreshments, if desired.

# MEETING 1 RESOURCES

## SONGS

### IN THE NIGHT SKY

(Tune: "Alouette")

Flying saucers, planets, stars, and space junk,  
Flying, streaming, through the universe.

Looking in the sky at night  
Watching space ships making flight.

Sky at night,  
Making flight,  
Ohhhhhhh.

Flying saucers, planets, stars, and space junk,  
What can you see in the big night sky?

Sky at night,  
Making flight,  
Ohhhhhhh.

### OUT IN SPACE

(Tune: "Row, Row, Row Your Boat")

Space junk, meteors,  
Soaring through the sky,  
What a sight for all to see,  
In the sky so high!

# Quattro Game Board

(FOUR-IN-A-ROW TIC-TAC-TOE)





# Constellation and Star Pattern Game Cards



Big Dipper



Big Dipper



Pegasus



Pegasus



Little Dipper



Little Dipper



Orion



Orion



Cassiopeia



Cassiopeia



Boötes



Boötes



Cepheus



Cepheus



Lyra



Lyra

# MEETING 2 PLAN (Night Hike)

## PREPARATION AND MATERIALS NEEDED

- U.S. and den or pack flags
- Needed for night hike: flashlights for each Tiger and his adult partner; knowledge of two constellations—where to find them in the night sky and the origin of their names
- Items for Requirement 5 (see below)
- Telescope or binoculars for viewing the stars
- Materials for Activity 3: kitchen gloves for each Tiger, 6 large pairs of nuts and bolts, 1 pail with water
- Flier to give to Tigers and adult partners with the location, date, and time of the upcoming den outing
- Prepare a thank-you card that Tigers can sign for the den outing tour guide.

## GATHERING

- Have beanbags, jump ropes, and rubber balls available for Tiger astronauts to “train” as they gather.
- Set up stations for the boys that include short direction cards. For instance, they may jump rope five times or toss a beanbag over their head and catch it.

## OPENING

- Conduct a flag ceremony of your choosing that includes the Pledge of Allegiance and, as appropriate, the Scout Oath and Scout Law.

## TALK TIME

- Carry out business items for the den.
- Allow time for Tigers to share about astronauts they have learned about (requirement 7).

## ACTIVITIES

### ◆ Activity 1: Create a Homemade Constellation (Requirement 5)

- For Option 1, each Tiger will need a small metal coffee can that has been washed out and has no sharp edges; a marker; a small flashlight or click light; large nails; a hammer; safety goggles; and lightweight gloves (e.g., gardening gloves).
- If Option 2 is chosen, each Tiger will need the marker, the flashlight or click light, the lightweight gloves, and a wide-mouth jar (plastic is preferred). Also needed are a disposable cake pan or heavy-duty aluminum foil; something to punch holes in the aluminum (such as a safety pin); and a pair of scissors. The jar needs to be wide enough to fit the light inside. A pickle jar works well.

**Option 1:** Turn the can so the uncut end faces up. A Tiger chooses any constellation he wants from the patterns in Meeting 2 Resources, and uses a marker to mark the stars of the constellation on the lid of the can. The adult partner supervises and helps the Tiger hammer each star point to make a hole. Remind Tigers to wear safety goggles while using the tools. When the holes are made, write the name of the constellation on the side of the can. Put the lighted flashlight or click light in the can and let it shine on a flat surface.

**Option 2:** Wearing the lightweight gloves and using the scissors, the Tiger cuts a strip of the cake pan or foil to be the same height as the jar and long enough to fit around the inside. He smooths out the aluminum on a table and uses the marker to draw one of the constellation patterns, marking dots for the stars and poking holes in the dots with the safety pin—being careful not to stick himself. Smaller holes can be added as desired to represent surrounding stars. The aluminum can then be rolled and slid into the jar to fit in place. Now put the light inside and take the jar into a dark room to see the night sky!



### ◆ Activity 2: Night Hike (Requirements 1, 2, and 3)

- With their adult partners, have Tigers take a night hike in a safe, flat area. Stop several times during the hike, look at the sky, and listen to the night sounds.
- Learn the different parts of a telescope or binoculars and how to focus the device.
- Using pictures of constellations, locate two of them in the sky.
- Share with your den what you saw and heard on the hike.
- Make sure Tigers are prepared to tell the den about the two constellations they observe and how each constellation got its name.

### ◆ Activity 3: Space Station Repairs

If time permits, complete “space station repairs.” Give each Tiger a pair of kitchen gloves. Drop six large pairs of nuts and bolts into a pail of water. Each player has to try to screw the nuts and bolts together underwater. The one who finishes the most sets in a specified amount of time wins.

### ◆ Activity 4: Song Practice

If time permits, practice your song selection for the next pack meeting.

## CLOSING

- Ask the boys to share the names they gave to their constellations and why they chose those names.
- Ask each Tiger to share his constellation with another Tiger.
- Give Tigers time to share what they learned or liked best about this “starry” meeting.
- Have everyone sign the thank-you card for the upcoming outing.
- Hand out a flier you have made with the outing location, time, and date. On the flier, remind the Tigers and their adult partners to write down a few questions they can ask about astronomy and people who have jobs in that field.



### Do-at-Home Project Reminder:

The next meeting will be an outing to a planetarium, observatory, science museum, etc., or a visit with an astronomy expert (requirement 8). Ahead of the outing, Tigers should prepare any questions they would like to ask.

## AFTER THE MEETING

- Serve refreshments, if desired.
- Record completion of requirements 1, 2, 3, 4, 5, and 7.
- Work together to clean up the meeting place.

# MEETING 2 RESOURCES

## PATTERNS FOR HOMEMADE CONSTELLATIONS AND STAR PATTERNS

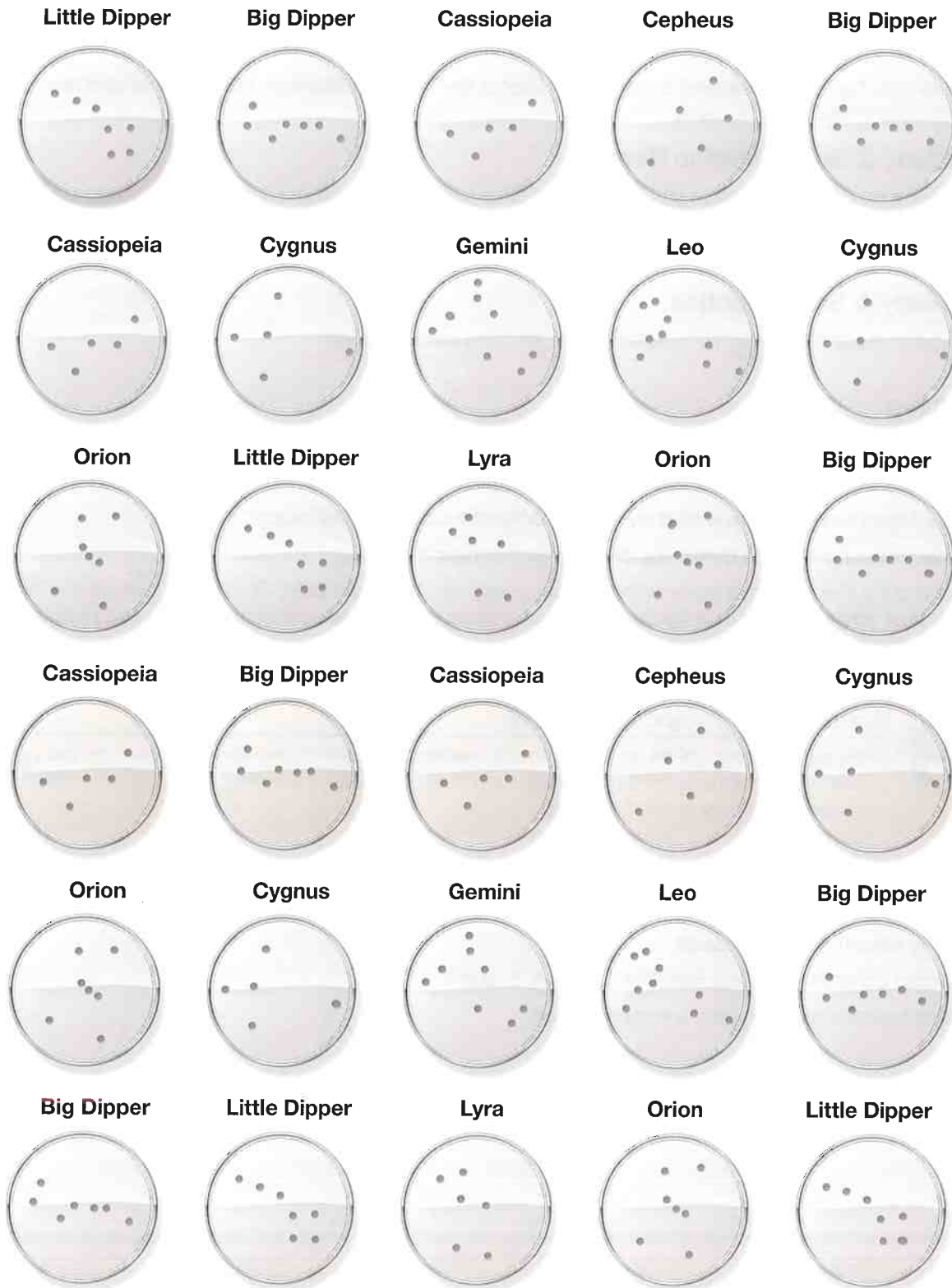

## BINOCULARS AND TELESCOPES

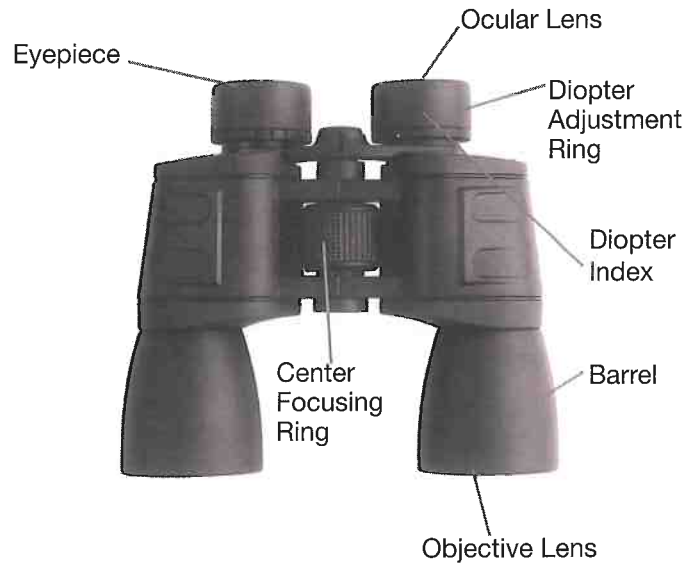

1. Finderscope
2. Focuser
3. Eyepiece
4. Release Control for Mount
5. Mount Base or Mounting Plate
6. Outer Tripod Leg
7. Tripod Leg Extension
8. Tripod Support Brace
9. Tripod Leg Clamp
10. Mount Axis
11. Mount
12. Mirror Cell—Primary
13. Telescope Tube
14. Finderscope Eyepiece
15. Finderscope Bracket

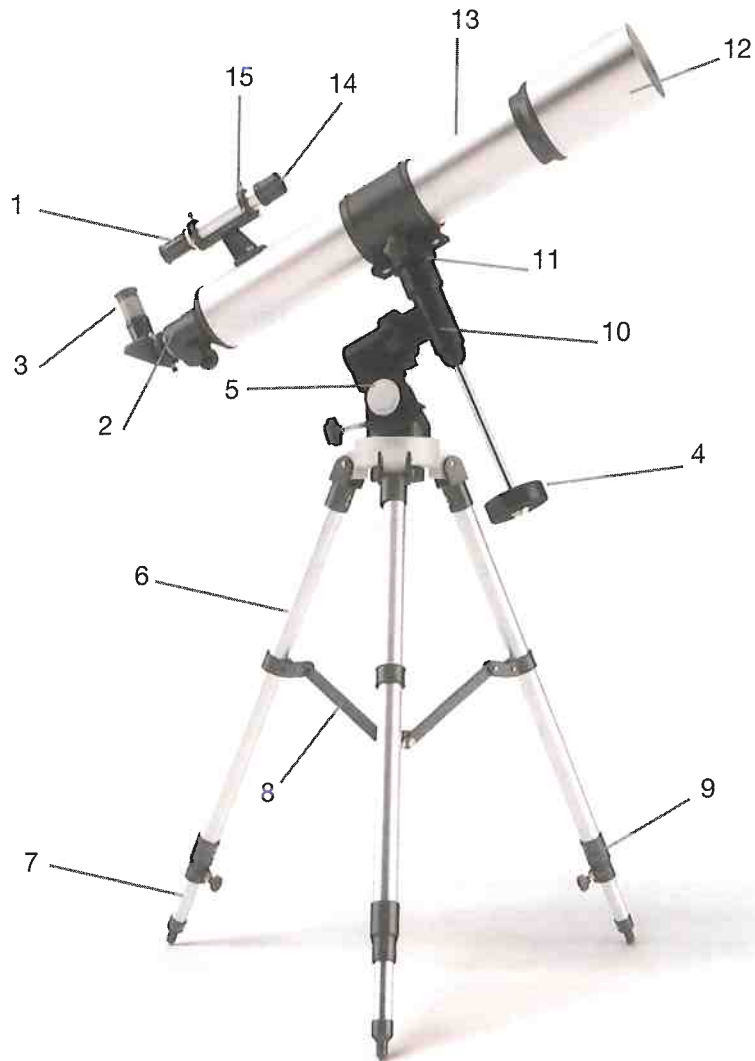

# MEETING 3 PLAN (Den Outing)

## PREPARATION AND MATERIALS NEEDED

- Make arrangements ahead of time to visit a planetarium, science museum, observatory, or college science lab that teaches astronomy. You might also choose to invite an astronomy club or stargazers club to visit the den meeting. Plan to provide hands-on opportunities for the boys, such as observing and focusing a telescope, observing a night sky demonstration, or participating in a science project.
- Unit den leader should have in possession (if required by local council practices) the tour and activity plan, signed activity consent forms, and a copy of the *Guide to Safe Scouting*. Confirm that all adult partners have the date and time, meeting place, and directions for the outing.

## GATHERING

- Review expected behavior with the Tigers.
- Set up and enforce the buddy system.
- Discuss ahead of time appropriate questions that may be asked.

## OPENING

- Say the Pledge of Allegiance and, as appropriate, the Scout Oath and Scout Law. If the den does not have a United States flag on the outing, ask one Scout to display the flag on his uniform for the group.

## TALK TIME

- Carry out business items for the den.

## ACTIVITIES

### ◆ Activity 1: Conduct the Visit (Requirements 6 and 8)

Have each boy ask the questions he prepared about the night sky or about jobs that are related to astronomy.

## CLOSING

- Present the tour guides with thank-you cards prepared ahead of time.
- If time permits, gather the Tigers and review what they learned.

## AFTER THE MEETING

- Provide refreshments, if desired.
- Record completion of requirements 6 and 8.
- Make sure everything is cleaned up.

Upon completion of the Sky Is the Limit adventure, your Tiger will have earned the adventure loop shown here. Make sure they are recognized for their completion by presenting the adventure loops, to be worn on their belts, as soon as possible according to your pack's tradition.





# STORIES IN SHAPES



## RATIONALE FOR ADVENTURE

This adventure will engage the boys' imaginations and creativity as they work on some simple art projects that do not require traditional art skills.

## TAKEAWAYS FOR CUB SCOUTS

- Building listening skills
- Encouraging creativity
- Improving communication with peers
- A Scout is clean. 

*Tiger Handbook, page 204*

## ADVENTURE REQUIREMENTS

1. Visit an art gallery or a museum, explore an art website, or visit your library. Do each of the following:
  - a. Look at pictures of some abstract art with your den or family. Decide what you like about the art, and share your ideas with the other Tigers.
  - b. Create an art piece.
2. Do the following:
  - a. Draw or create an art piece using shapes.
  - b. Use tangrams to create shapes.

### NOTES TO DEN LEADER

This elective allows the boys to be creative and artistic, without requiring particular drawing abilities. While some lead time is necessary to find suitable artwork to show the boys, knowledge of the "art world" is not really a prerequisite. Good resources are likely available through the local school system or arts council, or perhaps in a nearby art gallery.

Meeting 3 is an outing to an art museum or other location where Tigers can view abstract art. Be sure to contact the museum in advance to plan for a tour. In advance of the outing, the leader will need to make arrangements with the outing location and confirm the outing plan with families, including transportation and any additional items they need to bring. Make sure a tour and activity plan has been submitted, if required, and activity consent forms are distributed, signed, and collected.

See the Appendix for optional den meeting activities, including openings, gatherings, and closings.

## MEETING 1 PLAN

### PREPARATION AND MATERIALS NEEDED

- U.S. and den flags
- Opening: colored masking tape or yarn in red, yellow, and blue
- Materials for the color mixing activity during the Gathering: red, yellow, and blue washable paints or markers. If you are using paint, you will also need cotton swabs or small paintbrushes, small cups for water to wash out brushes, paper plates or paper, and newspaper to cover the area where the colors are being mixed.

- Have enough small slips of paper to give one to each Tiger. On each slip, draw either a red circle, yellow square, or blue triangle.
- Plenty of paper to be used for art expression
- Markers, watercolors and brushes, crayons, or colored pencils—enough for all the Tigers to use
- Abstract artwork examples from such artists as Jackson Pollock, Pablo Picasso, Marc Chagall, and Georgia O’Keeffe
- Two music pieces that sound very different—for example, a classical piece and a hard rock song

## GATHERING

All colors are made from just three main colors, called primary colors: red, yellow, and blue. When you mix red and yellow, you get orange. Yellow and blue make green, and blue and red make purple. Orange, green, and purple are called secondary colors.

- Organize a space where the Tigers and their partners can work with the primary colors—red, yellow, and blue—to create secondary colors. Use watercolors or washable, colored markers. Write these questions on poster-size sheets of paper and post them around the space:
  - Can you find a way to make orange, green, and purple using these three colors?
  - Create your own color! What colors did you use?
  - Create a picture using your favorite color or colors.
- Give each Tiger a slip of paper with a red circle, yellow square, or blue triangle on it to use for the opening.

## OPENING

- Conduct a flag ceremony of your choosing that includes the Pledge of Allegiance and, as appropriate, the Scout Oath and Scout Law.
- Use colored masking tape or yarn to mark off a large red circle, a large yellow square, and a large blue triangle on the floor. Based on the colors the boys received, gather each of them with their partners into the circle, square, or triangle. Ask one of the groups to lead the Pledge of Allegiance. Another group will lead the Scout Oath, and the third group will lead the Scout Law.

## TALK TIME

- Carry out business items for the den
- Invite Tigers to show off the pictures they created during the Gathering activity. Be ready to ask questions about each picture to help Tigers understand how colors and shapes can convey a meaning or feeling. As each Tiger finishes, post his picture on the wall, creating a collage of colors and shapes. Point out to the Tigers that the final collage tells many stories.
- Introduce the Stories in Shapes adventure to the den. Say: *Let’s look at other pieces of art to find what stories they tell us!*

## ACTIVITIES

### ◆ Activity 1: Art as Communication (Requirement 1a)

**Materials:** Several pictures showing abstract works of art; online sources may include [www.moma.org](http://www.moma.org) and [www.Americanart.si.edu](http://www.Americanart.si.edu).

#### Instructions:

1. If you have found several pictures of abstract art, divide the Tigers into groups and give each group a picture.
2. Ask the groups to spend a few minutes carefully observing everything they can in their pictures, taking into consideration the use of colors, shapes, and proportions.
3. Have the Tigers in each group create an original story about the artwork. Invite the adult partners to help them.

4. Invite each group to tell their story to the rest of the den. Ask some reflection questions to make sure these ideas have been covered:
  - a. Were there any words used in these art pieces?
  - b. How did you know what they were telling you?
  - c. Do colors sometimes suggest certain feelings? Which colors? What feelings?
  - d. How is art considered a means of communication if there are no words?

### ◆ **Activity 2: Express Words With Art**

1. Create a list of words for Tigers to draw or paint. Use lots of action words and descriptive adjectives. Words such as *running*, *splashing*, *bouncing*, *laughing*, *angry*, *happy*, *sad*, *quickly*, *dangerous*, *good*, and *bad* are suitable.
2. Distribute enough small pieces of paper and washable markers or paint for each Tiger to use. A Tiger may draw or paint more than one word. Ask each adult partner to keep track of which drawing goes with which word.
3. Have the boys describe why they chose the colors or shapes they did for different words. Be sure to ask each Tiger to explain at least one of his word creations. Allow everyone to use their imaginations and avoid feeding ideas to them: If you, as the leader, say that “anger” looks like a jagged red line, so will each boy.

### ◆ **Activity 3: Create an Original Piece of Art (Requirement 1b)**

1. Tell the Tigers that, as a final activity for the meeting, they will draw or paint their own original piece of art, using music to help them create their story. Make sure each boy has enough space for his paper. Give each one a large sheet of paper (at least 9 by 12 inches), and check that he has enough paint, markers, crayons, or colored pencils. Tell Tigers that they need to wait until they hear the music to start drawing or painting.
2. Play two very different musical pieces. The first piece might be classical, such as Beethoven, Brahms, Haydn, Mozart, or any other classical composer. Some specific song options are: Beethoven’s Fifth Symphony, Brahms’ First Symphony, Mozart’s Symphony No. 40, Haydn’s Surprise Symphony, or Tchaikovsky’s *Romeo and Juliet*.
3. After at least five minutes, change the music to something very different—maybe some hard rock, country, bluegrass, hip-hop, swing band, or any other music that you find. (Be sure to check the lyrics of any song you choose to make sure they are appropriate for this age.) Encourage the boys to use different colors and shapes depending on what they hear. For example, they are likely to use faster strokes for faster music and long, slow strokes for slower music.
4. When the music ends, Tigers are to finish their creations.
5. If paint was used, allow for hand-washing!

## **CLOSING**

- Invite each Tiger and adult partner to stroll around the room, observing the other boys’ artwork.
- Call for the red circle, yellow square, and blue triangle groups to return to their marks on the floor.
- Have each group recite the Cub Scout motto in turn when you count to three.

## **AFTER THE MEETING**

- Serve refreshments, if desired.
- Record completion of requirements 1a and 1b.
- Work together to clean up the meeting place.
- Prepare thank-you notes for the Tigers to sign at the next meeting.

# MEETING 2 PLAN

## PREPARATION AND MATERIALS NEEDED

- U.S. and den flags
- Make a copy of a tangram puzzle for each boy (see Meeting 2 Resources for template).
- Markers, crayons, or colored pencils for each Tiger to use.
- Have enough paper on hand for each boy to use when drawing shapes.
- Provide scissors for each boy, or enough for them to easily share. Include a pair of left-handed scissors, if those might be needed.
- Print out sample silhouettes of tangram puzzles (see Meeting 2 Resources).
- Provide zippered plastic bags for each Tiger to store his tangram pieces.
- Write instructions on cards or note paper for specific shape-drawing activities. Suggested instructions:
  - Use between 3 and 15 circles, big or small, to draw something
  - Use between 4 and 16 squares, big or small
  - Use 3 to 15 circles and triangles, any size
  - Use 3 to 16 circles, squares, and triangles
  - Use 3 to 20 circles, squares, triangles, and rectangles

Feel free to revise these instructions based on the needs of the Tigers in your den.

## GATHERING

Gather materials for the boys to color their tangram puzzles, using up to seven colors across the puzzle segments. Note: Paint will not work because it will not dry in time for the Tigers to use the tangrams later in the meeting.

## OPENING

- Conduct a flag ceremony of your choosing that includes the Pledge of Allegiance and, as appropriate, the Scout Oath and Scout Law.
- Optional Opening: Call the Tigers to stand together in a square and recite the Pledge of Allegiance and the Scout Oath. Have each Tiger greet his neighbor using a hand shape greeting. Start the greeting chain by showing the den one half of a shape using your hands and fingers. Ask the person next to you to make the same shape with his or her hands and fingers, thus making a complete shape! As each boy makes his shape with someone else, he tells the other Tiger something fun that he did during the past week.

## TALK TIME

- Carry out business items for the den.
- Announce the outing plans for the next meeting. Be sure that everyone knows the name of the museum or art gallery and the address. Remind the Tigers to arrive in uniform and briefly tell them what they will see during the visit, if you have this information.



## ACTIVITIES

### ◆ Activity 1: Group Shape Art (Requirement 2a)

1. Ask the Tigers to form a circle (or sit around a table). Distribute one sheet of paper to two different boys.
2. Each boy starts by drawing one shape on the piece of paper, then passes it to his neighbor.
3. The next boy adds a shape and so on until everyone has had the chance to draw one. Adult partners can also be included in this activity.
4. When everyone has had a turn, it's time to discover what all the shapes together look like! Then the Tigers can give the picture a name or make up a story about it.

### ◆ Activity 2: Individual Shape Art (Requirement 2a)

1. Distribute paper to each Tiger.
2. Have the boys and their partners talk about various, simple geometric shapes.
3. Let each boy draw one shape and then have his partner decide on a simple picture they can draw together, using multiples of the same shape or similar shapes in various sizes. When they finish this, let the partner draw a shape and have the Tiger decide what to create from it.
4. Give each Tiger one of the prewritten instruction cards, and let him draw a shape based on those instructions.
5. Allow a moment for each Tiger to share his creative work of art!

### ◆ Activity 3: Tangram Fun! (Requirement 2b)

1. Once the shape project is complete, have each Tiger return to his tangram puzzle, cut apart the segments, and collect them in his bag.
2. Allow Tigers to use their imaginations to create forms with the tangram pieces.
3. To help them, share the silhouettes of possible tangram forms.

## CLOSING

- Hold a brief reflection time for Tigers to talk about what they enjoyed most during the activities and what they found challenging or surprising.
- Confirm that transportation and other plans are in place for the den outing in Meeting 3.
- Have Tigers sign thank-you notes for the upcoming den outing.

## AFTER THE MEETING

- Serve refreshments, if desired.
- Record completion of requirements 2a and 2b.
- Work together to clean up all art supplies from the meeting place.

## MEETING 2 RESOURCES

### TANGRAM

The tangram is an ancient Chinese puzzle. A tangram always has a total of seven shapes: two large triangles, one medium triangle, two small triangles, one parallelogram, and one square. One challenge is to put the seven pieces together to form a big square.

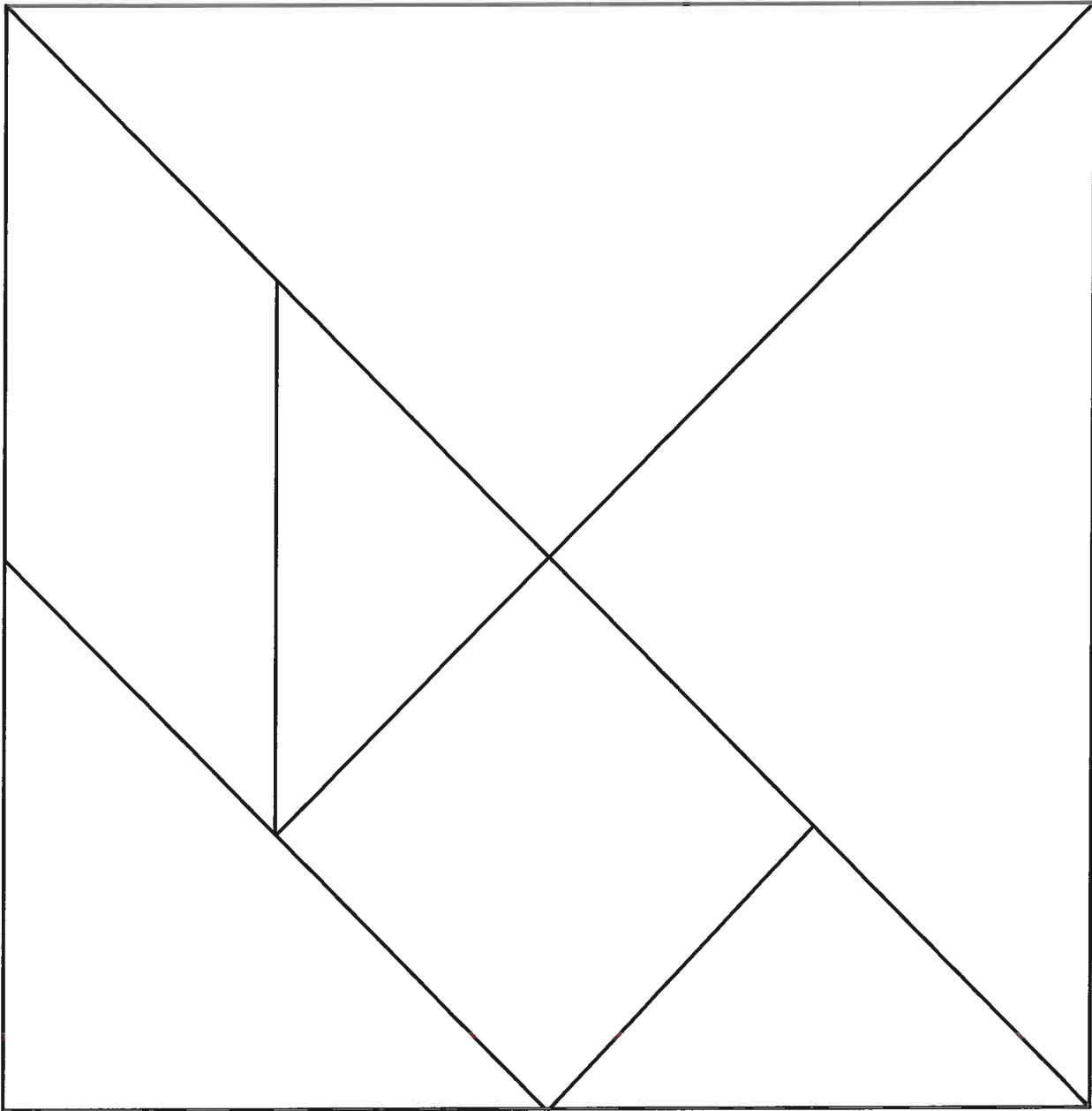

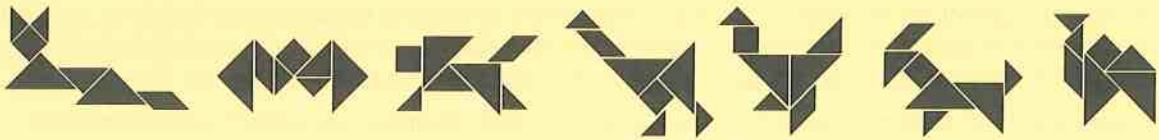
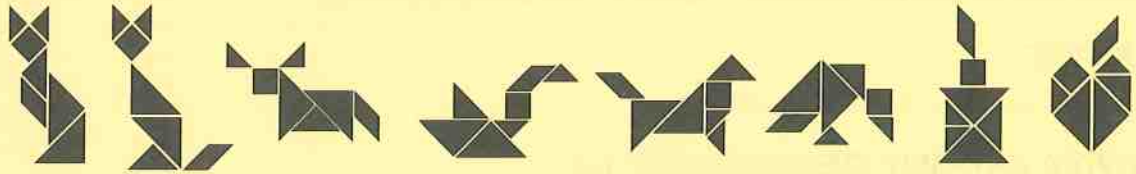
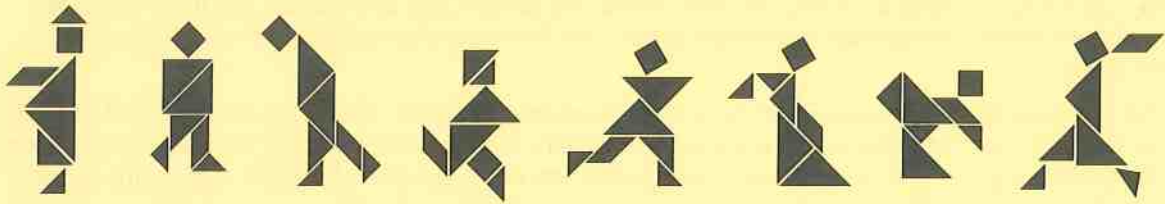
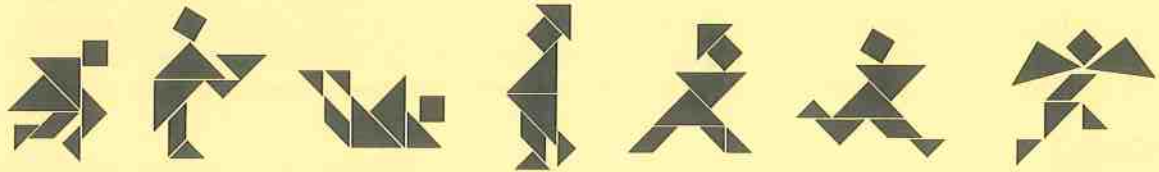
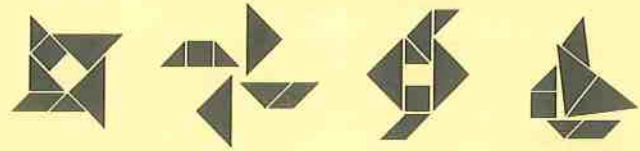
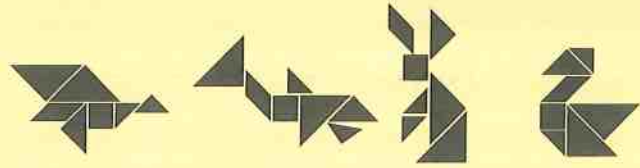
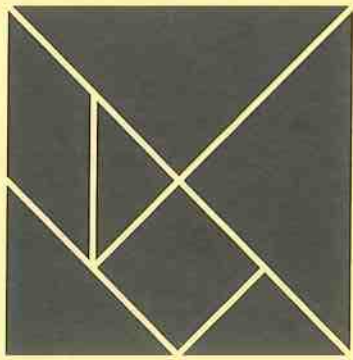

# MEETING 3 PLAN (Den Outing)

## PREPARATION AND MATERIALS NEEDED

- Confirm with the museum or gallery any plans for a tour guide and rules the group must follow.
- If possible, gather some background information on the type of art the Tigers will observe, so you can help them understand it and ask questions.
- Unit den leader should have in possession (if required by local council practices) the tour and activity plan, signed activity consent forms, and a copy of the *Guide to Safe Scouting*.

## GATHERING

While waiting for everyone to arrive, play a game such as I Spy or I'm Thinking of a Color. In the latter game, you focus on an object without letting the Tigers know what it is—you only give them a color—and they ask questions to try to guess the object. Questions might be "Is it small?" or "Is it large?" or "Is it in this room?" The Tiger who guesses correctly can be the next one to think of a color.

## OPENING

- Say the Pledge of Allegiance and, as appropriate, the Scout Oath and Scout Law. If the den does not have a United States flag on the outing, ask one Scout to display the flag on his uniform for the group.
- This is a good time to remind Tigers to be courteous and obedient. It will also be important to explain the "ground rules" of being inside a museum or gallery. Check with the facility to make sure you know those rules (e.g., do not run, stay with your partner, do not touch the artwork or lean on the display cases). Also go over the procedure to follow in case someone gets lost.

## TALK TIME

- Carry out business items for the den.

## ACTIVITY: ART VISIT (REQUIREMENT 1a)

- Visit an art gallery, art museum, school art department, or another place where there is art to observe. If someone on staff there or a guest will be leading the visit, be sure to introduce that person to the den. Let the person know of any special needs and anticipated questions from the Tigers.
- Tigers and their adult partners will move through the area. Partners will guide Tigers to observe different art pieces and talk about their observations.
- As time allows, give each Tiger and his partner time on their own to find the art they enjoy most.

## CLOSING

- Come together as a den and thank the person in charge of the tour.
- Ask each Tiger to tell you his favorite piece of art and why it was his favorite.

## AFTER THE MEETING

- Serve refreshments, if allowed.
- Record completion of requirement 1a, if not previously completed.

Upon completion of the Stories in Shapes adventure, your Tigers will have earned the adventure loop shown here. Make sure they are recognized for their completion by presenting the adventure loops, to be worn on their belts, as soon as possible according to your pack's tradition.





## RATIONALE FOR ADVENTURE

This adventure will help boys learn about different types of games, whether individual games, team games, or initiative games. As an elective, it provides them with the chance to explore games that are new to them and to use their imaginations. It also encourages their willingness and ability to work and talk in the group.

## TAKEAWAYS FOR CUB SCOUTS

- Trying individual versus team games
- Experiencing winning and losing
- Developing sportsmanship
- Team building
- Using imagination and creating games
- A Scout is kind. 

## ADVENTURE REQUIREMENTS

*Tiger Handbook, page 212*

Complete 1–3 and one from 4–6.

1. Play at least two different games by yourself; one may be a video game.
2. Play a board game or another inside game with one or more members of your den.
3. Play a problem-solving game with your den.
4. With your parent's or guardian's permission:
  - a. Play a video game with family members in a family tournament.
  - b. List at least three tips that would help someone who was learning how to play your favorite video game.
  - c. Play an appropriate video game with a friend for 30 minutes.
5. With other members of your den, invent a game, OR change the rules of a game you know, and play the game.
6. Play a team game with your den.

### NOTES TO DEN LEADER

If Tigers choose the option of requirement 4, they should complete that requirement between Meeting 1 and Meeting 2. Adult partners should help Tigers choose an appropriate video game and confirm that the Tiger's friend has permission to play.

This adventure does not include plans for a den outing. If a den outing is desired, the leader may plan to hold one of the meetings at a location suitable for playing games. All event coordination and necessary tour and activity plans would need to be in place in advance, depending on the location selected.

See the Appendix for optional den meeting activities, including openings, gatherings, and closings.

# MEETING 1 PLAN

## PREPARATION AND MATERIALS NEEDED

- U.S. and den flags
- Writing materials for Gathering
- Various games that are suitable for play by individuals are needed. For example, puzzles, connect-the-dots, and ball-in-cup are all simple, one-person games. Video games may be suitable, although boys may need to bring their own portable game devices. Otherwise, a single game console could distract everyone's attention.
- Board games for two or more persons playing as individuals, such as checkers
- For the opening: Poster boards with letters spelling AMERICA on front and the corresponding line on back in large print, so it can be easily read
- Materials needed for T-shirt relay: 1 extra-large T-shirt for each team. You will also need a judge for each team.
- Read the Tiger-iffic! adventure in the *Tiger Handbook*.

## GATHERING

Have each Tiger and his adult partner prepare a list of his favorite and least favorite games. Include those that he likes to watch and those he likes to play. Or have each boy (with his partner's help) write down as many sports or teams as he can, or match the names of various teams with the mascot or the sport played. (Don't forget teams in the local community.)

## OPENING

- Conduct a flag ceremony of your choosing that includes the Pledge of Allegiance and, as appropriate, the Scout Oath and Scout Law.
- Optional Opening: "**America**"

**Equipment:** Poster board, flag, and flag stand. Print letters spelling AMERICA on the front of the poster boards and the lines to be read on the back in LARGE print.

Each Tiger displays and shouts out his letter. The boy or his adult partner can recite the line:

**A** is for **ATHLETES** who do their best.

**M** is for **MUSCLE** building, putting us to the test.

**E** is for **EXERCISE**, building strength and brawn.

**R** is for **RUNNING**—just look, then we're gone.

**I** is for **INDIVIDUALS** who always try to achieve.

**C** is for **COURAGE** to do and believe.

**A** is for **ACTIVE**, and active we'll be.

**ALL:** Proud to live in America, the home of the free.

Then recite the Pledge of Allegiance and the Scout Law.

## TALK TIME

- Carry out business items for the den.
- Introduce the Tiger-iffic! adventure to the den. Build interest by describing the goals of the adventure and some of the activities that are planned.
- Introduce the games to be played during the meeting.

## ACTIVITIES

### ◆ Activity 1: Individual Games (Requirement 1)

Have the Tigers play individual games for a short time, and then lead a discussion of what they liked about those games or why they chose the games they did. Each Tiger should play at least two individual games.

**Skunk Sniff:** Skunk Sniff is a game where Tigers try to guess and match the smells inside paper or plastic bags. It requires some setup. Prepare several small bags, each marked on the outside with a number. Place in each bag a little piece of sponge that holds the scent of an item or place the actual item wrapped up in a paper towel so the distinctive odor of each can be detected. (Paper bags work better if the substance can be readily seen through plastic.) Put each substance in two different bags; then Tigers try to find the bags that match. Items like lemon juice, soap, perfume, vinegar, spices, bananas, or burnt toast work well. Be sure to avoid potentially dangerous items such as most cleaning supplies.

**Memory:** Memory games are readily available for purchase or can be created using any ordinary deck of cards or combination of decks. Depending on the type of cards used, players can either match identical cards or, perhaps, find two black (or red) cards of the same value.

**Musical Chairs:** This is another fun individual game the Tigers will enjoy. You can use recorded music or you can simply hum a tune and clap. Put out enough chairs back to back so every Scout has a seat. Start the music. While the music is playing, Tigers should walk around the chairs, in the same direction. While they are walking and the music is playing, take one chair away. Once the music stops, Tigers must find a chair to sit in. Whoever is left standing is out of the game. The winner is the Tiger sitting in the last chair.

### ◆ Activity 2: Team Game (Requirement 6)

#### T-Shirt Relay Game

**Materials:** 1 extra-large T-shirt for each team; 1 judge for each team

**Notes:** This game emphasizes teamwork, and everyone is involved the whole time. Boys who wear eyeglasses should remove them before playing this game.

The judge should make sure the shirt is pulled all the way down on each Tiger and no shortcuts are taken in the heat of competition.

#### Instructions:

1. Divide into two to four teams.
2. Have teams line up single file.
3. Give the shirt to the first Tiger in each line.
4. On the "Go" signal, the first Tiger puts the shirt on and then holds hands with the next Tiger in line, facing him.
5. All the others on the team then pull the shirt off the first Tiger and put it on the second Tiger. Then Tiger 2 turns, holds hands with Tiger 3, and so on. Teams need to have the same number of players; otherwise, some will need to wear the shirt twice.

## CLOSING

- Have the boys share some thoughts about the games they played. Then let them decide what games they will play at the next meeting. Invite them to bring their favorite board games.



### Do-at-Home Project Reminder:

Tigers can bring their favorite board games to the next meeting to share with the den. Also, if Tigers are choosing the option of requirement 4, they should make plans with their families to complete it at home.

## AFTER THE MEETING

- Record completion of requirements 1 and 6.
- Work together to clean up the meeting place.

# MEETING 2 PLAN

## PREPARATION AND MATERIALS NEEDED

- U.S. and den flags
- For Gathering: assorted game equipment such as balls or flying discs; if indoors, sponge balls or bean bags
- Board games (Encourage Scouts ahead of time to bring their favorite board game to the meeting. You may wish to bring games as well to ensure that there are enough for all boys to play.)
- Materials for any other games that will be played during the meeting, including the problem-solving game (See the options under Activities below to determine materials needed. Prepare questions to lead discussion/reflection after the game.)

## GATHERING

- Have some game equipment available that will make Tigers want to play together. Balls or flying discs, for example, are good choices.
- The den leader might suggest a simple outdoor game such as kickball or an indoor game such as bowling. However, find a way to change the game; perhaps use something else as the ball and throw instead of kick, or have something else to knock down instead of 10 pins (requirement 5).
- Ideally, the same equipment might transfer to the problem-solving game to be played later in the meeting. If the games are not decided beforehand, share some game ideas as the boys arrive, and have them talk with their adult partners to decide then so the start of the meeting won't be delayed.

## OPENING

- Conduct a flag ceremony of your choosing that includes the Pledge of Allegiance and, as appropriate, the Scout Oath and Scout Law.
- Give a group Tiger roar.

## TALK TIME

- Carry out business items for the den.
- Find out what activities were completed at home from requirements 1 and 4. Give each Tiger time to share about this with the den.
- Talk with the Tigers about how good sportsmanship relates to the Scout Law. A Scout is courteous and kind, and he should always remember that being a good sport, win or lose, allows him to live by the Scout Law. Keep the conversation lively and appropriate to a Tiger age level, focusing on the most important points.



## ACTIVITIES

### ◆ Activity 1: Problem-Solving Game (Requirement 3)

Play a short team-based game appropriate for the meeting setting and the range of skills in the den. Then play a problem-solving game that is also suitable AND for which you are comfortable leading a discussion/reflection. If possible, let the boys choose the games that will be played at this meeting. Develop questions that will help them understand:

- The feelings that come with winning and losing
- The choice of playing by oneself as opposed to playing with others
- The value of courtesy and sportsmanship

#### NOTE TO DEN LEADER

Problem-solving games in Scouting are also referred to as team-building games and initiative games. Remember that the den will include boys of different skill levels and with different interests. Some Tigers may even need extra help (from their partners) or extra time.

**Team-Building or Problem-Solving Game:** The players—all Tigers or all partners—are covered with a large blanket. The object is to move as a unit and follow directions (turn right, back up, etc.) so they can maneuver around or over a variety of obstacles.

**Magnetic Hike:** Divide the Tigers into relay teams and then pair off the players in each team. The pairs line up, one player facing the other with the toes of their shoes touching and arms at their sides. On “Go,” the first pair in line moves toward a marker trying to keep their toes touching at all times. They walk around the marker and back to their team so the next pair can go. The first team to complete the course wins.

**Crabwalk Soccer:** Crabwalk soccer can be played indoors, if the space is large enough, or outdoors. Everyone must move in a crab position (on all fours, stomach up) and kick the ball while staying in that position.

**Balloon Toss:** Balloon toss is a simple game in which players sit in two lines facing each other with their feet touching. The leader drops a balloon, and the entire group must keep it from touching the ground without separating their feet. If you have enough players, see which of two teams can keep the balloon off the ground the longest. (Note: Most balloons contain latex, so be sure to check with adult partners before the meeting to confirm that no one in the den has a latex allergy.)

### ◆ Activity 2: Board Games (Requirement 2)

Play the board games the boys brought, dividing everyone into teams with one adult partner and at least two Tigers. After they play the game once, have them change the rules and play again; this gives them a way to complete requirement 5 if they weren’t able to create their own rules for a game during the Gathering.

## CLOSING

- Recite the Scout Law.
- Remind Tigers of ways their attitudes reflected the Scout Law when they played the board games and the problem-solving game.

## AFTER THE MEETING

- Record completion of requirements 2, 3, 4, and 5.
- Work together to clean up the meeting place.

Upon completion of the Tiger-iffic! adventure, your Tigers will have earned the adventure loop shown here. Make sure they are recognized for their completion by presenting the adventure loops, to be worn on their belts, as soon as possible according to your pack’s tradition.



# NOTES



# TIGER: SAFE AND SMART



## RATIONALE FOR ADVENTURE

In this adventure, Tigers will learn that a safe child is one who is aware of his or her surroundings and knows how to respond to danger.

## TAKEAWAYS FOR CUB SCOUTS

- Practice in problem solving
- Learning how to respond to danger
- Developing confidence
- A Scout is courteous, brave. 

## ADVENTURE REQUIREMENTS

*Tiger Handbook, page 226*

1. Do the following:
  - a. Memorize your address, and say it to your den leader or adult partner.
  - b. Memorize an emergency contact's phone number, and say it to your den leader or adult partner.
  - c. Take the 911 safety quiz.
2. Do the following:
  - a. Show you can "Stop, Drop, and Roll."
  - b. Show you know how to safely roll someone else in a blanket to put out a fire.
3. Make a fire escape map with your adult partner.
4. Explain your fire escape map, and try a practice fire drill at home.
5. Find the smoke detectors in your home. With the help of your adult partner, check the batteries.
6. Visit an emergency responder station, or have an emergency responder visit you.

### NOTES TO DEN LEADER

It is important to teach stranger awareness without creating an atmosphere of fear in your den. For further guidance in teaching safety to Tigers, visit the BSA's Youth Protection website: [www.scouting.org/bsayouthprotection.aspx](http://www.scouting.org/bsayouthprotection.aspx).

Before Meeting 2, ask the adult partners to consider creating a "safe word" with their Tigers. The safe word is one that only family members know, and it would come into play if a stranger approaches the child. Should a stranger suggest a parent had sent him or her to bring the child home, the child would ask the stranger for the safe word to know it was OK.

It is very important to teach safety as an empowerment tool and not to instill fear. An aware child can make and carry out a plan in an emergency. A frightened child may "shut down" and panic in an emergency.

Meeting 3 will be a den outing to a first-responder station. Possible locations include hospitals (if they have emergency flight vehicles), ambulance headquarters, police stations, and fire stations. Be sure to plan at least a month in advance. Provide Tigers and adult partners with the plans for the outing, and confirm that transportation has been arranged. Make sure a tour and activity plan has been submitted, if required, and activity consent forms are distributed, signed, and collected.

See the Appendix for optional den meeting activities, including openings, gatherings, and closings.

# MEETING 1 PLAN

## PREPARATION AND MATERIALS NEEDED

- U.S. and den flags
- Thank-you note or materials to make one
- Materials for activities: 911 quiz, cellphone number, house phone number
- Read the Tiger: Safe and Smart adventure in the *Tiger Handbook*.

## GATHERING

### Red Light Green Light

**Outside:** Have Tigers line up on one side of the yard. Assign one person to be the “stop light.” When he or she calls out, “Green light!” everyone can run forward. When he or she calls out, “Red light!” everyone stops.

**Inside:** Instead of running, have Tigers wiggle in place during “green light” and freeze during “red light.”

## OPENING

- Conduct a flag ceremony of your choosing that includes the Pledge of Allegiance and, as appropriate, the Scout Oath and Scout Law.

## TALK TIME

- Carry out business items for the den.
- Introduce the Tiger: Safe and Smart adventure to the den. Build interest by describing the goals of the adventure and some of the activities that are planned.
- Give each Tiger time to share information about his week. You might use a talking stick or other item to help moderate the time and encourage respect.
- Ask the Tigers to share what they know about 911.

## ACTIVITIES

### ◆ Activity 1: How to Call 911

- Show the Tigers both a cellphone and a home phone. Explain that if they are at home when an emergency occurs and there is a home phone, that’s the phone they should use because the address will pop up on the screen at the 911 call center.
- It is important to remember that they should not hang up the phone until responders arrive, and they should speak in a clear voice.
- Remind them that it can actually be a crime to call 911 as a joke.
- Explain the difference between an emergency that requires calling 911 and a problem that can be handled with an adult at home or school.
- Role-play situations where Tigers can call out, “Call 911” or “Not an emergency.” For example:
  - You cannot find your favorite game.
  - You smell smoke or gas in your house.
  - You need help to complete your science homework.
  - Someone in your family has fallen and cannot get up.

## ◆ **Activity 2: Learning Your Address and Phone Number (Requirements 1a and 1b)**

- Explain the importance of knowing your address and the phone numbers of people close to you.
- Have the Tigers work with their adult partners for a few minutes to see how much of the information they know and what they need to work on.

## ◆ **Activity 3: 911 Safety Quiz (Requirement 1c)**

- Create a quiz that includes yes/no questions similar to those found in the Tigers' handbooks.
- One option for delivering the quiz is as follows:
  - Create, type, and print the questions you select. Cut the questions into strips of paper.
  - Place the questions in an empty adhesive bandage box or other container representing a safety item.
  - Pull out the questions one at a time. Ask boys to share their answers, and then, as a group, confirm the best responses.
- Use the questions below or create additional questions appropriate to the needs of your den.
- Five to 10 questions would be ideal. Choose questions that are relevant to the boys in your den. For example:
  - When is it OK to call 911? (a person is unconscious, your buddy has broken a bone, a fire, etc.)
  - When should you NOT call 911? (lost toy, missing pet, angry with sibling, broken window, out of ice cream, scraped knee, etc.)
  - Should you whisper on the phone?
  - Should you use a clear, loud voice on the phone?
  - How long should you stay on the phone with 911?
  - Do you know your address?
  - Can you repeat your home phone number?
- After the quiz, discuss any questions the Tigers might have.

## **CLOSING**

- Reflection: 911 is a very serious safety tool. As Cub Scouts, the Tigers can be obedient and trustworthy by using 911 properly.
- Practice reciting the Scout Law.

## **AFTER THE MEETING**

- Serve refreshments, if desired.
- Record completion of requirements 1a, 1b, and 1c.
- Make sure everything is cleaned up.



### **Do-at-Home Project Reminder:**

Before the next meeting, Tigers with their adult partners should plan to do the following and be prepared to share it with the den:

- 1. Walk through your home together and identify where the smoke detectors are. Check the batteries and change them if necessary.**
- 2. While walking through your home, look at the available exits.**
- 3. Adult partners should help their Tigers decide where a safe meeting place will be in the event of a fire in the home.**
- 4. Draw a map and practice the drill with your family. Practice crawling (because of the smoke) and touching door handles.**
- 5. Adult partners should discuss the following with their Tigers so they can share with the den at the next meeting:**
  - Where are our smoke detectors?**
  - What kind of noise do they make?**
  - Why do door handles get hot?**
  - Where is our safe meeting place outside?**
  - What do we take? (ourselves)**
  - What do we leave? (everything else)**

# MEETING 2 PLAN

## PREPARATION AND MATERIALS NEEDED

- U.S. and den flags
- Materials for activity (list of scenarios for “Walk Away, Safe Today”)
- Blanket or towel for the Stop, Drop, and Roll activity. (The U.S. Fire Administration website provides excellent information about fire safety for children at [www.usfa.fema.gov/kids/.](http://www.usfa.fema.gov/kids/))

## GATHERING

Have Tigers practice the “stop, drop, and roll” technique or provide coloring sheets demonstrating the steps.

## OPENING

- Conduct a flag ceremony of your choosing that includes the Pledge of Allegiance and, as appropriate, the Scout Oath and Scout Law.
- Clap and stamp feet: Have the group stand and clap hands three times, then stamp feet three times, and then give a Tiger growl. Then repeat, faster and faster.

## TALK TIME

- Carry out business items for the den.
- Explain to Tigers that they should be concerned if a stranger approaches them for help. Adults should ask other adults for help, not kids. With all adults participating in this talk, explain that the activities in this meeting plan will help them learn about how to set boundaries for how Tigers are to stay safe.

## ACTIVITIES

### ◆ Activity 1: Safe Distances

- Have adult partners work with their Tigers to demonstrate and practice safe distances to stand from a stranger.
- With your arms at your sides, have your Tiger guess how long your arms are by standing where he thinks he is barely out of arm’s reach.
- Then reach your arms out, and show him if he guessed correctly or not. Because of the difference in size between Tigers and adults, many of the boys may not realize how long an adult’s arms can be.

### NOTE TO DEN LEADER

It is important to demonstrate the distances by reaching, not grabbing; we want to empower Tigers rather than foster fear. Emphasize that there are many people out there who want to keep them safe, and help them to identify those people.

## ◆ Activity 2: Walk Away, Safe Today

Have each Tiger play the Walk Away, Safe Today game with his adult partner. Role-play scenarios where the Tiger practices when to walk away. Give scenarios where they choose whether to walk firmly away or stay and help. For example: A parent asks you to make your bed (help); someone tells you that he or she has lost a puppy (walk away). There are many scenarios that can be used for the Walk Away, Safe Today activity—from strangers offering Tigers a ride to strangers asking for help with a hurt person.

### NOTE TO DEN LEADER

Most children are naturally helpful, so this can be a difficult concept for them. Make sure Tigers understand when it is OK to walk away and not feel that they're being rude. Also offer suggestions on ways to let others know they're in danger, such as screaming loudly or calling for help.

## ◆ Activity 3: Fire Safety (Requirements 2, 3, 4, and 5)

Review the questions from the Do-at-Home Project and ask each Tiger to share what he learned:

- Where are our smoke detectors?
- What kind of noise do they make?
- Why do door handles get hot?
- Where is our safe meeting place outside?
- What do we take? (ourselves)
- What do we leave? (everything else)

Boys who arrived during the Gathering were practicing their “stop, drop, and roll” technique. Explain to Tigers why they need to learn this skill (in the event they are on fire). Have each Tiger demonstrate the technique to ensure they know how to do it properly.

Have each Tiger practice with a buddy the proper way to extinguish a fire on a person. Ask adult partners to help, and use a blanket or towel to demonstrate.

## CLOSING

- Reflection: A Scout is still courteous if he walks away to stay safe.
- Recite the Scout Law.
- Review details for the Den Meeting 3 outing. Make sure all Tigers and their families know the plans.

## AFTER THE MEETING

- Serve refreshments, if desired.
- Record completion of requirements 2, 3, 4, and 5, completed during the meeting and at home.
- Work together to clean up the meeting place.
- Prepare thank-you notes for the Tigers to sign at the next meeting.



# MEETING 3 PLAN (Den Outing)

## PREPARATION AND MATERIALS NEEDED

- Decide where you are going on your trip. Be sure to plan at least a month in advance. Keep an eye on your community calendar for fire station open houses.
- Unit den leader should have in possession (if required by local council practices) the tour and activity plan, signed activity consent forms, and a copy of the *Guide to Safe Scouting*.

## GATHERING

- Explain to your Tigers what to expect while they are there.
- Practice introductions.
- Review the buddy system.
- Answer any questions that arise.
- Help them plan any questions they may want to ask the emergency responders. Consider writing the questions down.

## OPENING

- Say the Pledge of Allegiance and, as appropriate, the Scout Oath and Scout Law. If the den does not have a United States flag on the outing, ask one Scout to display the flag on his uniform for the group.

## TALK TIME

- Carry out business items for the den.
- Ask Tigers to share one way their behavior will reflect the Scout Law.

## ACTIVITIES

### ◆ Activity 1: First Responder Visit (Requirement 6)

- Visit with the first responders as planned, and encourage Tigers to ask questions at appropriate times during the presentation.

## CLOSING

- The Cub Scout motto is “Do Your Best.” For Boy Scouts, the motto is “Be Prepared.” Everything we have learned on this visit reminds us to do our best to be prepared to keep safe.
- Have Tigers thank the first responders who assisted with the tour.
- Reflect on anything the Tigers found surprising or particularly interesting during the outing. Ask them to share one item that was new to them.

## AFTER THE MEETING

- Serve refreshments, if desired.
- Send thank-you notes to those who helped with the outing.
- Record completion of requirement 6.
- Compliment the boys on their behavior.
- Announce any information for the next meeting.
- Work together to clean up the meeting place.

Upon completion of the Tiger: Safe and Smart adventure, your Tigers will have earned the adventure loop shown here. Make sure they are recognized for their completion by presenting the adventure loops, to be worn on their belts, as soon as possible according to your pack's tradition.





# TIGER TAG



## RATIONALE FOR ADVENTURE

This adventure will engage the boys in some active games with their adult partners and establish an appreciation for activity and its role in maintaining one's health and mental abilities.

## TAKEAWAYS FOR CUB SCOUTS

- Practicing skills
- Experiencing winning and losing
- Learning about sportsmanship
- Developing team spirit
- Having fun outdoors
- A Scout is cheerful. 

*Tiger Handbook, page 240*

## ADVENTURE REQUIREMENTS

1. Choose one active game you like, and tell your den about it.
2. Do the following:
  - a. Play two relay games with your den and your adult partner.
  - b. Tell your adult partner or the other Tigers what you liked best about each game.
  - c. Have your den choose a relay game that everyone would like to play, and play it several times.
3. With your adult partner, select an active outside game that you could play with the members of your den. Talk about your game at the den meeting. With your den, decide on a game to play.
4. Play the game that your den has chosen. After the game, discuss with your den leader the meaning of being a good sport.

### NOTES TO DEN LEADER

Prior to Meeting 1, have Tigers tell their adult partners about an active game they like. For requirement 1, Tigers should come prepared to share the game with their den. The game does not need to be one that the den can play, and Tigers do not need to bring equipment.

For Meeting 2, Tigers should be prepared to tell the den about an active game they would like to play as a den. If equipment is involved, Tigers should bring that equipment to the meeting. The den will choose a game to play.

This adventure does not include plans for a den outing. If an outing is desired, the leader could choose to hold Meeting 2 at a park location where Tigers will have appropriate space for playing games. All outing and transportation information would need to be planned in advance.

See the Appendix for optional den meeting activities, including openings, gatherings, and closings.

# MEETING 1 PLAN

## PREPARATION AND MATERIALS NEEDED

- U.S. and den flags
- Blindfolds for all participants and a balloon for the Gathering
- Read the Tiger Tag adventure in the *Tiger Handbook*.
- Materials for a variety of relay games (see options under Meeting 1 Resources). The games may be played inside or outside, depending on available resources.

## GATHERING

One game choice is Balloon Bluff. Place a balloon on the floor where players can see it. Blindfold them, and have them walk to where they think the balloon is and try to stomp on the balloon to pop it. Be sure to check for latex allergies in your den if you choose this activity.

## OPENING

- Conduct a flag ceremony of your choosing that includes the Pledge of Allegiance and, as appropriate, the Scout Oath and Scout Law.

## TALK TIME

- Carry out business items for the den.
- Allow Tigers to share the active games they like. Then have Tigers vote on the outdoor game to play during the next den meeting. Take into account any space or equipment limitations, as well as the needs of your specific den when selecting a game to play.
- Introduce the Tiger Tag adventure to the den.
- Describe games as an easy way to both have fun and get exercise.
- Tell Tigers that a relay game is played in teams. Each member of each team must complete some part of the relay, and then another team member completes the next part. The first team to finish is considered the winner.

## ACTIVITIES: RELAY RACES

### ◆ Activity 1: Ready, Set, Relay! (Requirement 2a)

1. Select two relay games for the den to play. (See Meeting 1 Resources for game ideas.) Set up materials as needed to play the games.
2. Relay games can be conducted as contests between members of the den or as a group, in which case the group competes against the clock.
3. Relays that might be messy are best played outside, but even then be prepared for cleanup.

### ◆ Activity 2: Relay Reflection (Requirement 2b)

1. Have Tigers tell their adult partners or the den about their favorite parts of the games they played.

### ◆ Activity 3: Den Choice Relay (Requirement 2a)

1. Provide a list of additional games for Tigers to select from.
2. Have the boys vote on another relay they would like to try. Remind them that once a game is chosen (even if it is not everyone's first choice), all members of the den should demonstrate the Scout Law by participating cheerfully.
3. Play the game several times.

## CLOSING

- If Meeting 2 will be held in a park, remind boys of the points of the Scout Law that are particularly relevant for a den outing. At minimum, note the importance of being trustworthy and obedient. For example, note that when visiting others, it is important to be obedient (e.g., don't touch if it's not allowed) and to be courteous.
- Confirm that transportation plans are in place for the den outing and families are aware of the meeting place and time.



### Do-at-Home Project Reminder:

Have Tigers work with their adult partners to select an active outside game that they could play with the members of their den. They should be prepared to talk about the game at the den meeting, and they should bring any necessary equipment to play it. The den will decide as a group on a game to play.

## AFTER THE MEETING

- Serve refreshments, if desired.
- Record completion of requirements 1, 2a, 2b, and 2c.
- Work together to clean up the meeting place.
- Prepare thank-you notes for the Scouts to sign later if Meeting 2 is at a park and volunteers will be helping.

## MEETING 1 RESOURCES

### RELAYS (REQUIREMENT 2A)

If you need ideas for games, you will find more than you can possibly use in books from the library or on any number of Internet sites. Be sure that the games are appropriate for boys of Tiger age. To keep in the spirit of Tiger Tag, be prepared to share active games with the boys in the den.

Some examples of games follow, and there are several other options in the *Tiger Handbook*.

#### Lost Shoe Relay

Materials needed: players' shoes

- Have everyone remove their shoes and put them into a pile at the far end of the room.
- Mix the pile well.
- At the signal, the first player on each team runs to the pile, finds his shoes, puts them on, and runs back to the team. The first team with everyone in their shoes wins.

#### Jump Relay

- This can be played in teams or against the clock.
- Players 1 and 2 hold a rope, string, or belt just above the floor. (It may rest on the floor if players are more comfortable with that for safety reasons.)
- Their teammates jump over it.
- When the last player jumps over the rope, player 1 goes to the end of the line and player 2 takes player 1's place. Player 3 (at the head of the line) takes player 2's place.
- The action is repeated until players 1 and 2 are back in their starting locations.
- Alternatively, players 1 and 2 move the rope down the line while each teammate jumps over it.

# MEETING 2 PLAN

## PREPARATION AND MATERIALS NEEDED

- U.S. and den flags
- Materials for any games that may be played during the meeting (See Meeting 2 Resources for some ideas.)

## GATHERING

### Frantic Object

#### Object

To keep a number of balloons in constant motion for as long as possible

#### Procedure

Everyone in the group is given a balloon (or tennis ball) or two. Play on a smooth surface that is bounded by walls. On signal, the group attempts to keep every balloon or tennis ball in motion. Adult partners or a den chief participate by spotting balloons or balls that have stopped moving.

#### Variations

- During the activity, additional tennis balls or balloons may be added, increasing the difficulty. Den members can join in at any time.
- The activity may be allowed to continue until the referees have spotted three balls or balloons that have stopped moving.

## OPENING

- Conduct a flag ceremony of your choosing that includes the Pledge of Allegiance and, as appropriate, the Scout Oath and Scout Law.
- Optional Opening: Tie the opening to the idea of games to help connect elements of the meeting. For example, to connect with sporting events, a natural opening would include singing the national anthem. Perhaps each boy and/or his adult partner passes a piece of game equipment and says a point of the Scout Law.

## TALK TIME

- Carry out business items for the den.

## ACTIVITIES

### ◆ Activity 1: Game Sharing (Requirement 3)

- Give each Tiger a turn to share the game he enjoys playing, including rules, equipment, and why he likes the game.
- Remind Scouts to be courteous listeners to other Tigers.
- After the sharing, have the den vote on which game they would like to try playing. Be sure they choose from options that are appropriate to the meeting location and the group. If any options present safety concerns, adapt the games or let Tigers know that those are not options for the meeting.

## ◆ Activity 2: Time to Play! (Requirement 4)

Ideally, the games should be conducted outside because the space will allow a broader range of game choices and a higher level of activity. The Tigers can easily be active for 20–30 minutes if they like the game. If the game is particularly active, you may need to arrange a limited role for the adult partners (e.g., judges or timers).

- Carefully explain the rules for the game selected by the den. Make any necessary adaptations.
- Set up the playing space, and check that all equipment is in place.
- Divide Tigers into teams as needed, and start to play!

### CLOSING

- After a meeting full of games, several points of the Scout Law will probably tie in to your closing comments:
  - Trustworthy (for playing fairly)
  - Helpful (for helping with the setup and game play)
  - Courteous (for good sportsmanship and listening to instructions)
  - Obedient (for following the rules)
  - Cheerful (for having fun)
- Remember the adult partners when talking about the Scout Law.

### AFTER THE MEETING

- Serve refreshments, if desired.
- Record completion of requirements 3 and 4.
- Work together to clean up the meeting place.
- If Meeting 2 was held as a den outing, have Tigers sign thank-you notes for anyone who helped.

Upon completion of the Tiger Tag adventure, your Tigers will have earned the adventure loop shown here. Make sure they are recognized for their completion by presenting the adventure loops, to be worn on their belts, as soon as possible according to your pack's tradition.



# MEETING 2 RESOURCES

## ACTIVE GAMES (REQUIREMENT 3)

### Indoor Active Games

#### Barnyard Bedlam

Gather a bunch of a specific small item, such as pom-poms, to hide around the room in piles. Divide the den into small groups. Each group will have one farmer (this can be an adult partner), and the other Tigers in each group will be one type of animal.

Have the animals practice their animal sounds, then have everyone leave the room. Hide the items, and call the group back into the room. When the game begins, animals must hunt for the item and signal to the farmer with their animal sound when they find a pile. Farmers must rush to their own animals to collect the items. Another animal can rush to the same pile and use his own animal sound to call his farmer and see if he or she can arrive first. The game should result in a loud collection of barnyard noises and frantic farmers rushing about.

The game could also be played outside, though a biodegradable item, such as peanuts or popcorn, should be used to avoid having lost items become litter. Be sure to locate and clean up all items when finished.

#### In the Pond

Mark a large circle on the ground, just slightly smaller than the circle formed when players stand arm's length apart. When the leader calls "In the pond," all players jump forward into the circle, which is the pond. When the leader calls "On the bank," players jump backward. If the leader calls "On the pond" or "In the bank," players should not move, but those who do are out.

### Outdoor Active Games

#### Balloon Balance

Each person has a balloon. Without using their hands, pairs try to hold their balloons between them and move toward a finish line or through an obstacle course.

#### Blockade

The group is divided into two teams: Blue and Gold. Each Gold team member has a token, which is to be delivered to the leader in a safety zone—a large, well-marked circle or square. As Gold team members try to get to the safety zone to deliver their tokens, the Blue team tries to capture each one, using a two-handed touch. Gold team members lose their tokens if caught, but may return to a starting point for another. After a certain time, players switch sides. At the end, the team with the most tokens is the winner.

#### Resources for Games

**The Boy Scouts of America has published an extensive list of games, available at [www.scouting.org/filestore/pdf/games.pdf](http://www.scouting.org/filestore/pdf/games.pdf)**

It's relatively easy to modify active games to make them suit your space and resources. In a relay, for example, the boys might compete against or team up with their adult partners. While the traditional relay is a race in which players face a specific challenge (e.g., carrying water or an egg in a spoon; a three-legged race), the challenge can be altered so that movement is unrestricted but a task is required at the end of the run. Likewise, a game of hide-and-seek can be turned on its head so that "it" hides while the remainder of the group hunts for him, especially if the game is conducted in a large space.





# TIGER TALES



## RATIONALE FOR ADVENTURE

Our past is exciting and important for Scouts to understand. Tiger Tales offers a glimpse of songs, stories, and customs that have been passed down through families and groups of people about the history of America. Some stories are about real people such as Davy Crockett or Daniel Boone. Their stories tend to be exaggerated to make them seem bigger than life. Other times, stories are about fictional characters capable of amazing things that seem impossible. Either way, tall tales and folk songs offer the spirit of American life from our ancestors telling us about their happiness, fears, dreams, and the hopes they shared.

## TAKEAWAYS FOR CUB SCOUTS

- Developing loyalty to our country
- Developing appreciation for their nation's culture and heritage
- Showing respect for what our ancestors have provided for us

## ADVENTURE REQUIREMENTS

*Tiger Handbook, page 250*

1. Create a tall tale with your den.
2. Create your own tall tale. Share your tall tale with your den.
3. Read a tall tale with your adult partner.
4. Create a piece of art from a scene in the tall tale you have read, using your choice of materials. Share it with your den.
5. Play a game from the past.
6. Sing two folk songs.
7. Visit a historical museum or landmark with your adult partner.

### NOTES TO DEN LEADER

Tigers will have a Do-at-Home Project after the first den meeting to complete requirements 2 and 3.

Meeting 3 is a den outing to a historical museum or landmark. The goal is to help Tigers witness some of America's past and to bring context to the stories, songs, and games they experience during this adventure. In advance of the outing, the leader will need to make arrangements with the outing location and confirm the outing plan with families, including transportation and any additional items they need to bring. Make sure a tour and activity plan has been submitted, if required, and activity consent forms are distributed, signed, and collected.

In some areas, local museums may focus on a particular subject or time period. If the place you want to go is not open during den meeting times, consider inviting a museum docent to bring some items to the meeting and speak to the Tigers.

For further reference, the Library of Congress has information on folk tales on its website: [www.loc.gov/folklife](http://www.loc.gov/folklife).

See the Appendix for optional den meeting activities, including openings, gatherings, and closings.

# MEETING 1 PLAN

## PREPARATION AND MATERIALS NEEDED

- U.S. and den flags
- Materials for games from the past—such as marbles, checkers, chalk (or tape if indoors) for hopscotch
- Tunes and lyrics to several folk songs (e.g., “Old MacDonald Had a Farm,” “I’ve Been Working on the Railroad,” or “Oh My Darling, Clementine”)
- Read the Tiger Tales adventure in the *Tiger Handbook*.

## GATHERING (REQUIREMENT 6)

- Sing “Old MacDonald Had a Farm” or other folk songs, getting the Tigers to add an animal for a verse as they arrive.

## OPENING

- Conduct a flag ceremony of your choosing that includes the Pledge of Allegiance and, as appropriate, the Scout Oath and Scout Law.
- Sing a patriotic song such as “God Bless America” or “America the Beautiful.”

## TALK TIME

- Carry out business items for the den.
- Talk Time is a great opportunity for Tigers to describe what they think a tall tale is. Ask if they can think of any tall tales they may have read before or heard from someone in their family.
- Provide background information on tall tales:

Stories handed down from families or groups of people about the American past are called tall tales. Many times, the stories give us a picture of what life was like a long time ago. They can be told as songs or spoken in ways that make the tale more entertaining. Some tall tales are stories about real people while others are about fictional characters capable of doing things a real person would not be able to do. Whether or not the stories are true, tall tales offer exciting adventures with wonderful characters and tell us about the spirit of our ancestors.

## ACTIVITIES

### ◆ Activity 1: Group Tall Tale (Requirement 1)

In this activity, Tigers will create a tall tale as a group. Sitting in a circle makes this much more interesting and organized. Start a story with one or two sentences. Then have the person sitting next to you add one or two sentences. Continue around until everyone has had an opportunity to add to the tale. How exaggerated did the tall tale become?

### ◆ Activity 2: Games From the Past (Requirement 5)

Have the den play a game from the past. Simple games children played in earlier generations (and sometimes still do!) include hopscotch, checkers, tag, SPUD, jump rope, jacks, marbles, hide-and-seek, or Mother, May I? Consider setting up more than one game so Tigers can rotate through several to experience different kinds of games. (See Meeting 1 Resources for some game directions.)

## CLOSING

- Gather Tigers and adult partners in a circle. Ask the Tigers to close their eyes and then have the adult partners step into the center of the circle. Ask each partner to tap one of the Tigers on the shoulder and say:

I enjoyed singing a folk song with \_\_\_\_\_.

I enjoyed playing with \_\_\_\_\_.

\_\_\_\_\_ was a really good storyteller.

\_\_\_\_\_ did a good job playing the games.

Partners can also add positive comments of their own. This activity gives all Tigers a pat on the back for doing a good job. It also sets a quiet tone for the closing time of the meeting. When all the boys have been recognized in this way, tell them to open their eyes and give their den yell/cheer or a loud Tiger growl!



### Do-at-Home Project Reminder:

This week, Tigers will complete requirements 2 and 3 at home. Each Tiger should choose a tall tale to read at home. You can find tall tales at a local bookstore, or school or public library. Tigers can read with their adult partners. Talk about what makes a tall tale, and discuss the following questions:

- Is this a tale that you would like to hear again?
- Is this a tale that you would like your friends to hear?
- What part did you like best and why?

Then, before the next den meeting, help your Tiger create a new tall tale of his own. Think about how to make the story an exciting tall tale that will be fun to share with the den. The tale can be written down, drawn cartoon-style, or recorded. Let your imaginations run wild, Tigers!

### AFTER THE MEETING

- Serve refreshments, if desired.
- Record completion of requirements 1, 5, and 6.
- Work together to clean up the meeting place.
- Prepare thank-you notes for the Scouts to sign at the next meeting.

## MEETING 1 RESOURCES

### GAMES FROM THE PAST

#### Hopscotch

**Materials needed:** chalk (if outdoors) or tape (if indoors), small rocks or other items for tossing onto the squares

1. Draw a number grid using chalk outside on a sidewalk, or use tape on the floor if indoors. Make squares large enough for boys to land both feet in them.
2. Have each player select a little rock, bean bag, or other small item that is good for tossing.
3. The first Tiger begins by tossing a rock onto the square marked "1." He must then hop over the rock and the number 1 square, and land in the number 2 square on one foot.
4. Then he hops to the end of the grid on the same foot, turns, and hops back to the number 2 square. While balancing on one foot in square 2, the Tiger must lean over, pick up the rock from square 1, and hop off the hopscotch board.
5. The same boy then continues the pattern, tossing the rock into square 2, and so on. If at any time he throws the rock outside a square, he loses his turn and the next Tiger goes.
6. The game continues until a player wins by successfully completing all numbers from 1 through 9.



## Button, Button, Who's Got the Button?

**Materials needed:** a button or other small object

Have the Tigers sit in a circle. One Tiger will be "it." Ask him to leave the room or to stand up and close his eyes. Then tell all the others to put their hands behind their backs and give one of them a button or other small object to begin passing around the circle. At your signal, the Tiger who has the button will keep holding it, and the Tiger who is "it" will return to the room or open his eyes. "It" gets three guesses to figure out which Tiger has the button. If he guesses correctly, he sits down and the Tiger with the button becomes "it."

## SPUD

**Materials needed:** any ball that is soft and won't hurt when it hits someone, or a rolled-up pair of socks

1. Every Scout is assigned a number from 1 to the number of players.
2. Players form a close circle with one Scout in the center who has the ball.
3. The Scout throws the ball straight up as high as he can and yells out one of the numbers.
4. Everyone scatters except the Scout whose number was called. He catches or picks up the ball. As soon as he has the ball, he yells "SPUD," and everyone must freeze.
5. The Scout with the ball can then take up to three giant steps toward any Scout he wants. He throws the ball at the Scout, who can move all parts of his body to dodge the throw—except his feet.
6. If the Scout is hit, he gets S. If he isn't hit, the thrower gets S.
7. Everyone gets back into a circle, and the Scout who received the letter throws the ball up for the next round.
8. When a Scout has acquired the letters S, P, U, and D, he is out of the game. Or, after a set period of time, the player with the fewest letters is the winner.

# MEETING 2 PLAN

## PREPARATION AND MATERIALS NEEDED

- U.S. and den flags
- Paper for nametags or copies of the "Hello, my name is ..." template to be used in the Gathering activity.
- Provide assorted art materials for the tall tale art project in Activity 1. Include a variety of papers, markers, crayons, yarn, buttons, recycled materials, tape, and other materials to give boys choices.
- Optional: During Activity 2, Tigers will share the tall tales they created. As an option, you might choose to set the scene for the way tall tales were often shared in the past by providing a special storyteller hat or stool or even a mock campfire.
- Thank-you notes for Scouts to sign before the upcoming den outing

## GATHERING

As Tigers arrive, have them create personalized nametags for the tall tale characters they read about at home. Have each boy include his character's name and add other appropriate decoration.

## OPENING

- Conduct a flag ceremony of your choosing that includes the Pledge of Allegiance and, as appropriate, the Scout Oath and Scout Law.
- Sing a patriotic song.

## TALK TIME

- Carry out business items for the den.
- Have Tigers put on the tall tale character nametags they created during the Gathering. Then each boy “introduces” himself as the character and shares a little with the group. Another option is to pair up Tigers and give them a brief time to share with each other about their characters. Then the group gets back together and each Tiger can introduce his buddy as a character he just “met.” For example, a Tiger might start by gesturing to his partner and saying, “This is Paul Bunyan. He once did the most amazing thing ...” (requirement 3).

## ACTIVITIES

### ◆ Activity 1: Folk Tale Art Project (Requirement 4)

- Tell Tigers they will be creating an art project to show a favorite scene from the tall tale that they read.
- Provide a variety of art materials for the Tigers so they can choose how they would like to create the scene.
- Encourage Tigers to be creative and add details to tell about the story through their art.

### ◆ Activity 2: Sharing Tigers’ Tall Tales (Requirement 2)

Now have Tigers share the tall tales they created at home. Gather the group in a circle, and have them imagine a campfire scene long ago—exactly the kind of setting where tall tales might have been shared over and over again. Give each Tiger the opportunity to read or present the tall tale he created. Encourage the Tigers to remember the Scout Law and be friendly listeners as they hear the other Tigers’ stories.

## CLOSING

- If time permits, ask questions such as the following:
  - What makes these stories “tall tales”?
  - Why did you choose to write your tall tale about ...?
  - What part of your tale do you think is the best part? The funniest part? The most exciting part? ... Why?
  - What did you enjoy most: writing the tall tale, reading it, or creating the art? Why?
- A final thought for Tigers: The past is exciting and important. It tells stories of how others lived before us and the hopes and dreams they had for America. We can learn to be loyal to our country and respectful of the things we have today because of our ancestors.
- Review details for the Den Meeting 3 outing. Make sure all Tigers and their families know the plans.

## AFTER THE MEETING

- Serve refreshments, if desired.
- Record completion of requirements 2, 3, and 4.
- Work together to clean up the meeting place.
- Have Tigers sign thank-you notes for the upcoming den outing.

# MEETING 3 PLAN (Den Outing)

## PREPARATION AND MATERIALS NEEDED

- Unit den leader should have in possession (if required by local council practices) the tour and activity plan, signed activity consent forms, and a copy of the *Guide to Safe Scouting*.
- Work with the historical location you have selected to coordinate a tour guide, if possible, or make plans for the den's visit.

## GATHERING

- Designate a meeting place for the end of the tour, and be sure everyone is aware of its location.
- Next, if the location is outdoors, perhaps engage the boys in one of the games that they played during the first meeting. If inside, you can play a guessing game such as Button, Button (see Meeting 1 Resources).

## OPENING

- Say the Pledge of Allegiance and, as appropriate, the Scout Oath and Scout Law. If the den does not have a United States flag on the outing, ask one Scout to display the flag on his uniform for the group.

## TALK TIME

- Carry out business items for the den.
- Remind Scouts of the expected behavior for the outing. Be aware of any special restrictions or guidelines for your particular location.

## ACTIVITIES

### ◆ Activity 1: Museum or Historical Site Visit (Requirement 7)

Have everyone pay close attention to the tour guide (if available) and the displays. Remind Tigers to be respectful of others. Ask the boys to identify differences between what they see in the exhibits and the world today. Examples might include changes in clothing styles, tools, and buildings. Are there things from the past that they might have liked more, compared to today?

## CLOSING

- If your group had a guide for the visit, be sure to express your appreciation. Give thank-you notes signed by the Tigers at the previous meeting.
- Ask what the Tigers liked most about the den outing. Did they learn something about their past? What was it?

## AFTER THE MEETING

- Record completion of requirement 7.

Upon completion of the Tiger Tales adventure, your Tigers will have earned the adventure loop shown here. Make sure they are recognized for their completion by presenting the adventure loops, to be worn on their belts, as soon as possible according to your pack's tradition.





# TIGER THEATER



## RATIONALE FOR ADVENTURE

Children love to pretend. They start at a young age by imitating what is around them. By the time they reach school age, they are ready for the next step: creating their own adventures to share. Theater provides an avenue to learn about public presentations and builds confidence in public speaking. Encouraging Tigers to perform helps them to become strong speakers and leaders, both in Scouting and in their daily lives.

## TAKEAWAYS FOR CUB SCOUTS

- Increased confidence
- Developing imagination
- Critical thinking and problem solving
- Observation skills
- Ability to work with others
- A Scout is brave. 

*Tiger Handbook, page 264*

## ADVENTURE REQUIREMENTS

1. With your den, discuss the following types of theater: puppet shows, reader's theater, and pantomime.
2. As a den, play a game of one-word charades with your adult partners.
3. Make a puppet to show your den or display at a pack meeting.
4. Perform a simple reader's theater. Make a mask afterward to show what your character looks like.
5. Watch a play or attend a story time at a library.

### NOTES TO DEN LEADER

Meeting 3 will be a den outing to a play or a library story time. In advance of the outing, the leader will need to make arrangements with the outing location and confirm the outing plan with families, including transportation and any additional items they need to bring. Make sure a tour and activity plan has been submitted, if required, and activity consent forms are distributed, signed, and collected.

See the Appendix for optional den meeting activities, including openings, gatherings, and closings.

## MEETING 1 PLAN

### PREPARATION AND MATERIALS NEEDED

- U.S. and den flags
- Box of hats
- Reader's theater materials. See options for Activity 2 below, and prepare copies of a skit or paper slips in advance.
- Balloons (optional) for reader's theater
- Materials needed for a mask—list will vary based on type of mask selected
- Read the Tiger Theater adventure in the *Tiger Handbook*.

## GATHERING

Provide a box containing many types of hats, such as a baseball cap, top hat, fishing hat, Halloween mask, football helmet, and cowboy hat. Have each Tiger put on a hat and with his adult partner create a character to go with the hat. After a set number of minutes, have everyone change hats.

## OPENING

- Conduct a flag ceremony of your choosing that includes the Pledge of Allegiance and, as appropriate, the Scout Oath and Scout Law.
- Sing a patriotic song such as “You’re a Grand Old Flag” or “This Land Is Your Land.” Have the boys develop hand motions to go along with the songs.

## TALK TIME (REQUIREMENT 1)

- Carry out business items for the den.
- Give each Tiger time to share information about his week. You might use a talking stick, talking feather, or other item to help moderate the time and encourage respect for the speaker.
- Introduce the Tiger Theater adventure to the den. Explain that there are many types of theater. The types you will be looking at in this meeting are puppet shows, reader’s theater, and mime. Explain each type, and note the similarities and differences of each one.

## ACTIVITIES

### ◆ Activity 1: Charades (Requirement 2)

Play charades as a group (including adult partners). Keep the game simple for beginners; consider using animals, emotions, or simple actions.

### ◆ Activity 2: Reader’s Theater (Requirement 4)

- Have everyone participate in a reader’s theater.
- For a traditional reader’s theater activity:
  - Go online or visit a local library to select a brief skit that is appropriate for the Tigers in your den and includes the correct number of parts. There are many free educational or Scouting resources for reader’s theater.
  - Make a copy of the script for each Tiger and distribute the copies.
  - Allow several minutes for Tigers and their adult partners to practice the reader’s theater together. Be aware that many Tigers will need assistance from their adult partners, and allow them to read and perform the part together with their adult partners if they prefer. Another option is to choose a skit in which some parts have several boys speaking together as a group or require only brief, simple lines.
  - After several minutes of practicing their parts with adult partners, gather the group and “perform” the reader’s theater. Ask adult partners to sit next to their Tigers to guide them and help them follow along in the script. Costumes and props are not required, but Tigers should be encouraged to add expression, characterization, and gestures to their parts.
- As an alternative to a traditional reader’s theater, leaders may choose the following activity:  
I Remember When.
  - Prepare by cutting apart the following boxes into slips of paper.
  - Then do one of the following:
    - **Option 1:** Put all the slips in a hat and have each player draw one. (Adult partners may choose to participate.) Each player begins by saying, “I remember when,” then reads the sentence, and finishes the statement or adds to the story. Continue around the group until everyone has contributed.
    - **Option 2:** Put all the slips of paper in separate balloons and then inflate them. Place the balloons around the room, and play music. When the music is playing, everyone must be in motion. When the music stops, everyone must find a balloon and sit on it to break it. Then each player reads his slip to the group, in turn, and finishes the statement or adds at least one sentence to the story.



I walked on the moon.

I rode in a rocket to Mars.

I tamed a Tyrannosaurus rex.

I sailed across the ocean  
in a rowboat.

I drove a race car 200 mph.

I starred in a movie about  
\_\_\_\_\_.

I was elected president of the United  
States.

I woke up inside a cartoon.

I rode a bucking bronco  
in the rodeo.

I invented a new  
\_\_\_\_\_.

I climbed the side of a  
100-story building.

I wrestled an alligator.

### ◆ Activity 3: Make a Mask (Requirement 4)

Make a mask. Review the different ideas below and choose what would work best for your den. Also feel free to come up with your own ideas, keeping in mind that the mask project should be appropriate for a Tiger.

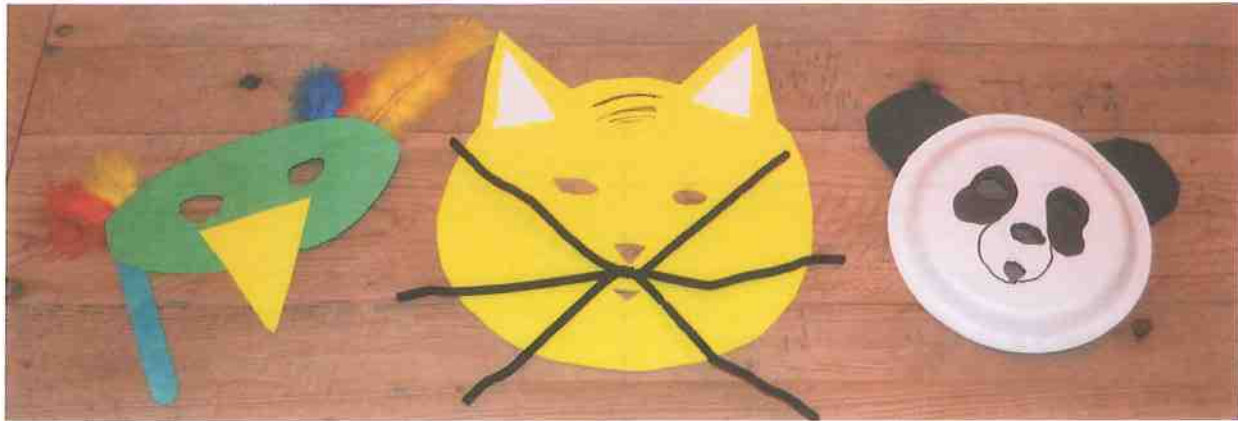

### CLOSING

- Recite the Scout Law.
- Identify which points of the Scout Law relate to being in front of an audience

### AFTER THE MEETING

- Make sure that everything is cleaned up.
- Serve refreshments, if desired.
- Record the completion of requirements 1, 2, and 4.

## MEETING 2 PLAN

### PREPARATION AND MATERIALS NEEDED

- U.S. and den flags
- Items will vary based on the type of puppet selected.
- Cards with animal pictures for Gathering activity
- Coordination with upcoming pack meeting
- Flier for the Den Meeting 3 outing

### GATHERING

Participate in “Imaginary Animal Mix-Ups.” Create cards, half of which show an animal’s head and half that show only an animal’s body. Have each Tiger and adult partner draw a card from a hat. Ask them to put their cards together and create a story about their new imaginary animal.

### OPENING

- Conduct a flag ceremony of your choosing that includes the Pledge of Allegiance and, as appropriate, the Scout Oath and Scout Law.

### TALK TIME

- Carry out business items for the den.
- Allow Tigers and adult partners time to share the stories of their new animals.

## ACTIVITIES

### ◆ Activity 1: Making Puppets (Requirement 3)

Have each Tiger create a puppet. See some of the examples below and in the *Tiger Handbook*. If you have a different idea for a type of puppet, that is fine as long as it will be appropriate for Tiger age level.



### ◆ Activity 2: Puppet Performance

Have Tigers use their puppets to perform skits for the den. Cut out two-person jokes from the “Grin and Bear It” section of *Boys’ Life* magazine. Each Tiger/adult partner pair should then select a joke and practice standing in front of the group to deliver the joke as a skit.

### ◆ Activity 3: Mime Game

Play “Mirror, Mirror.” Tigers will pair up with their adult partners and face each other. The narrator calls out different actions, such as “Brush your teeth,” “Brush your hair,” “Bounce a ball,” “Eat an ice cream cone,” “Ride a bike,” or “Decorate a cake.” The pairs must mime each action together as if they are watching themselves in a mirror.

## CLOSING

Here are some simple questions for parents that can help boys reflect and grow from this activity:

- Which is more difficult: just doing the actions in “Mirror, Mirror,” or doing them so you and your partner will match? Why?
- How did it feel to perform with your puppet?
- Would you like to use your puppets or masks to perform something during a pack meeting? What would you perform?
- Close the meeting by having each Tiger give himself a pat on the back for “showing his stripes”!
- Review details for the Den Meeting 3 outing. Make sure all Tigers and their families know the plans.

## AFTER THE MEETING

- Work together to clean up the meeting place.
- Serve refreshments, if desired.
- Record the completion of requirement 3.

# MEETING 3 PLAN (Den Outing)

## PREPARATION AND MATERIALS NEEDED

- Confirm outing arrangements.
- Unit den leader should have in possession (if required by local council practices) the tour and activity plan, signed activity consent forms, and a copy of the *Guide to Safe Scouting*.

## GATHERING

- Discuss appropriate behavior with the Tigers prior to attending the story hour or play. Emphasize what it means to be a respectful audience.
- Remind the Tigers to look after each other during the outing, using the buddy system.

## OPENING

- Say the Pledge of Allegiance and, as appropriate, the Scout Oath and Scout Law. If the den does not have a United States flag on the outing, ask one Scout to display the flag on his uniform for the group.

## TALK TIME

- Carry out business items for the den.

## ACTIVITIES

### ◆ Activity 1: Attend a Play or Story Hour (Requirement 5)

Attend story hour at a local library or go to a live play.

## CLOSING

- Compliment the Tigers on their behavior during the performance.
- Ask them to share their favorite parts.

## AFTER THE MEETING

- Send thank-you notes to everyone who helped with the outing.
- Record completion of requirement 5.

Upon completion of the Tiger Theater adventure, your Tigers will have earned the adventure loop shown here. Make sure they are recognized for their completion by presenting the adventure loops, to be worn on their belts, as soon as possible according to your pack's tradition.



# APPENDIX

The appendix gathers information that you may find helpful for leading any of the adventures.

## Appendix 1: Parts of Your Meeting

### ◆ Gathering Activities .....A-7

Baden-Powell Says.....	A-7
Concentration .....	A-7
Craft Stick Puzzles.....	A-7
Hot or Cold .....	A-7
Marble Golf .....	A-7
Milk Jug Toss .....	A-7
Odd or Even.....	A-8
Pong.....	A-8
Puzzle Mania.....	A-8
Spotlight.....	A-8

### ◆ Opening Ceremonies and Ideas .....A-8

#### Openings

• Cub Scout/Webelos Scout Light .....	A-9
• Den Flag Opening .....	A-9
• Den Yell Opening.....	A-9
• Handshake Opening .....	A-9
• Opening/Closing Song Ceremony .....	A-9
• Outdoor Code Opening .....	A-9
• Pledge of Allegiance Opening.....	A-10
• Roll Call Opening .....	A-10
• Scout Law Opening .....	A-10
• Scout Oath Opening .....	A-10
• Scout Oath or Scout Law Meaning Opening .....	A-10
• T-I-G-E-R Opening Ceremony .....	A-10
• Tiger Opening (or Closing) .....	A-10

#### Flag Ceremonies to Open and Close Den Meetings

• Flag Ceremony Planning.....	A-11
• Create Your Own Opening With the U.S. Flag.....	A-11
• Flag Ceremony Comments .....	A-11
• Standard Indoor Flag Ceremony Using Flag Stands .....	A-12
• Retrieval of Colors Indoors .....	A-14
• Standard Outdoor Flag Ceremony Using a Flagpole.....	A-14
• Retrieval of Colors—Flagpole .....	A-15

<b>◆ Talk Time Suggestions .....</b>	<b>A-16</b>
Dues.....	A-16
Advancement.....	A-16
Outings or Tours .....	A-17
Communicating the Pack and Den Calendar.....	A-21
Cub Sharing Time.....	A-21
Denner Investiture.....	A-21
Meeting Information.....	A-22
Groundwork for Future Advancement .....	A-22
<b>◆ Closing Ceremonies .....</b>	<b>A-22</b>
Brotherhood Circle Closing .....	A-22
Flag Folding Closing .....	A-22
Friendship Circle Closing.....	A-22
Handshake Closing.....	A-22
Leader’s Minute Closing .....	A-22
Living Circle Closing .....	A-22
Mountain Climbing Closing Thought .....	A-23
My Flag Closing .....	A-23
Patriotic Song Closing.....	A-23
Square Knot Closing.....	A-23
Tiger Closing Song .....	A-23
We Meet as Cub Scouts Closing .....	A-23
<b>◆ Den Outings.....</b>	<b>A-24</b>
Outings .....	A-24
Hikes.....	A-24
Planning Den Outings and Excursions .....	A-24

## **Appendix 2: Working With Boys**

---

<b>◆ Boy Behavior .....</b>	<b>A-25</b>
<b>◆ How to Achieve Positive Behavior .....</b>	<b>A-25</b>
Expectations .....	A-25
Code of Conduct .....	A-25
Two-Deep Leadership.....	A-25
The Den Chief .....	A-26
Den Meeting Structure.....	A-26
Leader/Scout Relationship .....	A-26

◆ <b>Tracking Behavior</b> .....	<b>A-27</b>
Conduct Candle.....	A-27
Tickets .....	A-27
Marble Jar.....	A-27
Stickers and Certificates.....	A-27
Super Star Pins.....	A-27
Super Star Notes .....	A-27
Coup Stick.....	A-27
◆ <b>Den Doodles and Den Flags</b> .....	<b>A-28</b>
Den Doodles .....	A-28
Den Flags.....	A-28
Bases for Den Doodle or Den Flag .....	A-28
◆ <b>Den Leader “Survival” Kit</b> .....	<b>A-29</b>
◆ <b>Guidelines for Specific Types of Special Needs and Disabilities</b> .....	<b>A-29</b>
Mobility Impairments .....	A-29
Hearing Loss.....	A-30
Vision Impairments .....	A-30
Speech/Language Disorders .....	A-30
Cognitive Disabilities.....	A-30
Social/Emotional Impairments.....	A-30
Autism Spectrum Disorder.....	A-31
Attention Deficit Disorder.....	A-31
Learning Disabilities.....	A-31

## **Appendix 3: Crafts**

---

◆ <b>Why We Use Crafts</b> .....	<b>A-32</b>
◆ <b>Teaching Crafts to Cub Scouts</b> .....	<b>A-32</b>
◆ <b>Helping the Boy With Crafts</b> .....	<b>A-33</b>
◆ <b>Resources for Craft Materials</b> .....	<b>A-33</b>
Using Salvage.....	A-34
Tips for Painting.....	A-35
Tips for Adhesives .....	A-35

## Appendix 4: Games

---

◆ Why We Use Games.....	A-36
◆ How to Choose Games.....	A-36
◆ Suggestions for Leading Games .....	A-37
◆ Choosing “It” and Teams .....	A-38
◆ Cooperative Games .....	A-38
◆ Making Games Count—Leading Reflections .....	A-38
◆ Games .....	A-40
Active Games With Equipment .....	A-40
• Balloon Battle Royal.....	A-40
• Cat’s Tail.....	A-40
Active Games Without Equipment.....	A-40
• Bear in the Pit .....	A-40
• Shere Khan (The Tiger Game).....	A-40
Ball Games.....	A-41
• Bucketball .....	A-41
• Monkey in the Middle.....	A-41
Bicycle Games.....	A-41
• Bike Relay .....	A-41
• Coasting Race .....	A-41
Knot Games .....	A-42
• Giant Square Knot .....	A-42
• Knot Card Game .....	A-42
Noncompetitive, Cooperative, and Team-Building Games .....	A-42
• Batting Down the Line .....	A-42
• Blanket Ball.....	A-42
Parachute Games .....	A-42
• Parachute Volleyball.....	A-42
• The Umbrella.....	A-42
Relays and Races .....	A-43
• Balloon Sweeping Relay .....	A-43
• Balloon Kangaroo Jumping .....	A-43
Physical Fitness Activities.....	A-43
• Circle Hop .....	A-43
• Crab Walk .....	A-43



Quiet Games With Equipment .....	A-43
• Clip It.....	A-43
• Blowball .....	A-43
Quiet Games Without Equipment .....	A-44
• Above and Below.....	A-44
• Electric Squeeze .....	A-44
Homemade Games.....	A-44
• Homemade Ring Toss.....	A-44
• Teeterboard Jousting .....	A-44
Tire Games.....	A-44
• Roll for Distance.....	A-44
• Tire Rolling Relay .....	A-44
Water Games .....	A-45
• Up and Under .....	A-45
• Cork Retrieve .....	A-45
• Live Log .....	A-45
Winter Games in the Snow .....	A-45
• Fox and Geese.....	A-45
• Snowball Sharpshooting.....	A-45

## Appendix 5: Outdoors

---

◆ <b>What to Do If Lost</b> .....	<b>A-46</b>
◆ <b>Health and Safety</b> .....	<b>A-46</b>
◆ <b>Fun on Hikes</b> .....	<b>A-47</b>
◆ <b>Types of Hikes</b> .....	<b>A-48</b>
Seasons Hike .....	A-48
Web of Life.....	A-48
Tracks and Signs .....	A-48
Micro Hike.....	A-48
Nature Safari.....	A-48
Sense of Touch .....	A-49
Nature Babies .....	A-49
Heads-Tails Hike .....	A-49
Nature Noises .....	A-49
Count the Colors.....	A-49
Inch Hike.....	A-49
A-B-C Hike.....	A-49
String-Along Hike.....	A-50
Surprise Breakfast Hike .....	A-50

Night Hike .....	A-50
Silent Hike.....	A-50

**◆ Hiking Games .....A-50**

Know Your Rock .....	A-50
Know Your Leaf.....	A-50
Grab Bag.....	A-51
Nature Photographer .....	A-51
Nature Kim's Game.....	A-51
Camouflage Trail .....	A-51
Nature Scavenger Hunt .....	A-51

**◆ BSA Outdoor Ethics Program .....A-52**

The Outdoor Code.....	A-52
Leave No Trace Principles for Kids.....	A-52

**Appendix 6: Resource Guide for Aquatics Activities**

---

**◆ Water Safety .....A-53**

**◆ BSA Safe Swim Defense .....A-54**

**◆ BSA Safety Afloat (Boating Safety) .....A-55**

**◆ Swim Classification Tests .....A-56**

**◆ Swimmer Classifications.....A-56**

**◆ Testing Procedure.....A-58**

**◆ Swim Test Anxiety.....A-60**

**Appendix 7: Leader Helps**

---

**◆ Knots and Ropes.....A-62**

**Appendix 8: Awards**

---

**◆ Awards Cub Scouts Can Earn .....A-63**

**Appendix 9: Additional Resources**

---

# APPENDIX 1

## PARTS OF YOUR MEETING

### GATHERING ACTIVITIES

#### ◆ BADEN-POWELL SAYS

This game is played like Simon Says. The leader is at the front and gives a command to perform an action (i.e. "Stand on your left foot."). If the leader begins the command with "Baden-Powell says," then everyone does the action. If the action is done incorrectly, the boy is out. If the command does not begin with "Baden-Powell says," and the action is performed, the boy is out.

#### ◆ CONCENTRATION

Select pairs from a deck of cards depending on the size of the den. Lay the cards out on the top of the table face down. Each player turns over two cards. If they match, he keeps the pair and wins a point. If they do not match, he turns the cards he selected face down in the same place, and the game continues to the next player. The Scouts can make their own sets of cards by selecting pictures from magazines to cut in half and mount on card stock.

#### ◆ CRAFT STICK PUZZLES

Give each Scout the same number of craft sticks, laying them side by side to form a square. Each Scout draws a picture covering all the sticks. Once drawn, they trade pieces with another Scout, and try to put the puzzle back together.

#### ◆ HOT OR COLD

Select a player to leave the room while an object is hidden. Select an item to hide in the meeting room. Once the player leaves the room and the item is hidden, the player comes back in and tries to locate the object. The player is given clues to the location by getting directions from the den such as "You're getting hotter" as they move closer, or "You're getting colder" as they move away from it. Signals can also be given by beating on the bottom of an aluminum pie plate with a spoon. As the player nears the item, the drum beats faster and louder; as the player moves farther away, the drum beats slower and softer.

#### ◆ MARBLE GOLF

Create a three-hole marble "golf" course using items such as coins or buttons as the tee boxes and cups as the holes. Place each cup on its side several feet away from its tee box. Each Scout shoots his marble from the tee box toward the hole. The Scout should count his number of shots to get to the hole. Once the first hole has been conquered, he moves on to the next hole. The Scout with the lowest score wins. You can make the course harder by putting obstacles in the way.

#### ◆ MILK JUG TOSS

Gather enough milk jugs for each member of the den to have one. Cut the bottom of the milk jug out so that it is large enough to catch a bean bag, ping pong ball, rolled up sock, or wiffle ball. Make sure to toss an item that will not hurt if it strikes the player and is soft enough not to break whatever it strikes.



## ◆ ODD OR EVEN

Every player starts with five pennies. They select a number between 0 and 5, and put that number of pennies in one fist. Go to different players and ask, "Odd or even?" If the players guess right, they win a penny. If they guess wrong, they lose a penny. Continue circulating among the players until time is up. (It is acceptable to ask the same player multiple times.)

## ◆ PONG

Create pairs of players, and seat them across from each other with table space between them. Each player has a straw, and each pair of players has a ping pong ball or cotton ball. Put the ball between the two players and say "Go!" The object is to blow the item off the table on your opponent's side.

## ◆ PUZZLE MANIA

Provide one small puzzle for each Scout. Place each puzzle in a plastic bag; however, put some of the pieces in different bags so that each Scout will have to go to the other Scouts to hunt for the pieces that match his puzzle. To make this more challenging, do not show them the completed puzzle pictures.

## ◆ STOPLIGHT (SIMILAR TO RED LIGHT, GREEN LIGHT)

The caller stands at the front of the room with one green bandanna, one red bandanna, and one yellow bandanna. The other boys should be lined up away from the leader. With his back to the players, the leader will hold up one bandanna at a time. The leader should keep the bandannas as hidden as possible to keep the next action a surprise. Red means stop, green means go, and yellow means go slow. The first boy to reach the leader becomes the leader and the game begins again.

# OPENING CEREMONIES AND IDEAS

The following guidelines will help the den participate in ceremonies that are well prepared and well received:

- An opening ceremony signals the beginning of the den meeting. It also sets the tone for the meeting. Most opening ceremonies include a flag ceremony, which provides an opportunity to teach boys how to handle and present the U.S. flag in a respectful way. A closing ceremony brings the meeting to a close for the Scouts.
- Know your audience. Keep your openings and closings appropriate for boys of Cub Scout age. Simple ones are more effective than long, elaborate ones because boys this age have short attention spans.
- Rotate responsibilities among the boys in your den for the opening, flag, and even closing ceremonies at your den meeting. When boys are involved, it is easier to hold their attention during the meeting.
- Use a variety of ceremonies to hold the boys' and adults' interest. Keep track of which ones you use and avoid repeating them meeting after meeting. Variety is as important as length. Den openings and closings should be kept short. Openings should be no longer than two or three minutes. Closings may be a little longer but still should be age-appropriate.
- You may adapt any ceremony to meet your needs. Dens come in many different sizes, and boys come with different skill levels. Younger boys may need to have someone read their lines while they perform an action or hold a sign. No ceremony is written in stone. Feel free to make changes to work for you!
- **NOTE:** A prayer can also be added to each opening or closing.



## CUB SCOUT/WEBELOS SCOUT LIGHT

The den leader asks den members to sit on the floor in a circle and dims the lights. Have a small candle and larger candle, plus matches, on a table. Flashlights or battery-operated candles may be used instead of regular candles and matches.

**DEN CHIEF:** I will light this small candle. It represents the goodwill given by one Cub Scout. See how it shines? The rays from several Cub Scouts make a brighter light. Each Scout lets his light shine by doing his best and helping other people.

**DEN LEADER:** I'll light this large candle. This represents that there is a brighter light that leads us all. Let us always think first of God, second of others, and finally of ourselves.

### ◆ DEN FLAG OPENING

The den forms a tight circle with the den flag in the center. Each boy grasps the flagpole with his left hand, makes the Cub Scout sign with his right hand, and says the Scout Oath.

### ◆ DEN YELL OPENING

Give your den yell.

### ◆ HANDSHAKE OPENING

The denner calls the roll, and each member of the den comes forward and gives him the Scout handshake.

### ◆ OPENING/CLOSING SONG CEREMONY

Select a song from the *Cub Scout Songbook* to sing as your opening or closing. You might also select a song related to the adventure to sing as the opening or closing ceremony.

### ◆ OUTDOOR CODE OPENING

**Preparation:** Five boys walk in with the U.S. flag.

**CUB SCOUT 1:** *As an American, I will do my best to be clean in my outdoor manners.*

**NARRATOR:** I will treat the outdoors as a heritage. I will take care of it for myself and others. I will keep my trash and garbage out of lakes, streams, fields, woods, and roadways.

**CUB SCOUT 2:** *As an American, I will be careful with fire.*

**NARRATOR:** I will prevent wildfire. I will build my fires only where they are appropriate. When I have finished using fire, I will make sure it is cold-out. I will leave a clean fire ring or remove all evidence of my fire.

**CUB SCOUT 3:** *As an American, I will be considerate in the outdoors.*

**NARRATOR:** I will treat public and private property with respect. I will use low-impact methods of hiking and camping.

**CUB SCOUT 4:** *As an American, I will be conservation minded.*

**NARRATOR:** I will learn how to practice good conservation of soil, waters, forests, minerals, grasslands, wildlife, and energy. I will urge others to do the same.

**CUB SCOUT 5:** *Let us think about these responsibilities as we stand and sing "America the Beautiful."*

## ◆ PLEDGE OF ALLEGIANCE OPENING

The den gathers in a semicircle or horseshoe formation. One boy presents the colors (the U.S. flag) at the open end of the horseshoe. In turn, each boy steps forward, gives the Cub Scout salute, and steps back. Follow with the Pledge of Allegiance.

## ◆ ROLL CALL OPENING

The denner calls roll, and the boys respond by naming an item related to the adventure.

## ◆ SCOUT LAW OPENING

The den forms a circle, gives the Cub Scout salute, and says the Scout Law. (Webelos Scouts may give the Boy Scout salute.)

## ◆ SCOUT OATH OPENING

The Cub Scouts form a large circle. Their adult partners, parents, or guardians (if present) form an outer circle by standing behind their Scouts. All say the Scout Oath in unison.

## ◆ SCOUT OATH OR SCOUT LAW MEANING OPENING

Select a phrase from the Boy Scout Oath or Scout Law, and talk about its meaning.

## ◆ ROLL CALL OPENING

(Can be adapted for Wolf or Bear Scouts)

As the den meeting host calls roll, each Tiger team responds with a loud tiger growl.

## ◆ T-I-G-E-R OPENING CEREMONY

Each Tiger holds a poster with a letter on it. After he shouts his letter, his adult partner reads the statement matching the letter. (Tigers only)

**ADULT 1:** *T is for TEAM, the Tiger team, a boy and his adult partner having fun together.*

**ADULT 2:** *I is for INTRODUCTION, showing us what Cub Scouting is all about.*

**ADULT 3:** *G is for GOOD TIMES, having fun together as a den and with your family.*

**ADULT 4:** *E is for EXPLORING, searching out new things to see and do.*

**ADULT 5:** *R is for READY, ready for new adventures together as a team.*

**ADULT 6:** *S is for SHARING, taking time to talk to each other about the fun things we get to do.*

## ◆ TIGER OPENING (OR CLOSING)

The Tigers and their adult partners stand in a circle and hold hands. In turn, each adult partner tells one thing the Tiger did since the last meeting to show that he did his best. End with everyone reciting the Cub Scout motto. (Tigers only)

# FLAG CEREMONIES TO OPEN AND CLOSE DEN MEETINGS

Most den meetings will include the Pledge of Allegiance to the U.S. flag. It is appropriate to have a presentation of the colors and the Pledge of Allegiance at the beginning of the den meeting, with the retirement of the colors at the conclusion. On occasion, you can vary the opening ceremony and not use the flag. Patriotic ceremonies should be meaningful and inspirational for boys.

## ◆ FLAG CEREMONY PLANNING

When you take the time to plan ahead, the Cub Scouts will be prepared for a successful experience.

- When younger Cub Scouts are responsible for a flag ceremony, make sure the flags are not too heavy for the boys to carry.
- Check the ceiling height beforehand to determine whether the flags will clear it. If they won't, post the colors before the meeting.
- Rehearse the ceremony. Make sure everyone knows his part and walking route.

## ◆ CREATE YOUR OWN OPENING CEREMONY WITH THE U.S. FLAG

Use the following suggestions to make your ceremony effective:

- Have the color guard post the colors and retreat.
- Post the flag, and then create a slight breeze with an electric fan.
- Shine a flashlight or spotlight on the flag.
- Follow the flag with a flashlight or spotlight while the color guard walks in.
- Use background music.
- Prerecord music and play it, making it louder or softer as your ceremony progresses.
- Use songs that are appropriate for the occasion, such as "The Star-Spangled Banner," "America, the Beautiful," "You're a Grand Old Flag," "God Bless America," seasonal songs, marching songs, or spiritual songs.

## ◆ FLAG CEREMONY COMMENTS

Keep in mind the following guidelines:

- When in uniform, stand at attention and salute with your right hand.
- When not in uniform, stand at attention and place your right hand over your heart. You should remove your non-uniform hat.
- When in uniform, with your head covered or uncovered and either indoors or outdoors, stand at attention and salute with your right hand when the U.S. national anthem is played, the colors are raised or lowered, the Pledge of Allegiance is recited, or the U.S. flag passes by in a parade.
- The color guards do not participate in saluting, singing, or saying the Pledge of Allegiance with the group because their job is to guard the flag at all times. They should salute after the U.S. flag is posted.
- The U.S. flag is posted on the left, as you look toward the front.
- Any person can write to his or her U.S. senator or U.S. representative and, for a reasonable fee, receive a flag that was flown over the U.S. Capitol in Washington, D.C.
- For more information regarding the U.S. flag, refer to the BSA booklet *Your Flag*.
- You can find additional information on the U.S. flag from government websites and from veterans' groups.
- Make sure that you include all boys in your flag ceremonies at different times of the year. Boys with physical disabilities can proudly act as narrator or even flag bearers when adults see these events as possibilities instead of barriers.
- Sometimes we hear people say the phrase "one nation (pause) under God." When this phrase was added by House Joint Resolution 243 and approved by President Dwight D. Eisenhower on June 14, 1954, it was added without a comma or pause after the word "nation." The correct phrasing is "one nation under God."

## ◆ STANDARD INDOOR FLAG CEREMONY USING FLAG STANDS

**Preparation:** Put flag stands in place at the front of the room. Looking to the front, the U.S. flag stand is on the left. Flag guards are in the back of the room holding the flags. They have already checked to make sure that the flags fit in the flag holders and that the flags clear the ceiling.

**Personnel:** Narrator and color guard

**Materials:** U.S. flag and a den flag if available

NARRATOR WILL CALL:	ACTIONS
<i>Attention. Will Scouts please rise.</i>	(Pause.) The color guard waits in the back of the room for the Scouts to stand and become quiet.
<i>Color guard, advance.</i>	The den flag guards and bearer are on the left, and the U.S. flag guards and bearer are on the right. With the U.S. flag in the lead, they walk in and cross so that the U.S. flag will be on the left side of the room when you look toward the front. The bearers and guards take their positions near the flag stands, facing the audience and holding the flags vertically.
<i>Hand salute.</i>	Everyone, with the exception of the flag bearers and guards, salutes.
<i>Please say with me the Pledge of Allegiance.</i>	All join in.  The bearers and guards stand at attention and continue to hold the flags. The den flag is lowered slightly so that the U.S. flag stands taller. The U.S. flag guards and bearer and den flag guards and bearer do not salute or say the Pledge of Allegiance.
<i>Two.</i>	The den drops its salute. The den flag is raised to its vertical position again.
<i>Color guard, post the colors.</i>	The den flag is placed in its stand. Its guards and bearer step back into place. The U.S. flag is then posted. Its guards and bearer step back into place. The U.S. flag is then posted.
<i>Color guard, dismissed.</i>	The U.S. flag guard leads the procession to the back of the room with the narrator following last.



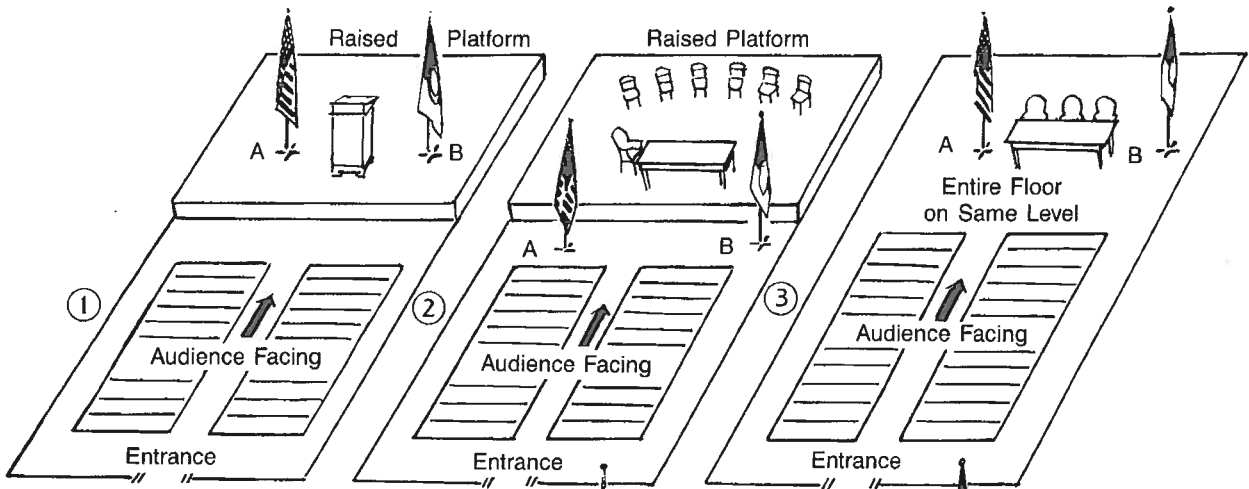

Note: A stands for the national flag, B stands for any other flag.

Diagrams 1-2-3-4 apply to lecture halls, classrooms, club rooms, churches, auditoriums, etc.

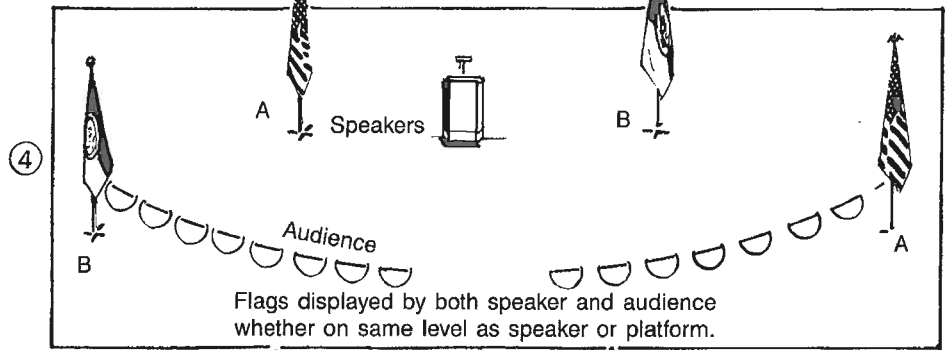

Flags displayed by both speaker and audience whether on same level as speaker or platform.

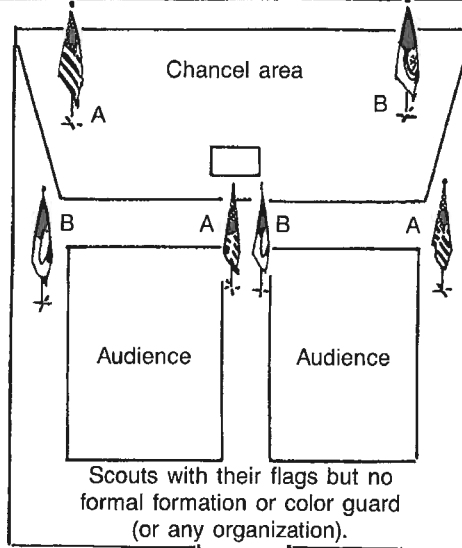
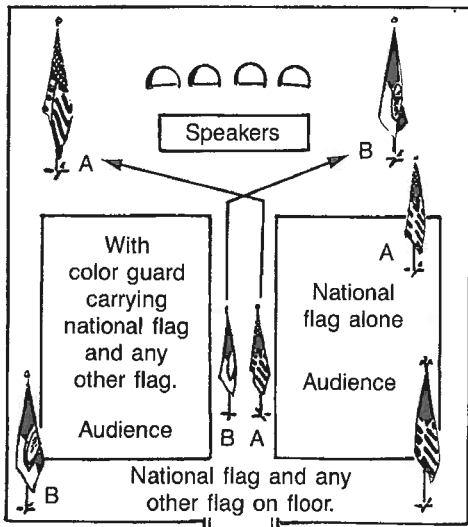

## ◆ RETRIEVAL OF COLORS INDOORS

NARRATOR WILL CALL:	ACTIONS
<i>Attention. Will Scouts please rise.</i>	(Pause.) The color guard waits in the back of the room for the audience to rise and become quiet.
<i>Color guard, advance.</i>	The U.S. flag guard and bearer and pack flag guard and bearer walk down the aisle and to the flags. They stand behind the flags, facing the audience.
<i>Color guard, salute.</i>	The guards and bearers salute.
<i>Color guard, retrieve the colors.</i>	The U.S. flag is removed first (just slightly ahead of the den flag).
<i>Hand salute.</i>	Everyone, with the exception of the guards and bearers, salutes. The U.S. flag stays on its "marching right" as the guards and bearers proceed down the aisle to the rear of the room.
<i>Two.</i>	Everyone drops the salute.

## ◆ STANDARD OUTDOOR FLAG CEREMONY USING A FLAGPOLE

**Preparation:** Check the flag against the rope to make sure the attachments line up before the flag ceremony. It helps to lower the loops to the base of the flagpole so it is ready for the ceremony. Rewind the cord to hold in place.

**Personnel:** Narrator and color guard

**Materials:** U.S. flag and a pack flag

Remember that the outdoor program runs like a thread through the Scouting program. When dens and packs are outdoors, ceremonies are appropriate—and important!

- Outside noises from wind and water can make it difficult to hear voices. Keep the group close together and have the speaker face the crowd.
- Plan your flag ceremony carefully. If you do not have a secure flag holder, have the boys present the flag and continue to hold it during your flag ceremony. Then have them retreat with the flag. Whether you are inside or outside, give the U.S. flag the same respect and handle it properly.
- Use nature as a backdrop. Look around and choose a location that showcases your event.
- Sweep the area and walkways, looking for loose rocks and tree roots that might trip a boy or adult.

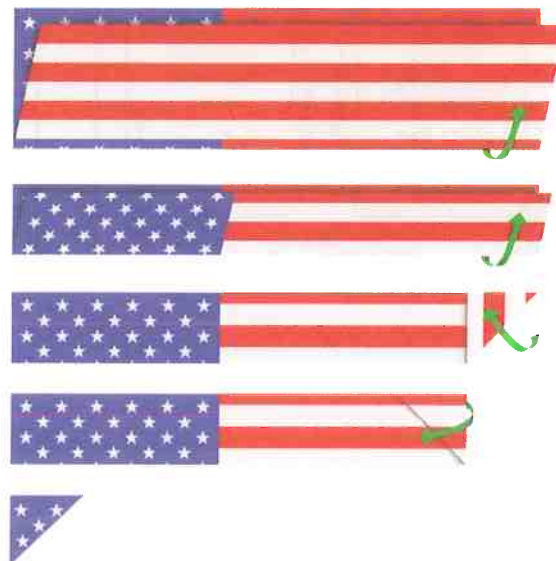

NARRATOR WILL CALL:	ACTIONS
<i>Attention. Will the audience please rise.</i>	(Pause while everyone stands and remains quiet.) The color guard waits in the rear for the audience to become quiet.
<i>Color guard, advance.</i>	The U.S. flag guards and bearer walk in and take their positions near the flagpole, facing the audience.
<i>Color guard, prepare to raise the colors.</i>	The line is unwound. The flag is unfolded and attached to the rope.
<i>Hand salute.</i>	Everyone, with the exception of the U.S. flag guards and bearer, salutes.
<i>Color guard, raise the colors.</i>	Then the flag is raised quickly to the top of the pole, and the cord is wound back in place.
<i>Please say with me the Pledge of Allegiance.</i>	The U.S. flag guards and bearer stand at attention. (All join in.) The U.S. flag guards and bearer do not salute or say the Pledge of Allegiance.
<i>Two.</i>	The den drops its salute.
<i>Color guard, salute.</i>	The U.S. flag guards and bearer salute.
<i>Color guard, dismissed.</i>	The color guard retreats to the back of the group.

#### ◆ RETRIEVAL OF COLORS—FLAGPOLE

NARRATOR WILL CALL:	ACTIONS
<i>Attention. Will the audience please rise.</i>	(Pause.) The color guard waits in the rear for the audience to become quiet.
<i>Color guard, advance.</i>	The U.S. flag guards and bearer walk to the flagpole. They stand behind the flag, facing the audience.
<i>Color guard, salute.</i>	The U.S. flag guards and bearer salute.
<i>Color guard, prepare to retrieve the colors.</i>	They unwind the cord and wait.
<i>Hand salute.</i>	Everyone, with the exception of the U.S. flag guards and bearer, salutes. The U.S. flag is quickly lowered.
<i>Two.</i>	As soon as the flag touches the hands of the guard, this command is given. Everyone drops the salute. The U.S. flag guard and bearer remove the flag from the rope and fold it correctly.
<i>Color guard, retreat.</i>	They return to the back of the group.

# TALK TIME SUGGESTIONS

This section of the meeting is set aside to cover the “business items” that need to be covered for den and pack activities in the near future. Some of these items will be covered every meeting, some may only be covered once a year.

It may be handy to have a prepared handout to send home with the Scouts or hand to their parents, especially if it involves logistics—such as meeting somewhere different for a tour or items the Scouts need to bring from home for the next meeting, etc.

## ◆ DUES

If your pack uses the dues you collected to fund your den operations, then you will need to come up with a system to collect them regularly and record who has paid and who has not. This is a perfect job for an assistant den leader, if you have one, or it could be taken care of by a parent who is willing to help. There are various ways to record the payments: a wall chart, a special colored bead on a “den doodle,” a den record book, or another method that works for you. Make it easy and simple so anyone willing to help can handle it. You may want to collect something every week or on a monthly basis. Some parents prefer to pay for the entire year so their Scout is taken care of. Decide how much (usually around \$1 a month), when you want to collect it, and how it will be recognized; then tell the Scouts’ parents so they are aware of your process.

Obviously, it will be important for you to keep good records of your den purchases and dues collections in case there are any questions. Some packs do not use individual den dues, but instead cover den expenses from the pack budget or sponsoring organization. You will need to find out how your pack handles this.

It may be convenient to collect dues as part of your Gathering activity time.

## ◆ ADVANCEMENT

Your Scouts may work on advancement with their parents as well as in your den activities. You may also assign them Do-at-Home Projects from time to time—items to finish at home and bring back to show the rest of the den. It may be convenient to record this information during this part of the meeting. An assistant den leader will work well for this duty as well.

You will need to have a method to record this advancement. The BSA sells colorful wall advancement charts that can be used to keep track of each of your Scouts’ adventures. Using colored pencils or a signature to designate a requirement as completed can work well with this type of chart. If your pack uses a computer-based tracker and you or an assistant are proficient in entering information on a laptop or other device, then it may work well for you to track advancement digitally. You can learn more about digital tracking with MyScouting on Scouting.org. There are also paper pages available from BSA and other sources to assemble a binder and mark off individual requirements.

However you decide to track advancement, it is an important part of your den leader job. Figure out a method that works for you, and go for it!

If a Cub Scout has completed an advancement item with his family or at school, have him give a short report to the rest of the den, so they can see that all advancement does not have to happen in the den meetings.

This may also work well in the Gathering activity time if you have help and the activity will not be interrupted.



## ◆ OUTINGS OR TOURS

Traveling with Cub Scouts and their families can be a lot of fun! It can also create opportunities for confusion and misdirection. It's very important that everyone involved has the information they need to have a great time.

Preparing a printed or electronic handout, flier, or brochure to give to the families with *ALL* the information needed will save you a lot of headaches. Depending on the trip, you may have a few items to pass along or a couple of pages. Here are some samples:



### Den 1 TV Station Tour!

Den 1 and their families will be touring TV station KCUB next Wednesday, May 14. We will be meeting at Tamkin School at our regular meeting time, 6:30 p.m., and then carpooling to the station together. The tour is free, but we will be stopping for ice cream at Dairy Village on the way home. Cones can be purchased for \$2, and of course, their full menu will also be available.

The station needs to know an approximate head count, so please contact me by Friday, May 9 with the number of family members attending. You can reach me by email at [dljanet@email.com](mailto:dljanet@email.com), or call 702-555-0111.

This should be a very interesting trip, and the Scouts will be completing our current adventure with this trip. Hope to see you all there!

DL Janet



### Flaming Arrow Den Spring Campout

ALOHA! The Flaming Arrow Webelos den will be holding our Spring Campout next month at the Rocky Willows Scout Camp near Random Lakes on June 10-12. The theme this year is "Hawaiian Luau"!

Cost for this event is \$15 per person, which will include all meals, supplies, and a cool patch! Webelos Scouts and their parents are invited to attend (no siblings on this trip). The fee is due on June 6 at the pack meeting.

We will meet at the camp. Attached is a map. The trip is about 20 miles and will take about 30 minutes.

Attached to this sheet is a gear list that each person will need. We have access to camping gear if you need to borrow sleeping bags or tents for your group. The weather is always a little cooler at the camp, so be sure to pack warm clothes.

We will be holding a planning meeting at 6:30 p.m. on May 20 at Spohn Elementary. Everyone planning on attending should be there. All of your questions will be answered!

The Webelos Scouts had a great time on this event in the fall, and are looking forward to another exciting weekend!

Any questions? Email [camperbob@email.com](mailto:camperbob@email.com), or call 702-555-0112.

Always be sure to provide all the important information you can, including:

- Dates
- Location
- Cost
- Transportation method
- Items needed
- A contact person

Try to put yourself in the place of new parents, and give them all the information they need to feel welcome and ready!

Here is a good extended version of a trip planner from the BALOO (Basic Adult Leader Outdoor Orientation) training. While you may not need to fill in all the blanks, it may help you uncover some holes in your planning.

# Cub Scout Outdoor Program Checklist

---

Date(s) \_\_\_\_\_

Location \_\_\_\_\_

BSA facility

Council-approved non-BSA facility

**I. Administration**

Tour and activity plan

Camp reservation made

Parent permission slips

Camp deposit/fee paid

Health forms

Local requirements

Insurance

Licenses and permits  
(fishing, boat, campfire, parking, etc.)

**II. Leadership**

Event leader \_\_\_\_\_ Phone (\_\_\_\_) \_\_\_\_\_

Assistant \_\_\_\_\_ Phone (\_\_\_\_) \_\_\_\_\_

Program leader \_\_\_\_\_ Phone (\_\_\_\_) \_\_\_\_\_

Assistant \_\_\_\_\_ Phone (\_\_\_\_) \_\_\_\_\_

**III. Transportation**

Driver	No. of seat belts	Driver License No.	Auto Insurance Yes/No
_____	_____	_____	_____
_____	_____	_____	_____
_____	_____	_____	_____
_____	_____	_____	_____
_____	_____	_____	_____

Equipment hauled by \_\_\_\_\_

**IV. Location**

Maps prepared \_\_\_\_\_

Assembly location \_\_\_\_\_

Departure time \_\_\_\_\_

Camp arrival time \_\_\_\_\_

Camp departure time \_\_\_\_\_

Anticipated return time \_\_\_\_\_

Stops en route (meal Y/N) \_\_\_\_\_

V. Equipment

Personal equipment lists

Program equipment

Group

Emergency

VI. Feeding

Menu planned by \_\_\_\_\_

Who buys food? \_\_\_\_\_

Fuel supplied by \_\_\_\_\_

Duty roster by \_\_\_\_\_

Food storage \_\_\_\_\_

VII. Sanitation \*

Special camp requirements \_\_\_\_\_

\_\_\_\_\_

VIII. Safety

Ranger contact

Phone (\_\_\_\_) \_\_\_\_\_

Nearest medical facility

Phone (\_\_\_\_) \_\_\_\_\_

Nearest town

Police number \_\_\_\_\_

First aid/CPR-trained leaders \_\_\_\_\_

\_\_\_\_\_

IX. Program

Program planned

Special program equipment needed

Item(s) \_\_\_\_\_ Provided by \_\_\_\_\_

Item(s) \_\_\_\_\_ Provided by \_\_\_\_\_

Item(s) \_\_\_\_\_ Provided by \_\_\_\_\_

Item(s) \_\_\_\_\_ Provided by \_\_\_\_\_

Item(s) \_\_\_\_\_ Provided by \_\_\_\_\_

Item(s) \_\_\_\_\_ Provided by \_\_\_\_\_

Item(s) \_\_\_\_\_ Provided by \_\_\_\_\_

Rainy day activities planned

\_\_\_\_\_

\_\_\_\_\_

\_\_\_\_\_



## ◆ COMMUNICATING THE PACK AND DEN CALENDAR TO PARENTS

Your pack will be holding some special events that may require additional help or more time to prepare than normal meetings. Some of these events might be:

**Blue & Gold Dinner:** Inviting other family members

**Pinewood Derby/Raingutter Regatta:** Distributing kits, holding workshops to help build the racers, running the race

**Pack Campouts:** Providing important information, gear needed, who can attend, what events will be happening, etc.

**Bridging Ceremonies:** Possible change in location, special guests invited, special ceremonies and inspiration

**Holiday Parties or other Celebrations:** Preparing decorations, songs, skits, treats

Additional events provide by the council or district such as:

- District pinewood derby
- Fun days at the park/ballgame/zoo/trail or other special “Scout only” events
- Day camp/resident camp/overnighters

These all need to be promoted at the den level so your Scouts can take advantage of the opportunities. You should be able to find out about them at roundtable or by talking to your unit commissioner.

## ◆ CUB SHARING TIME

Periodically, it is a good idea to let the Scouts share what’s happening in their lives—something fun they did with their families, a good thing that happened at school, a fun game they’ve learned, or a new toy or Scout gear they have acquired. Set up some ground rules, such as:

- Time limit per Scout, perhaps only one Scout per meeting
- Only positive, fun things—nothing derogatory or hurtful
- Props—do you want it to turn into “show and tell”?
- Topic—defined by you (favorite pet, favorite game, etc.), or let them decide
- Related to the Scout Oath or Scout Law—how they helped other people or did their best that week

It may be helpful to screen the first couple you do for the year, just to make sure they get off on the right track. This can be a lot of fun for you and the Scouts, and provide some insight for you into their lives.

## ◆ DENNER INVESTITURE

A denner is a member of your den who has been given special responsibilities for your group for a fixed period of time, usually a month. He will be given some jobs to do at the meeting, such as:

- Setting up games for the Gathering activity and then picking them up afterward
- Preparing a simple snack for the group, if you use one as part of your plan
- Setting up craft or activity items for the activity portion of the meeting
- General cleanup after the meeting
- Leading Opening and Closing ceremonies
- Keeping track of attendance records
- Other duties as the occasion arises

Talk Time is a great time to award the denner cord to your denner. The denner wears a denner cord over his left shoulder. The cord is removed at the end of the month, and presented to the new denner for his period of service. This responsibility mirrors leadership tasks the Scout will need for rank advancement in Boy Scouts. You should have specific tasks designated for the denner to do, and make sure he performs them.



## ◆ MEETING INFORMATION

Use a small portion of this time to tell the den what is going to happen tonight. Are you:

- Starting work on a new adventure?
- Finishing up one you've already started?
- Working on skills and projects for an upcoming pack event?
- Playing a new game?
- Learning a new skill?
- Preparing thank-you notes for people who have helped them out recently?

Set the stage for another exciting meeting! This will let them know what they're doing tonight AND it will show their parents that you have a plan and are working it! Be sure to include the reason for the activities in that night's meeting.

## ◆ GROUNDWORK FOR FUTURE ADVANCEMENT

If part of next month's adventure requires some homework that might take a little time to complete, let them know a few weeks early and keep reminding them—and their parents! This is probably a good time to send a flier or other announcement home so the parents have all the details on what is needed.

# CLOSING CEREMONIES

## ◆ BROTHERHOOD CIRCLE CLOSING

Form the den in a brotherhood circle. Each boy places his left arm around the shoulder of the boy on his left and his right arm around the shoulder of the boy on his right.

**Den leader or den chief:** *Now may the Great Master of all Scouts be with us until we meet again.*

## ◆ FLAG FOLDING CLOSING

Have three Scouts fold the flag while the other boys stand respectfully in a semicircle.

## ◆ FRIENDSHIP CIRCLE CLOSING

Den leaders and members form a friendship circle. Cross arms with right arm over left and grasp the hands of people on each side. They then sing a closing song.

## ◆ HANDSHAKE CLOSING

Have the boys form a circle and pass the Scout handshake from one to another around the circle until it reaches the boy who started it. As each boy receives the handshake, he silently makes a wish and pledges to do his best.

## ◆ LEADER'S MINUTE CLOSING

This is a closing inspirational thought. It can be a brief story about the Scout Oath, the Scout Law, the motto, or something patriotic. It could reflect ideals such as being kind to animals and people, showing sportsmanlike behavior, or participating in school activities. It is told without moralizing.

## ◆ LIVING CIRCLE CLOSING

Based on an American Indian custom, the living circle may be used alone or as a part of another ceremony. It reminds a Cub Scout of the fine friendships he is making in Cub Scouting.

Den leaders and den members form a close circle and turn to their right, each placing his left hand into the center of the circle, palm facing downward. Each person grasps the thumb of the person behind him, making a complete circle with the group. Everyone's right hand is held straight up in the Cub Scout sign. One version is to pump joined hands up and down seven times as all say, "Akela! We'll—do—our—best!" You can also use the Scout Oath, the Cub Scout motto, or your own personal words in place of this chant.



## ◆ MOUNTAIN CLIMBING CLOSING THOUGHT

Ask the boys to sit in a circle.

**Den leader:** *Picture a very high mountain. It is beautiful but very dangerous. It has slippery glaciers and high rocky places you can climb only with special equipment and with help from other people. Mountain climbers depend on each other. They must be able to trust their friends at the other end of the rope. When you pick your friends, think about whether this is a person you could trust at the end of that rope. Let's have a moment of silence as we think about the good friends we have chosen.*

## ◆ MY FLAG CLOSING

Right before the ending, the den leader asks each boy to write a sentence about what the U.S. flag means to him. For the closing ceremony, read the statements.

## ◆ PATRIOTIC SONG CLOSING

Den members form a circle around the U.S. flag. Everyone salutes and sings "America," "God Bless America," or another patriotic song. (See the *Cub Scout Songbook* for ideas.)

## ◆ SQUARE KNOT CLOSING

Give each boy a 3-foot section of rope. The boys tie their ropes together with square knots to form a complete circle. They all lean back carefully to form a taut circle.

**Den leader:** *You are part of a group of close friends, held together by the square knot—a symbol of friendship.*

## ◆ TIGER CLOSING SONG

Divide the singers into two groups. The first group sings the first verse. The second group responds with the second verse. Repeat, singing faster each time. This song could be adapted for other ranks. (Tune: "The Muffin Man")

*Can you find a Tiger,  
A Tiger, a Tiger?  
Can you find a Tiger  
With black and orange bold stripes?*

*Yes, we found a Tiger,  
A Tiger, a Tiger.  
Yes, we found a Tiger  
With black and orange bold stripes.*

## ◆ WE MEET AS CUB SCOUTS CLOSING

Have the boys form a circle.

**Den leader:** *We meet as Cub Scouts [Tigers, Wolves, Bears, Webelos Scouts], we part as friends, as now we leave, our meeting ends. Let this circle be a token of friendship, as Akela guides us home.*

# DEN OUTINGS

Excursions and field trips provide some of the most exciting parts of Scouting. Cub Scouts enjoy many outdoor experiences as they participate in the variety of activities that can be held outside, such as field trips, hikes, nature and conservation experiences, and outdoor games.

## ◆ OUTINGS

Boys enjoy visiting museums, business establishments, parks, and other attractions. Here are some suggestions:

**How Things Are Made:** Visit manufacturing plants such as aircraft, automotive, appliance, or electronic manufacturers; chemical, paper, plastic, paint, furniture, or toy plants; and handicrafts or other small-craft industries.

**How Your Community Runs:** Visit power, water, and sewage plants; a gas company; police and fire stations; city hall; municipal buildings; the county jail; a telephone company; the post office; the Red Cross; hospitals; newspaper plants; and radio, television, and weather stations.

**How Your Community Is Fed:** Visit truck and dairy farms, flour mills, and bakeries; food processing, canning, or bottling plants; stockyards and meat or poultry packing houses; a fish hatchery; beverage, candy, and ice-cream companies; markets; and food distributors.

**Learn About Your Culture and Heritage:** Visit art galleries, museums, and memorials; celebrated old homes, monuments, and other historic sites; places of worship; civic centers; important local buildings; summer theaters and band concerts; and local historical celebrations.

When these field trips are coordinated with the Cub Scouting adventures, they can help bring learning to life by allowing boys to experience firsthand the things they have been learning about.

## ◆ HIKES

A hike is a journey on foot, usually with a purpose, a route, and a destination. All ranks in Cub Scouting will have several opportunities for taking hikes related to specific adventure requirements. See the Outdoor Appendix for more information on hikes.

## ◆ PLANNING DEN OUTINGS AND EXCURSIONS

When planning a trip or excursion for your den or pack, keep the following guidelines in mind:

- Make sure that all activities are age-appropriate. Especially for pack excursions, which include boys of various ages, make sure there's something that appeals to everyone.
- While it's OK to include some activities just for the fun of it, make sure the featured event of an excursion relates to the monthly theme or activity badge.
- Refer to the *Guide to Safe Scouting* (BSA No. 34416) to ensure that all activities are conducted in a safe manner. The online version, which will always be the most current, can be found at [www.scouting.org/HealthandSafety/GSS/toc.aspx](http://www.scouting.org/HealthandSafety/GSS/toc.aspx).
- Be sure to file the proper forms and permits. A tour and activity plan (No. 680-014) is recommended whenever the den travels to a place other than its regular meeting place (even for short in-town trips) and an activity consent form (permission slip) should be signed by the parent or guardian of every boy. The tour and activity plan and the activity consent form can be accessed at [www.scouting.org/HealthandSafety/TourPlanFAQ.aspx](http://www.scouting.org/HealthandSafety/TourPlanFAQ.aspx)

# APPENDIX 2

## WORKING WITH BOYS

### BOY BEHAVIOR

Positive behavior is a great responsibility and, sometimes, challenge for the den leader. It isn't easy—but it isn't impossible, either. Remember that each boy (just like all of us) has emotional needs that need to be fulfilled. These needs include being accepted, getting noticed, belonging, receiving praise and encouragement, feeling safe and sound, letting off steam, expressing himself, experimenting (and making some mistakes in the process), and having fun.

How each boy tries to fulfill these needs is what makes him unique. One boy may be timid and quiet, and another, loud and rowdy; but both are afraid they won't be accepted. Den leaders must plan ahead and be prepared to make Cub Scouting a positive experience for every boy and his family.



### HOW TO ACHIEVE POSITIVE BEHAVIOR

The den meeting is a time when the den leader and Cub Scouts socialize, practice what they've learned at home, and plan for future activities. For the den meeting to be productive for everyone, it must run smoothly. A good atmosphere is essential to managing boys' behavior. Many times, that simply means recognizing and rewarding good behavior. Here are some suggestions for encouraging good behavior.

#### ◆ EXPECTATIONS

Be sure that every boy and his parent or guardian understand the purposes of Cub Scouting, the advancement system, the structure of the den and pack, and the expectations of both boy and parent in the program. A letter to parents and guardians with a follow-up face-to-face meeting within a couple of days of their son joining Cub Scouts will ensure this.

Den leaders should be sure to wear their uniforms to strengthen a visual connection between the leader and the boy. The uniform serves as a reminder for boys to be on their best behavior.

#### ◆ CODE OF CONDUCT

A code of conduct is a list of behavioral expectations and consequences if the code is broken. Boys, with the den leader's guidance, usually create it themselves. Three or four points will be sufficient, and they should be positive; the words *no* or *don't* have no place in a code of conduct. Include a final rule such as "Have fun!" Also consider including the 3 R's: Respect for others, Responsibility for yourself and your things, and Reasonable behavior. Boys should sign the code of conduct, and it should be displayed at every den meeting. Using the 12 points of the Scout Law can serve as a strong foundation for a code of conduct, and also reinforce the values of Scouting.

#### ◆ TWO-DEEP LEADERSHIP

A minimum of two registered adult leaders, a registered leader and an adult parent or guardian of a participating Cub Scout—one of whom must be at least 21 years old or older—is required for all trips and outings. Two-deep leadership can also be invaluable in managing boys and their activities during den meetings. With two leaders, an energetic den can be divided into two groups, or one leader can work with a boy who is having difficulty keeping up or managing his behavior. Furthermore, a second adult provides another pair of hands when projects require adult help.

## ◆ THE DEN CHIEF

The den chief is a wonderful resource for the success of a den. Although the den chief is not part of the two-deep leadership because he is not an adult, he can help manage the den by being prepared with a game, story, stunt, song, or other brief activity that provides some variety in the den program. See the *Cub Scout Leader Book* and *Den Chief Handbook* for more information on den chiefs.

## ◆ DEN MEETING STRUCTURE

Following the den meeting structure as outlined in this den leader guide will go a long way to making a meeting run smoothly. Every part of the den meeting structure plays a vital role in the success of the meeting.

## ◆ LEADER/SCOUT RELATIONSHIP

The relationship between a leader and the Scouts is central to managing the boys' behavior. For instance, if the den leader enjoys the den meeting, the boys will, too. The boys model what they see, so be a good model by having a positive attitude.

- **Be consistent and fair** in all your dealings with boys. Treat them the same when they break any rules. But do this in a manner that allows a boy to keep his dignity. Give him a chance to tell his side of the story. Allow him the opportunity to apologize. He will be aware of and remember your kindness and caring. Your example of fairness will carry over into other aspects of the boys' lives.
- **Be a good listener.** When a boy wants your attention, look him in the eye. If you are busy, look him in the eye and ask him to wait a minute. Honor his patient waiting by turning to him with your full attention as soon as possible.
- **Give each boy a chance to participate in discussions.** To encourage boys to speak one at a time and to listen carefully, you might try a "talking stick," an American Indian tradition. Only the person holding the talking stick is allowed to speak, and everyone else must listen respectfully without interrupting. A talking stick can be a dead branch from a tree, a dowel rod, or even a shortened broomstick handle. Let the den members decorate the talking stick so that it represents them and they value it. Use markers, paints, or stickers to enhance the stick. Boys may want to hang feathers, beads, or shells on leather strips from their talking stick.
- **When you notice a boy's good behavior, comment on it!** Let him and the others in the den know exactly what you liked. Soon, you'll have all the den members copying that behavior. Comments such as "I like the way you kept trying," or "Good thinking," or "Now you have the hang of it" encourage and build self-esteem. The more specific you are, the more likely the communication has been effective and the activity will be repeated.



# TRACKING BEHAVIOR

Keeping track of behavior helps a boy and his leader know how he is doing. Here are some suggestions.

## ◆ CONDUCT CANDLE

Use the same candle each week. The denner lights the candle at the beginning of the den meeting, and the candle is allowed to burn as long as all den members show good behavior. But if a boy misbehaves or breaks the code of conduct, the candle must be blown out for the rest of the meeting. As soon as the candle burns down, the den is entitled to a special outing or special treat.

## ◆ TICKETS

Buy tickets at teacher or party supply stores, or make them yourself by hand or with the use of a computer. Give boys a ticket when they do something good. (Try to give each boy an opportunity to receive a ticket during a meeting.) They write their names on the back of their tickets. The tickets are placed in a jar, and a drawing is held at the end of the den meeting for a small treat (gum, candy, stickers, small toy, etc.). At the end of the month, hold a drawing for a “big” winner.

## ◆ MARBLE JAR

Use a glass jar so it makes lots of noise when you put a marble in. Draw a line on the jar high enough so that it will take the boys six weeks or so to earn enough marbles to fill it to that point. Explain that when marbles reach the line, the den will get a treat. Drop a marble in the jar when someone in the den does something good. Make a production out of it. Celebrate with the den when they reach their goal.

## ◆ STICKERS AND CERTIFICATES

Give big flashy stickers to boys for good behavior. Use them only occasionally, or they lose their appeal. Make certificates by hand or with a computer. Use gold seals or other decorative stickers. You can also purchase certificates at teacher supply stores.

## ◆ SUPER STAR PINS

Decorate clothespins, one for each boy, with stars. As you notice a boy’s good behavior, pin one on him. At the end of the meeting, boys with pins on can pick something from a “treat bag” filled with food items (candy, granola bars, popcorn, bags of chips or cookies, etc.) or inexpensive items that appeal to boys (baseball cards, small toys, pencils). Vary the items in the treat bag often.

## ◆ SUPER STAR NOTES

These notes to parents and guardians are good for praising the boy when he gets back home. You can make your own by hand or with a computer or buy them at a teacher supply store. The boy will know you really appreciate it if you tell his family how well he did.

## ◆ COUP STICK

Some American Indian tribes used coup sticks (“coo sticks”) as a way to display accomplishments. Items such as beads, feathers, bear claws, or eagle claws were awarded at tribal meetings for deeds of note (not unlike badges Cub Scouts earn!). These were attached to the coup stick for display, bringing honor to the coup stick owner.

Make a den coup stick by drilling a hole through a wooden dowel at the top and bottom. Loop a long piece of heavy-duty string or leather cord through the holes so it runs the length of the dowel. Award small items at den meetings for good behavior. Use beads, feathers, stamped leather pieces, stamps on poster board pieces, etc., and attach them to the string on the coup stick. Take the coup stick to pack meetings to bring honor to your den!



# DEN DOODLES AND DEN FLAGS

## ◆ DEN DOODLES

A den doodle is a clever way to record advancement progress and other accomplishments of the boys as well as a colorful decoration for the den meeting place. It can be something as simple as a chart, much like the den advancement chart, or it can be a simple structure consisting of a cutout mounted on a stand. No two den doodles are alike.

With the boys' help, choose a design that "fits" the den. Den doodles can be made from wood, cardboard, foam board, or other materials; they can be a tabletop or floor design; or they can hang on the wall or from the ceiling. Include the den's number and a place for each boy's name and advancement record or accomplishment.

Add something to the den doodle at each meeting, recognizing attendance, proper uniforming, and behavior as well as completed achievements toward rank. Colored beads and shells slipped onto leather lacing are common items for symbols of progress. Identify each symbol with an achievement or elective number or activity badge name.

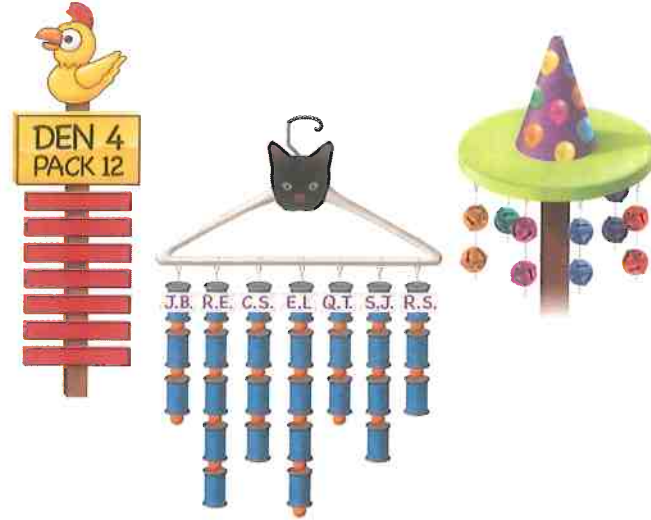

Dens may earn simple awards (sometimes called dingle dangles) for a variety of things, such as perfect attendance, good behavior, participation in service projects, or responsibilities at the pack meeting. For example, the den leading the flag ceremony at the pack meeting or at school might earn a small flag to hang on their den doodle; the den that leads a song might earn a musical note made of felt. You can find more examples of den doodles in *Cub Scout Ceremonies for Dens and Packs*.

## ◆ DEN FLAGS

Den flags are simple flags that represent each den and give den members a sense of camaraderie and identification. The flag is blue and yellow with the den number on it. Den flags are available from the BSA Supply Division. The flag may go home with a different boy after each meeting or may be the responsibility of the denner for the month. The flag should be brought to each pack meeting and mark the place where the den sits.

## ◆ BASES FOR DEN DOODLE OR DEN FLAG

Make bases from wood or from a 2-pound coffee can filled with plaster, as shown. Cover the end of the flagpole with aluminum foil and grease with a thick layer of petroleum jelly so it will slip out easily after the plaster hardens. Or use a piece of PVC pipe that has an opening slightly larger than the diameter of the flagpole. Cover the bottom end of the PVC with foil and set it into the wet plaster. It should stick several inches out of the plaster. When dry, the pole will slip easily into the PVC pipe.

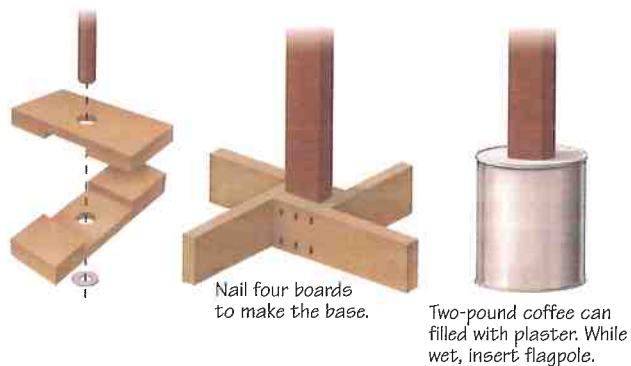



## DEN LEADER “SURVIVAL” KIT

At times, even the best plans go awry. A bag packed as a leader “survival” kit comes in handy when chaos has erupted, all your planned activities for the meeting have been exhausted, or the den just needs a change of pace. Your survival kit will grow as you and your den work together and discover the things the boys like best—you will base your survival kit on those activities. The goal is to pack your bag with lightweight, multiple-use objects—and take it to every den meeting.

Here are some suggestions for your leader survival kit. Remember that each item should have multiple uses. Newspapers, for example, can be rolled and taped to become bats or batons to pass during a relay; left flat, they can become a “base” for use during a game; opened, they can act as a drop cloth for messy projects; folded, they can become hats. Newspapers can also be torn and taped and shaped into instant costumes. Your imagination is the only limit.

- Balls—a couple of tennis balls and at least one soccer ball
- Blindfolds—at least two
- Safety pins
- Duct tape
- Newspapers
- Markers, pens, pencils, chalk
- Blank paper, various colors
- Lightweight rope
- Scissors
- Balloons
- Empty 16-ounce drink bottles with caps—at least six
- Magic tricks
- Puzzles

## GUIDELINES FOR SPECIFIC TYPES OF SPECIAL NEEDS AND DISABILITIES

Every boy has needs. Three important ones are to feel accepted by a group, to feel a sense of competence as he approaches a task, and to feel a sense of self-satisfaction at its completion.

For some boys, these needs are easily met. For others, it takes a little more thought and planning on the part of leaders to help the boys. The parents or guardians of a boy with special needs will be the best resource for information about their son’s abilities, limits, and goals. Other resources include the boy’s teachers and the *Cub Scout Leader Book*.

Many people wonder how a boy who is different from other members of the den will be accepted. You will find that with proper preparation of the den, these boys are accepted into the fellowship of the den easily.

If a Cub Scout has any of the following disabilities, these ideas might be helpful. Always ask if he needs, or wants, help. Ask *how* you can help.

### ◆ MOBILITY IMPAIRMENTS

- Remember that people who use adaptive equipment (wheelchairs, crutches, etc.) often consider their equipment an extension of their bodies.
- Never move equipment out of the person’s reach.
- Before you go out with someone who has a mobility impairment, make sure facilities at the destination are accessible.
- Never pat a person in a wheelchair on the head. This is a sign of disrespect for adults.
- When helping, ask how equipment works if you are unfamiliar with it.
- Prevent strained necks by standing a few feet away when talking to someone in a wheelchair.
- Find a place to sit down for long talks.

## ◆ HEARING LOSS

- Make sure the person is looking at you before you begin to talk.
- Speak slowly and enunciate clearly.
- Use gestures to help make your points.
- Ask for directions to be repeated, or watch to make sure directions are understood correctly.
- Use visual demonstration to assist verbal direction.
- In a large group, remember that it's important for only one person to speak at a time.
- Speakers should never stand with their backs to the sun or light when addressing people with hearing loss.
- Shouting at a person who is deaf very seldom helps. It distorts your speech and makes lipreading difficult.

## ◆ VISION IMPAIRMENTS

- Identify yourself to people with vision impairments by speaking up.
- Offer your arm, but don't try to lead the person.
- Volunteer information by reading aloud signs, news, changing street lights, or warnings about street construction.
- When you stop helping, announce your departure.
- If you meet someone who has a guide dog, never distract the dog by petting or feeding it; keep other pets away.
- If you meet someone who is using a white cane, don't touch the cane. If the cane should touch you, step out of the way and allow the person to pass.

## ◆ SPEECH/LANGUAGE DISORDERS

- Stay calm. The person with the speech disorder has been in this situation before.
- Don't shout. People with speech disorders often have perfect hearing.
- Be patient. People with speech disorders want to be understood as badly as you want to understand.
- Don't interrupt by finishing sentences or supplying words.
- Give your full attention.
- Ask short questions that can be answered by a simple yes or no.
- Ask people with speech disorders to repeat themselves if you don't understand.
- Avoid noisy situations. Background noise makes communication hard for everyone.
- Model slow speech with short phrases.

## ◆ COGNITIVE DISABILITIES

People whose cognitive performance is affected may learn slowly and have a hard time using their knowledge.

- Be clear and concise.
- Don't use complex sentences or difficult words.
- Don't talk down to the person. "Baby talk" won't make you easier to understand.
- Don't take advantage. Never ask the person to do anything you wouldn't do yourself.
- Be understanding. People with below-average cognitive performance are often aware of their limitations, but they have the same needs and desires as those without the disability.

## ◆ SOCIAL/EMOTIONAL IMPAIRMENTS

People with social/emotional impairments have disorders of the mind that can make daily life difficult. If someone is obviously upset,

- Stay calm. People with mental illness are rarely violent.
- Offer to get help. Offer to contact a family member, friend, or counselor.

## ◆ AUTISM SPECTRUM DISORDER

Here are some tips for leaders.

- Provide consistent, predictable structure. Be patient. Allow extra time for activities.
- Provide a visual schedule with words and pictures. All Scouts will find this useful. Don't put times in the schedule because a Scout with autism may expect you to follow it to the minute!
- Let the Scout know about transitions early by saying, "In five minutes we'll be ending this activity and starting another."
- Give the Scout information about new activities ahead of time.
- Break up tasks into smaller steps.
- Alert the Scout's parents if there is going to be an activity that may cause sensory difficulties for their son. Consider moving noisy activities outside where the noise can dissipate. If the Scout has issues with food taste and texture, carefully plan the menus around these issues so the Scout can eat the same things as other members of the unit as much as possible.

## ◆ ATTENTION DEFICIT DISORDER

Leaders can have a positive effect on children with attention deficit disorder (ADD). Here are some ways leaders can help.

- Structure Scout meeting time, activities, and rules so that the Scout with ADD knows what to expect. Post a calendar of events.
- Be positive. Praise appropriate behavior and completion of tasks to help build the Scout's self-esteem.
- Be realistic about behavior and assignments. Many children with ADD simply can't sit for long periods or follow detailed instructions. Make learning interesting with plenty of hands-on activities.
- Monitor behavior through charts and explain expectations for behavior and rewards for reaching goals. This system of positive reinforcement can help the Scout stay focused.
- Begin a formal achievement program. Weekly reports to parents could increase their involvement.
- Work closely with parents and members of the education team. People working together can make a big difference.
- Be sensitive to the Scout about taking his medication. Avoid statements such as, "Johnny, go take a pill."
- Simplify complex directions. Give one or two steps at a time.

## ◆ LEARNING DISABILITIES

Learning disabilities (including minimal brain damage, perceptual abilities, communication disorders, and others) are usually disorders of the central nervous system that interfere with basic learning functions.

- Listen and observe carefully to find clues as to how this Scout approaches problems and what his difficulties are.
- Remember that praise and encouragement can help build self-esteem.
- Let other den members use their friendship and support to show the Scout that he belongs.
- Use short, direct instructions that help the Scout know what is expected of him.
- As much as possible, stay with a regular den schedule, allowing the Scout to help with assigned duties.
- Give the Scout extra time when needed. Don't rush his answers. Rephrase instructions if necessary.
- Introduce and recite new materials (such as new songs or the Scout Oath and Scout Law) together as a group. Provide repeated opportunities for Scouts to practice and learn them.

# APPENDIX 3

## CRAFTS

### WHY WE USE CRAFTS

As Cub Scouts work on craft projects, they not only learn to make useful items but also get valuable experience in using and caring for basic tools and materials, learning to follow directions, using their imaginations, and developing coordination and dexterity. Craft projects can be used for advancement requirements or just for fun.

Making his own craft project calls for creativity in each boy. As he embarks on his project, he may need to measure, trace a pattern, cut or saw, sand, and assemble a project with nails, screws, or glue. Crafts develop boys' ability to understand and satisfy their urge to experiment. Furthermore, physical development and mental growth are by-products of the craft program. Muscle coordination comes from lifting, moving, sawing, drilling, hammering, and pounding. Painting helps improve arm and hand control. Folding, cutting, shaping, filing, and sanding craft materials help develop eye and hand coordination.

As boys work with crafts, they learn to shape materials into useful articles. While decorating them, they also learn that useful things can be beautiful art. They gain confidence to experiment with materials and tools and learn new ways to do things. A completed craft project enables each boy to shout out "I did my best!"

### TEACHING CRAFTS TO CUB SCOUTS

The leader's job is to stimulate each boy's interest and curiosity and to encourage him to try. It is important to allow the boy to create and be proud of his creation. He is making more than just "things"; he is building his mind, body, and future.

All Cub Scout leaders have different backgrounds and experiences, so their knowledge of craft techniques and tools will vary. Those with limited experience may enlist parents and other adults to teach specific techniques or to provide materials and tools.

The *Cub Scout Leader Book* provides some excellent tips for leaders working with boys on craft projects. In addition, the following steps will help leaders teach crafts:

1. Choose a project with the help of the boys. Make sure the project is something that has a purpose and that they will enjoy making.
2. Make a pattern, if needed. Have enough pattern pieces available so that boys don't have to wait to trace them.
3. Make a sample to show the boys, but remember: These are age-appropriate crafts for boys, so don't go overboard and make your sample too elaborate.
4. Gather enough materials and tools so everyone can work at the same time.
5. Teach the craft step by step:
  - Cut out parts, as required.
  - Put them together.
  - Finish it (sand, polish, paint, etc.).
  - Clean up.
6. Whenever possible, start a craft in a den meeting that boys can finish at home with family help. Be sure, however, that the family is aware of the responsibility and has any instructions and materials necessary.
7. Display the craft projects at a pack meeting.



Leaders should guard against crafts that are simply “busywork” of the “cut-and-paste” type that are below the boys’ abilities and interests. Crafts should be more than mere handwork: They should be a creative outlet and a form of expression, as well as a way to learn skills. By relating crafts to the monthly theme, you give each boy a chance to live a new dream each month and to create the costumes, props, and other items to help make that dream a reality. Sometimes, leaders think they need to have a craft project at every den meeting. But remember that crafts are only one of many activities used to accomplish the purposes of Cub Scouting. Overemphasizing crafts may discourage boys whose interests and abilities lean in other directions.

## HELPING THE BOY WITH CRAFTS

- Encourage the natural creative urge in each boy. If you don’t, the urge may disappear and be replaced by lack of confidence in his own abilities.
- Through praise, you can help the boy build self-confidence in his abilities.
- Learning by doing is important.
- Show enthusiasm for the boy’s progress. Don’t be overly critical.
- Show him how—but don’t lose patience and take a tool away from him because you can do it better or faster. This will discourage him and destroy his self-confidence.
- Be patient. Remember: Boys may have to be shown over and over how to use a tool.
- Be tactful. Offer your help during difficult parts of a job by saying, “Let’s work on this part together.”

## RESOURCES FOR CRAFT MATERIALS

Materials for crafts should be simple and inexpensive. In most cases, you can find scrap materials for crafts around the home. Most communities have many resources for craft materials. Although you may have to purchase some specialized items at craft and hobby stores, you can acquire most through salvage and surplus or donation.

Check telephone directories and begin looking for places where you might be able to obtain aluminum foil, burlap, canvas, clay, cord, floor covering, leather and vinyl scraps, nails, paper bags, plastic rope, sandpaper, spools, etc.

Here’s a “starter” list of possible resources for craft materials. Most of the sources listed have scrap that is available for the asking, or at minimal cost. Keep your eyes and ears open for the endless list of “beautiful junk” available for recycling into Cub Scout crafts.

- **Lumber Company:** Wood scraps, sawdust, and curls of planed wood may be given away by the boxload. Make your contact and request, and then leave a marked box to return and pick up later.
- **Grocery Stores:** Check grocery stores for boxes of all sizes and shapes. Discarded soft drink cartons are excellent for holding paint cans.
- **Telephone Company:** Empty cable spools make great tables; use old telephones as props for skits; use colorful telephone wire for many different projects.
- **Soft Drink Company:** Plastic soft drink crates may be available at a minimal charge. Use them for storage or for projects. Also, use plastic six-pack rings for various projects.
- **Ice Cream Stores:** Use empty 3-gallon cardboard containers for wastebaskets and storage.
- **Medical Laboratories:** Ask for clean paraffin and tongue depressors.
- **Gas Stations and Garages:** Tires and bike tubes are great for games and obstacle courses.
- **Wallpaper Stores:** You’ll find wallpaper sample books of discontinued patterns.
- **Carpet Stores or Outlets:** Discontinued rug samples and soft foam under-padding can add to craft projects.
- **Tile Stores:** Use broken mosaic tiles for many craft projects.
- **Appliance Stores and Furniture Stores:** Large packing crates are handy for skit props and puppet theaters.

- **Newspaper Companies:** Ask about end rolls of newsprint.
- **Printing Companies:** You can never have too much scrap paper and cardstock.
- **Pizza Restaurants:** Cardboard circles are good for making shields and other craft projects.
- **Upholstery Shops and Drapery Shops:** You'll find a wide variety of fabric and vinyl scraps.
- **Picture Framing Shops:** Leftover mat boards make great awards or bases for other projects.

## ◆ USING SALVAGE

Many items that are destined for the trash can be used for Cub Scout craft projects. Ask families to be on the lookout for scrap materials. If you live in a community that has a manufacturing company nearby, you may be surprised at the scrap wood, plywood cutoffs, and odd pieces of metal, cardboard, leather, and plastics that you can get just by asking. Ask families to save things such as tin cans; the cardboard rolls inside paper towels, toilet paper, and wrapping paper; boxes; tree branches; plastic bottles; buttons; cloth; pinecones; and wire hangers.

Here's a partial list of useable scrap materials:

- Bottle caps—for Christmas tree ornaments, foot scrapers, wheels, construction projects, markers for games
- Bottles—for musical instruments, containers
- Broom handles—as dowels for projects
- Cardboard cartons—for construction projects, stage props, puppet stages, storage
- Catalogs—for decorations, designs, cutouts
- Clothespins—for human figures, fastening items together, games
- Coat hangers—for wires for mobiles and other constructions, skeletons for papier-mâché work
- Coffee/juice cans—for storage, planters, games
- Coloring books—for patterns for nametags, etc. Patterns can be enlarged for craft projects.
- Corrugated cardboard—for stage props and scenery, bulletin board, shields, swords
- Ice cream cartons (3-gallon)—for trash cans, drums, masks
- Ice cream spoons—for mixing paint, spreading paste, figures
- Jars—for containers for paint, paste, and brushes; decorate them for gifts.
- Juice-can lids—for tin punch projects, awards
- Leather or vinyl scraps—for key chains, bookmarks, neckerchief slides, coin purses
- Macaroni—for stringing for jewelry, pictures, and frames
- Margarine tubs—for storing small objects (lids can be used like flying saucers in games)
- Newsprint—for covering tables, papier-mâché, flip chart, growth charts, large backgrounds and scenery
- Old shirts or pajama tops—for paint smocks (cut off the sleeves), costumes
- Paper bags and old socks—for hand puppets
- Paper plates—for plaques, masks, games
- Paper towels—for papier-mâché, cleanup
- Pipe cleaners—for simple sculptures
- Plastic water bottles and milk jugs—for planters, games, costumes
- Shelf paper—for finger painting
- Soap bars—for carving
- Sponges—for painting, printing, cleanup
- Straws—for holiday decorations, party favors, games
- Tin cans—for metal work, storage containers, planters

- Tongue depressors and craft sticks—for mixing paint, modeling tools
- Wallpaper—for book covers, paper for painting
- Wrapping paper—for murals, painting
- Yarn—for hair for wigs and puppets, holiday ornaments

### ◆ TIPS FOR PAINTING

**Acrylics:** Jar acrylic is more economical, but acrylic paint is also available in tubes. It can be thinned with water. Brushes clean easily with water. Acrylics are nontoxic, good for painting almost anything, and don't need a finishing coat.

**Tempera:** Water-based paints such as tempera are great for Cub Scouts. Powdered paint is more economical but messier. Mix powdered tempera with water and add a little liquid starch, which helps the paint go further and not run.

**Cleaning Brushes:** Different paints need different cleaners. For tempera, poster paint, or acrylics, use water. The boys can clean up after using these paints; adults should supervise cleanup for other media. To clean varnishes, oils, or enamels, use turpentine, mineral spirits, or kerosene. For shellac, use shellac thinner. For model paint, use the recommended thinner. For lacquer, use lacquer thinner. These solvents are flammable and should be used outside and well away from sparks and flames. Adequate ventilation is required when working with any of these paints or solvents.

**Finishing Coats:** Objects painted with tempera or poster paint will have a dull finish and will not resist moisture. For a shiny finish and for protection, spray with clear plastic or clear varnish, or finish with a coat of diluted white glue. Acrylic paint does not need a finishing coat.

**Paintbrush Substitutes:** For large items such as scenery, use a sponge dipped in tempera. For small objects, use cotton swabs.

**Painting Plastics:** For painting plastic milk containers or bottles, mix powdered tempera with liquid detergent instead of water or starch. The paint will adhere better.

**Painting Plastic Foam:** Some types of paint will dissolve plastic foam, so only use one that is recommended. Test it first on a scrap.

**Painting Wood:** It is best to give raw wood a coat of wood sealer or thin shellac before painting to prevent the paint from soaking into the wood.

**Spray Painting:** A spray bottle works well for spray painting large items. Use diluted tempera or poster paint. If using commercial spray paints, be sure to read the label and follow any instructions.

### ◆ TIPS FOR ADHESIVES

- To save money, buy white glue in quart sizes and pour into small glue containers for the boys.
- To make heavy-duty glue, mix cornstarch with white glue until the mixture is as thick as desired.
- For small glue jobs, put glue in bottle caps and let boys use toothpicks or cotton swabs.
- Clear silicone is the best glue for plastic bottles and milk containers. It is available at hardware stores and requires adult supervision.
- Egg white is a good adhesive for gluing kite paper. It is strong and weightless.
- Tacky white glue is the best adhesive for plastic foam. A little goes a long way.
- Wheat paste (wallpaper paste) is a good paste for papier-mâché. Flour and water make a good paste too.
- Masking tape and cellophane tape can be used successfully in many projects.



# APPENDIX 4

## GAMES

### WHY WE USE GAMES

Games are part of all the fun of Cub Scouting. Skills and interests boys develop now teach self-confidence, independence, and the ability to get along with others. Children learn through play.

For these reasons, games are an important part of Cub Scouting. Games not only help to accomplish Cub Scouting's overall objectives of citizenship training, physical fitness, and character development, they have educational benefits, too. Games teach a boy to follow rules, to take turns, to respect the rights of others, to give and take, and to play fair. Some games help boys to develop skills, body control, and coordination. Some teach self-confidence and consideration for others. Games stimulate both mental and physical growth, as well as providing an outlet for excess "boy energy."

### HOW TO CHOOSE GAMES

When choosing a game, you should consider three things: the physical aspects, mental values, and educational values of the games as they relate to Cub Scouting.

Consider first the physical aspect: the release of surplus energy. An active game should be satisfying to the strongest boy and yet not overtax the weakest. It should stimulate the growth and development of muscles. Most outdoor games meet this test.

Boys of Cub Scout age are growing rapidly. They like to run, jump, climb, lift, balance, crawl, bend, yell, chase, and hide. Generally, long walks or runs and other exercise involving endurance are not as suitable for boys of this age. (Also, boys who have had recent severe illness should not take part in active games.)

Some games are selected for their mental values because they have an element of excitement or accomplishment. Games can help boys develop quick thinking, alertness, and strategy. Many games offer boys opportunities to express their feelings and emotions, which is healthy.

Boys need to learn to play fair and to follow the rules. They also need to learn that they can't always be winners. Many boys of Cub Scout age have not yet learned to lose gracefully. Your task as leader is to make it clear that losing a game is not the end of the world and that a loss should be an incentive for the boy to try to improve his skills.

Some games are selected for their educational value. Boys' minds are more receptive to learning when learning is fun. Their interest and concentration are probably never higher than during play. Games are a way to help boys learn that rules and self-discipline are necessary and that doing one's best is important. Most Cub Scout games help in character development because they require teamwork, fair play, and consideration for others.

Consider these factors when choosing games:

- Purpose (physical, mental, educational)
- Space available
- Number of players
- Equipment available
- Skills and abilities of players

Whether the game involves group competition with team winners or individual competition or is just for fun, the results should be positive and lead to building character and helping boys grow and develop.



# SUGGESTIONS FOR LEADING GAMES

Boys will like most games if leaders have fun leading them. Anyone can be a successful games leader by following these simple suggestions:

- Know the rules of the game and have the necessary equipment on hand. Plan not only what you are going to do, but how you are going to do it.
- Start with your best game—one that is easy to explain and enjoyable to play. In addition to bolstering your own confidence, a successful game can enhance the morale of the players.
- Make sure the space available is large enough so everyone can play. Mark off boundaries for active outdoor games with brightly colored cones.
- Remove potential hazards from the play area. Follow health and safety rules.
- Get the full attention of the group and then explain the rules of the game simply, briefly, and in proper order. Be enthusiastic.
- For team games and relay races, you must have equal numbers of players on each team. If the teams are unequal, one or more boys on the smaller team must compete or race twice.
- As a rule, Webelos Scouts are larger and stronger than first-grade Tigers and second- and third-grade Cub Scouts. For some pack competitions, have boys in the same grade compete against each other, but not against older or younger boys. With this method, several winners can be recognized.
- An alternative is to mix the groups so that each team has boys from each age or grade.
- Remember to adapt your game to meet the needs of any Scouts with special needs.
- Teach the game by steps or through demonstration.
- Ask for questions after explaining and demonstrating the game.
- Be sure boys follow the rules. Insist on good sportsmanship and fair play.
- If the game is not going right, stop it and explain the rules again.
- Don't wear a game out. Quit while the boys are still having fun.
- Have enough leaders to handle the group.
- Keep It Simple; Make It Fun (KISMIF).

Teach games to boys with the hope that they will be able to play and lead these same games independently in other settings, such as at school or in the neighborhood.

Coach your den chief in leading games. This will enhance his leadership role. Find creative ways to develop leadership skills among the boys so that they may soon be able to play on their own without the assistance of a den leader or den chief.

## CHOOSING “IT” AND TEAMS

There are many ways to choose the boy who will be “It” for any game. Here are some suggestions, but make up others that work for your group.

- By birthdays, starting with January 1
- By alphabet, using first or last names
- By drawing a name out of an “It” box. After a name is drawn, it goes into a second box marked “It.” When all names are in the second “It” box, put them back in the first box to begin again.

When choosing teams, try one of these ideas:

- Even-numbered birthdays against odd-numbered birthdays
- First half of the alphabet against the last half
- Drawing names from a box. Each boy decorates a craft stick with his name on it and any other creative artwork he wishes. When you need teams for a game, pull out two sticks and put them in separate piles. Continue to pull out pairs of sticks, separating them into two piles, which will be your teams. When you are finished, replace all the sticks so they will be ready for the next team game.

You can also make a game of choosing sides. Have boys sit in a circle and then whisper in each boy’s ear the word “Wolf” or “Bear.” Then they must make the appropriate animal sound to find the other members of their team.

## COOPERATIVE GAMES

Cooperative games emphasize teamwork and creative thinking as players face a particular challenge. Leadership opportunities within the group often arise during play. Cooperation between group members is essential. Everyone “wins” as they help and cheer each other on to a successful outcome.

In general, cooperative games:

- Include questions that have no expected solution; thus there is no “right” or “wrong” answer.
- Stimulate one’s imagination and thinking process.
- Emphasize playing rather than being eliminated from the competition.
- Are fun!

## MAKING GAMES COUNT— LEADING REFLECTIONS

A reflection is a discussion led by a leader that helps Scouts learn from games and other activities. It is helpful and important to ensure that Scouts and leaders learn this process well in order to benefit most from it. As their time in Scouting continues, reflections will be led by experienced Scouts for other Scouts.

Reflection really includes two processes—thinking about what occurred and making sense of it. Reflection helps to integrate the experience into life. This is how we learn from experience. A reflection can help young people see how the skills they use to overcome challenges when playing games are the same sort of skills that they can use to overcome challenges in life.

Facilitate the discussion. As a leader, avoid the temptation to talk about your own experiences.

Reserve judgment about what the Scouts say to avoid criticizing them. Help the discussion get going, then let the Scouts take over with limited guidance from you. If you describe what you saw, be sure your comments don’t stop the participants from adding their own thoughts. Above all, be positive. Have fun with the activity and with the processing session!

Use thought-provoking questions. The following types of questions are useful in reflecting:

- **Open-ended questions** avoid yes and no answers. “What was the purpose of the game?” and “What did you learn about yourself?”
- **Feeling questions** require participants to reflect on how they feel about what they did. “How did it feel when you started to pull together?”
- **Judgment questions** ask the participants to make decisions about things. “What was the best part?” or “Was it a good idea?”
- **Guiding questions** steer your Scouts toward the purpose of the activity and keep the discussion focused. “What got you all going in the right direction?”
- **Closing questions** help Scouts draw conclusions and wrap up the discussion. “What did you learn?” “What would you do differently?” “How might you use this skill in other settings?”

Reflecting on an activity should take no more than 4–5 minutes for Tiger-aged youth. For older Cub Scouts, the reflection may last up to 10 minutes. The more you do it, the easier it becomes for both you and your Scouts. Remember that the value and values of Scouting often lie beneath the surface. Reflection helps you ensure that these values come through to your Scouts.

It is very important to use open-ended questions during reflections. Your goal is to help young people learn from their experiences. Rather than direct a Scout to specific outcomes (e.g., “Did it make you feel bad?”), allow him to come to his own understanding of the activity. The use of closed questions and asking/telling children what they are experiencing with an initiative game and the reflection that accompanies it will undermine the value of the process.

The sequence below is a helpful way to organize the questions you pose during the reflection. You want to have your participants identify (1) the purpose of the activity, (2) the challenges they encountered while taking part in the activity, and (3) what they might do differently next time (how to better apply the skill for greater future success).

Questions	Responses to elicit
<b>Focusing Questions</b>	<i>What did you do?</i>
What was the purpose of the game?	Have participants identify the specific actions they were to undertake. The answer should be as concrete and specific as possible.
<b>Analysis Questions</b>	<i>What did you do? or, How did you do it?</i>
Ask questions that help them analyze the success or challenges they encountered while playing the game. The questions should help frame the challenges they experienced in the game or activity around actions—and not around people. Later in Scouting, they will analyze obstacles to success in terms of leadership skills that games help them explore.	Seek to elicit answers to identify challenges in completing the task and how a particular obstacle was overcome.
<b>Generalization Questions</b>	<i>How will you use what you learned?</i> <i>How can participants use this skill more effectively?</i>
What will happen next time the group encounters obstacles related to the application of this skill?	The Scouts should demonstrate the ability to generalize from the challenges encountered in the game or activity to “real world” applications of the skill.

# GAMES

## ◆ ACTIVE GAMES WITH EQUIPMENT

### BALLOON BATTLE ROYAL

**Activity Level:** High

**Needed:** Any number of players, balloons, string

Arrange Cub Scouts in a large circle, each with an inflated balloon tied to his ankle. On a signal, players try to break all other balloons by stamping on them, while not letting their balloon get broken. When a balloon is broken, that player leaves the game. The game continues until only one player is left.

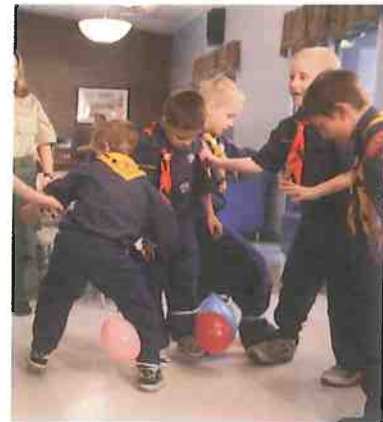

### CAT'S TAIL

**Activity Level:** Moderate

**Needed:** Even number of players; pieces of cloth or yarn, different colors for each team

Divide the group into two teams. Hide several pieces of cloth or yarn—a different color for each team. One boy on each team is a Cat Without a Tail. On a signal, all players search for “tails” of their color. As each is found, it is tied to the belt of their Cat. The winner is the team whose Cat has the longest tail at the end of five minutes.

## ◆ ACTIVE GAMES WITHOUT EQUIPMENT

### BEAR IN THE PIT

**Activity Level:** High

**Needed:** Any number of players

Boys form a circle. One player inside the circle is the Bear. While the others hold hands tightly, the Bear tries to get through the ring by force or by dodging under their arms. He may not use his hands to break the grip of the players in the ring. When he does break through, the others try to catch him. The first one to tag him is the next Bear.

### SHERE KHAN (THE TIGER GAME)

**Activity Level:** High

**Needed:** Large room or outdoor area, any number of players

One boy is Shere Khan, the tiger, and stands in the center of the playing area. All others line up against a wall. The object of the game is to cross to the opposite wall without being tagged. To start the game, Shere Khan says, “Who’s afraid of Shere Khan?” The others answer, “No one,” and immediately run across the open space toward the opposite side. All boys tagged help Shere Khan tag the remaining players in the next round. The last one tagged becomes Shere Khan the next time.

*Variation:* With a big field and a large number of players, half can be Shere Khans and half men. This game is also known as Pom-Pom Pullaway.

## ◆ BALL GAMES

### BUCKETBALL

**Activity Level:** High

**Needed:** Large room or playing area; even number of players; ball; two baskets, boxes, buckets, etc., for goals

This basketball-type game can be played with any type of ball that bounces and a couple of large containers such as laundry baskets, bushel baskets, or large wastepaper baskets. Place the baskets (goals) about 60 feet apart (closer if necessary because of space). Divide boys into two teams and play using basketball rules. No points are scored if the ball doesn't remain in the basket or if the basket turns over.

### MONKEY IN THE MIDDLE

**Activity Level:** Moderate

**Needed:** Medium-sized playing area, three players, playground ball or volleyball

Three players play this game. Choose one to be the Monkey. The other two players stand about 10 feet apart while the Monkey stands between them. The two end players toss the ball back and forth, trying to keep it high enough or moving fast enough so the Monkey can't catch it. If a player fails to catch the ball, the Monkey can scramble for it, or he can intercept it as it is thrown back and forth. If the Monkey gets the ball, he changes places with the player who threw the ball.

## ◆ BICYCLE GAMES

### BIKE RELAY

**Activity Level:** Moderate

**Needed:** Large paved area, even number of riders, bike and helmet for each rider

Establish a starting line and mark off turning lines about 50 feet away in opposite directions. Divide the group into two teams. The teams will ride in opposite directions. The teams should be about 20 feet apart to avoid collisions as the riders return to the start-finish line. On a signal, the first rider on each team races to his turning line and back. The next rider may not start until the first rider's front wheel has crossed the line. Continue until all have raced.

### COASTING RACE

**Activity Level:** Moderate

**Needed:** Large paved area, any number of riders, bike and helmet for each rider

The object of this race is to see which rider can coast the longest distance. Each rider pedals as hard as possible for a set distance (at least 15 feet) to a starting line, and then must stop pedaling and coast as far as he can. Mark the spot where a rider's foot touches the ground. The next rider tries to better that mark.



## ◆ KNOT GAMES

### GIANT SQUARE KNOTS

Two Webelos Scouts hold the free ends of a 10-foot-long rope in their right hands. Working together, they try to tie and tighten a square knot without letting go of the rope.

### KNOT CARD GAME

Separate the den into groups. The leader hands to each group a set of cards. On each card is the name of a knot, hitch, or lash that the den has learned. The first group with all the knots, hitches, and lashes correct wins.

## ◆ NONCOMPETITIVE, COOPERATIVE, AND TEAM-BUILDING GAMES

### BATTING DOWN THE LINE

**Activity Level:** Low

**Needed:** Large indoor or outdoor playing area, any number of players, inflated balloons

Two or more groups may play this game simultaneously. Arrange groups in parallel lines with members spaced about 2 feet apart. On a signal, the first player bats the balloon with either hand toward the person next to him, who bats it to the next, and so on until the balloon reaches the end of the line. If the balloon touches the ground, a group member must take it to the starting line, and the group members must begin again. Try varying the spacing between players. Is it more challenging to play the game with people closer together or farther apart?

### BLANKET BALL

**Activity Level:** Low

**Needed:** Indoor or outdoor area, any number of players, two sheets or blankets, two balls or large soft objects (even rolls of toilet paper work well)

Form two groups. Group members grab hold of a blanket's edges, with a ball in the center of the blanket. Players practice throwing the ball up and catching it by moving the blanket up and down in unison, trying to get the ball as high as possible. After the groups have developed some skill in catching their own ball, they toss the ball toward the other group to catch on their blanket. Groups continue throwing the balls back and forth. Group members might reflect on how they decided to toss the ball to the other team.

*Variation:* Try using water balloons outdoors on a hot day.

## ◆ PARACHUTE GAMES

### PARACHUTE VOLLEYBALL

Place a small (6- to 10-inch) playground ball in the middle of the parachute. Players distribute themselves evenly around the rim of the chute, with the players along one half being team A and the others, team B. The object is for one team to flip the ball off the parachute on the other team's side to score a point. The high scoring team after a certain time, or the first team to attain a certain score, wins.

*Variation:* Keep a running tabulation of the scores instead of individual team scores. Play several times to see how low the score can be after a predetermined length of time.

### THE UMBRELLA

Players grasp the parachute waist-high using an overhand grip, making sure the hole of the parachute is on the ground. On the count of "one," everyone flexes his knees to a squatting position. On the count of "two, three, and UP!" everyone stands and raises arms overhead, pulling the parachute up and over their heads. As the chute billows out, the players will be pulled to their tiptoes and their arms will be stretched high in the air. The parachute is allowed to remain aloft and then slowly settle back to the ground. This can be done from a sitting or kneeling position—or even from wheelchairs.

## ◆ RELAYS AND RACES

### BALLOON SWEEPING RELAY

**Activity Level:** High

**Needed:** Even number of players, balloons, brooms

Arrange teams in parallel lines. Place an inflated balloon on the floor in front of each team. Give the first boy in each team a broom. On a signal, he sweeps the balloon to a turning line and back and then hands the broom to the second player, who repeats this action.

### BALLOON KANGAROO JUMPING

**Activity Level:** High

**Needed:** Any number of players, balloons

Boys line up side by side, each with an inflated balloon between his knees. On a signal, boys hop to the other side of the room and back to the starting line. The one finishing first wins. If a boy breaks his balloon, he is out of the race. If a boy drops his balloon, he must replace it between his knees before he can keep going.

## ◆ PHYSICAL FITNESS ACTIVITIES

### CIRCLE HOP

Draw a circle about 6 feet in diameter and stand two boys inside it. They face each other with their arms folded and one leg extended in front. On a signal, they try to upset or force each other from the circle by using the extended leg. They may hook or lift with the leg but must not touch their opponent with any other part of the body. Kicking or pushing with the uplifted leg is not permitted.

### CRAB WALK

From a squatting position, boys reach backward and put their hands on the floor without sitting down. They walk forward, keeping their heads and body in a straight line.



## ◆ QUIET GAMES WITH EQUIPMENT

### CLIP IT

**Materials:** Small dish with paper clips for each team

Each team has a small dish filled with paper clips. On a signal, the first person joins two paper clips together and passes the dish and beginning of the chain to the next person. That player adds another clip to the chain and passes it on. After a set time (five to eight minutes), the paper clip chains are held high in the air to see which team has the longest. This can be a good game to play at a blue and gold banquet, with each table having a dish with paper clips.

### BLOWBALL

**Materials:** Small table or large box, table tennis balls

Boys sit at a table small enough so they are close together. Put a table tennis ball in the center of the table. On a signal, the players, with their chins on the table and their hands behind them, try to blow the ball away from their side of the table. If the ball falls on the floor, return it to the center of the table and continue.

## ◆ QUIET GAMES WITHOUT EQUIPMENT

### ABOVE AND BELOW

Boys stand in a circle. One at a time, call out the names of things that are found either above or below the ground. For example, strawberries grow above the ground; potatoes grow below the ground. When you call the name of something that is found above the ground, the players stand; if it is found below the ground, they sit down. A player is eliminated if he responds incorrectly. The last player to remain in the game wins.

*Variation:* Call out the names of things that fly and crawl.

### ELECTRIC SQUEEZE

Boys form a circle and hold hands, with "It" in the center. One player starts the "shock" by squeezing the hand of one of the boys next to him. That player passes it on. The shock may move in either direction. "It" watches the faces and hands of the players, trying to spot the location of the shock. When he guesses correctly, the player caught becomes "It."

## ◆ HOMEMADE GAMES

### HOMEMADE RING TOSS

Invert a shallow cardboard box and push old-fashioned clothespins (not the spring-type) through the cardboard. Mark each pin with a number of points. Boys toss rubber, metal, or plastic rings from a distance away.

### TEETERBOARD JOUSTING

Make two teeterboards as shown (24 inches in diameter with 4-inch-high rockers). Make the padded jousting poles from plumber's suction cups, soft rubber balls, and squares of cloth. Place the boards so that the players are just within reach of each other. Each "knight" tries to push his opponent off his board. When any part of a knight's body touches the floor, he is beaten. *Only pushing is permitted; do not permit swinging or hard thrusting of the poles!*

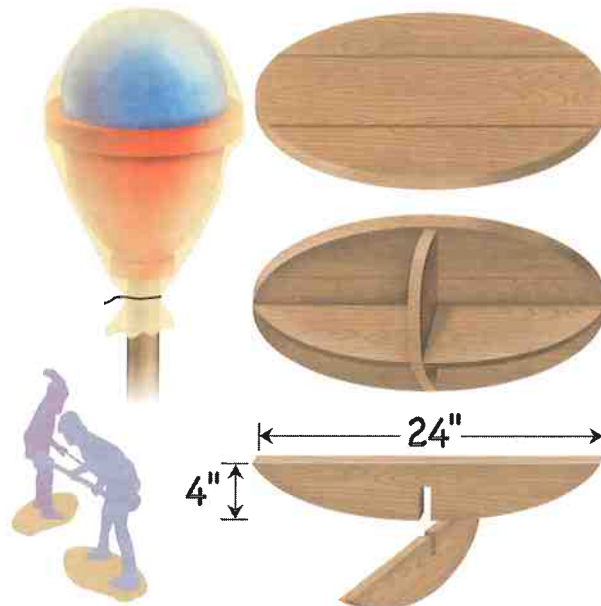

## ◆ TIRE GAMES

### ROLL FOR DISTANCE

Each boy rolls his tire as hard and as fast as he can up to a stopping line. The player whose tire rolls the farthest wins.

### TIRE ROLLING RELAY

Form two teams and give the first boy on each team a tire. Place a stake or chair opposite each team on a turning line. On a signal, the first player rolls the tire to the turning line, around the stake or chair, and back to his team to the next player.



## ◆ WATER GAMES

### UP AND UNDER

**Swimming Ability Level:** Nonswimmers and up

**Materials:** Playground ball

Dens line up in relay formation in waist-deep water. The first boy on each team has a large ball. On a signal, he passes the ball overhead to the second player, who passes it between his legs to the third, who passes it overhead, and so on to the end of the line. The last player runs to the head of the line and passes it as before.

### CORK RETRIEVE

**Swimming Ability Level:** All boys should be of the “Swimmer” ability level.

**Materials:** Ample supply of corks or wooden blocks

Scatter a dozen or more corks or blocks of wood on the far side of the pool. On a signal, boys jump in and try to retrieve the corks, bringing them back to the starting point one at a time. The boy with the most corks wins.

### LIVE LOG

**Swimming Ability Level:** All boys should be of the “Swimmer” ability level.

Establish a goal at one end of the pool. One boy is the “log.” He floats on his back in the center of the pool. The others swim around him. At any time the “log” may roll over and begin chasing the others, who race for their goal. Any player who is tagged becomes another “log,” and the game resumes. Continue until there is only one player left who has not been tagged.

## ◆ WINTER GAMES IN THE SNOW

### FOX AND GEESE

**Needed:** Freshly fallen snow on an open playground

In a large flat area, make a circle about 30 yards in diameter in the snow. Inside, make crisscrossing paths in any direction. Some may be dead ends. Where the paths cross in the center, make a safe zone. Make more than one circle, depending on the number of players, and make sure the circles are connected. One player (the Fox) chases the others (the Geese), but all must stay on the snow paths. When the leader says “Go,” the Fox chases the Geese, trying to tag one of them. A Goose can’t be tagged while standing in the safe zone, but if another Goose wants to use the safe zone, the first Goose must give it up. When a Goose gets caught by the Fox, he becomes the new Fox.

### SNOWBALL SHARPSHOOTING

**Materials:** Old sheet or blanket or piece of cardboard, clothespins, scissors

Hang an old sheet or blanket on a clothesline with plenty of clothespins. Cut three or four holes in the sheet, each 8 to 12 inches across. Boys stand 12 to 15 feet away and try to throw snowballs through the holes. Each snowball that goes through a hole is worth one point. If boys are real sharpshooters, have them move farther away to throw.

*Variation:* For Tigers or younger boys, use a hula hoop as the target. Suspend it from a tree or clothesline. A player could hold the hoop and use it as a moving target, slowly moving up or down as the other boys aim and shoot.

# APPENDIX 5

## OUTDOORS

Outdoor activities are an important part of Cub Scouting. Boys learn to appreciate and care for the beautiful environment all around them as they hike, explore, and investigate the world. The Cub Scouting outdoor program is a foundation for the outdoor adventure boys will continue to experience when they move on to a Boy Scout troop.

All Cub Scouts should have opportunities to enjoy the outdoors. Remember: You don't need to go far to share the wonder of nature with children. There are many opportunities for everyone to have outdoor experiences—even just in the neighborhood. Also remember that Cub Scouts with special needs can often enjoy outdoor activities with only minor modifications to the activity.

### WHAT TO DO IF LOST

Have boys learn the following suggestions, which can be learned with the visual cue of a stop sign:

#### **S – T – O – P!**

**S = Stay calm.** Stay where you are. Sit down, take a drink of water, and eat a little trail food. Stay where you can be seen. Don't hide! You are not in trouble!

**T = Think.** Think about how you can help your leaders or others find you. Stay where you are, and be sure people can see you. Make yourself an easy target to find. Remember, people will come to look for you. Stay put, be seen, and help them find you!

**O = Observe.** Listen for the rest of your group or people looking for you. Blow your whistle three times in a row, then listen. Three of any kind of signal means you need help, and everyone will try to help you.

**P = Plan.** Stay calm, stay put! Plan how to stay warm and dry until help arrives. Don't worry, you will be found.



### HEALTH AND SAFETY

The health and safety of boys, leaders, and families must be one of the first considerations in planning any outdoor activity. Try to anticipate and eliminate hazards—or at least warn against them. Most accidents can be prevented. The *Guide to Safe Scouting* should be the primary resource for safety policies and procedures, and the most current version is available online at [www.scouting.org/HealthandSafety/GSS/toc.aspx](http://www.scouting.org/HealthandSafety/GSS/toc.aspx). Additionally, see the *Cub Scout Leader Book* for outdoor safety rules, and see Safe Swim Defense (swimming) and Safety Afloat (boating) information at [www.scouting.org/HealthandSafety/GSS/gss02.aspx](http://www.scouting.org/HealthandSafety/GSS/gss02.aspx) and in the Aquatics section of the Appendix.

Also, follow these tips when planning and conducting an outdoor activity:

- Always get permission from parents or guardians for activities that are held away from the regular den and pack meeting places. Better yet, take the families with you!
- Be sure to have enough adult leaders for the activity planned. Always follow the policy of two-deep leadership.
- Check out the site before the activity. Find out about gathering places, restroom facilities, and safe drinking water. Look for hazards such as poison ivy.
- If applicable, get permission from the owner to use the property.

- Use the buddy system to prevent anyone from getting lost. Coach the boys in advance about what they should do if they get lost (see above).
- Carry a first-aid kit and know how to use it. Know basic emergency first-aid procedures.
- File a tour and activity plan with your local council service center two weeks before any den outing or campout.
- Have adequate and safe transportation.
- When leaving the site, take everything you brought with you. Leave the site in its natural condition.

## FUN ON HIKES

When did you last watch a colony of ants scurrying about as they worked hard? Or investigate a hollow tree? Or travel an unbeaten path? These are just a few things that you and the boys can do when you go hiking. The fun lies in observing everything around you as you hike, and while observing, talking about what you see. Enjoy nature—but *don't remove growing things from their natural habitats*.

You can hike in your own neighborhood or a nearby park, or you can travel to an out-of-the-way location. Or go to a nature center. Many nature centers include wheelchair-accessible trails so all boys can participate.

There are many types of nature hikes, some of which include nature activities. Several nature hikes are described here. See the *Cub Scout Leader Book* for other types of hikes and for hiking safety rules.

*Note: Always use the buddy system on hikes for safety and to prevent anyone from getting lost. Buddies should remain together at all times.*



# TYPES OF HIKES

## ◆ SEASONS HIKE

**Materials:** Pencils and crayons, notebooks for data collection, field guides

Choose a hiking area that you can hike in each season of the year. Each season, boys make a list of things they see along the way. Have them draw a particular area along the trail and how it changes. Which things remained the same each season? How many things changed as the seasons changed? (It's a good idea to collect and keep the boys' notebooks between seasons.)

## ◆ WEB OF LIFE

**Materials:** Pencil, paper

Animals, plants, and habitats rely on each other and form a "web of life." The soil nourishes the tree; the tree shelters the animal; the animal dies and adds nutrients to the soil. Everything in nature is affected by the many other things living around it.

Boys draw 12 small circles on paper where the numbers would be on a clock face. In each circle they draw or write the name of something they see along the hike. Encourage them to include different types of things: rocks, animals, plants, river, etc. Then have them draw a line from one circle to everything it affects or is affected by it. Continue doing the same with the other 11 circles. They have now created a web of life for this area. Was there anything that didn't have lines and didn't affect anything else? What would happen if you covered up one of the circles and it was gone from your area? How many other things would its absence affect?

## ◆ TRACKS AND SIGNS

Be a keen observer whenever you are out in nature. Look for all types of signs of animals and birds. Identify bird and animal tracks. Make plaster casts of animal tracks.

## ◆ MICRO HIKE

**Materials:** Strings 3 to 5 feet long

Lay strings out along an area to study. Boys cover the string trail inch by inch on their stomachs, with their eyes no higher than 1 foot off the ground. They may see such wonders as grass blades bent by dewdrops, colorful beetles sprinkled with flower pollen, powerful-jawed eight-eyed spiders, and more. Ask questions to stimulate their imaginations: "What kind of world are you traveling through?" "Who are your nearest neighbors?" "Are they friendly?" "Do they work hard?" "What would life be like for that beetle—how would it spend its day?"

## ◆ NATURE SAFARI

**Materials:** Field guides, pencils, paper

This hike will help boys learn to identify animals. See how many different species each boy can see on this local safari.

## ◆ SENSE OF TOUCH

This hike will illustrate the many textures of nature. Make sure that boys are instructed to examine the objects they find, not take them. Examples of what the boys may look for:

- The hairiest leaf
- The roughest rock
- Something dry
- The softest leaf
- The roughest twig
- Something warm
- The smoothest rock
- Something cool
- Something bumpy

Ask questions such as: “What did you find that was dry? Why was it dry?” “How might it be different tonight? Next summer/winter?” “How did it get there?” “Does it belong there?” “Did people have anything to do with it being there?” “Has it always been the way it is?”

## ◆ NATURE BABIES

Look for “nature babies”—birds, ferns, leaves, snails, insects, etc. How are the babies protected? How are they fed? Do not touch baby birds or animals. Look only from a little distance. Most babies that seem abandoned by their parents really aren’t. Mother or father may be nearby.

## ◆ HEADS-TAILS HIKE

**Materials:** Coin

Toss a coin each time you reach a crossroads. Turn left if the coin turns up heads, right if the coin is tails.

## ◆ NATURE NOISES

This is a great way to help boys notice and enjoy the sounds around them. Stop along the hike at different points. Boys sit or stand very still and listen. As they hear a new sound, they raise their hand as a signal. They can “collect” different sounds on their fingers, holding up a finger for each sound they hear. Can you count to 10 in between sounds? Listen for birds, animals, wind in the trees, falling leaves, or rushing water.

## ◆ COUNT THE COLORS

**Materials:** Crayons, paper, pencils

Each boy selects five crayons and colors an area on a piece of paper with each crayon. Take the paper on a hike and write each object found that matches the colors. Write them under the colored area on the paper. Ask boys how many colors they can see without moving from where they are.

## ◆ INCH HIKE

**Materials:** Small rulers

Find as many objects as possible that are 1-inch high, long, etc. Use the small rulers to measure. This helps boys notice the small things that they might otherwise overlook.

## ◆ A-B-C HIKE

**Materials:** Pencils, paper

Write the letters of the alphabet vertically on a piece of paper. On the hike, find an object, sound, or smell in nature for each letter and write it down.

### ◆ STRING-ALONG HIKE

**Materials:** 36-inch piece of string

Take the piece of string on your hike. Every now and then, place the string in a circle on the ground. See how many different things you can find enclosed in the circle. Then stretch the string in a line and see how many different things touch it.

### ◆ SURPRISE BREAKFAST HIKE

**Materials:** Breakfast fixings for everyone

Make arrangements ahead of time with the parents of your boys to go on a “surprise” hike. Pick the boys up at their homes and head out on an early-morning hike, cooking (or providing) breakfast outdoors.

### ◆ NIGHT HIKE

In areas where it is safe to walk at night, try a hike after dark. See how different things look, smell, and sound at night. Don't use flashlights, as they will lessen your ability to see and reduce your awareness of what is happening in the dark. Carry flashlights for emergency use only.

### ◆ SILENT HIKE

This hike can be difficult to accomplish but powerful in helping boys appreciate the world around them. Calm the boys by having them sit alone and a few feet apart for a short period of time. On the den leader's signal, the group begins to move along the trail tapping shoulders and pointing to share the sights and sounds of the hike. No talking!

## HIKING GAMES

While out on a hike you might want to stop to have a rest, enjoy lunch, or play a game. Here are some ideas for activities while taking a hiking break.

### ◆ KNOW YOUR ROCK

**Materials:** Tape, pencil, rocks found on your hike

Each boy finds a fist-sized rock, remembering where he found it so he can return it after the game. All sit in a circle with eyes shut, holding their rocks. Tell them to “get to know” their rocks by the feel, texture, smell, etc. After a few minutes, collect the rocks, mix them up, and redistribute them. The boys pass the rocks around the circle and try to identify their own rock with their eyes still shut. To help prevent any disagreements, affix a small piece of tape to each rock with the owner's initials. Be sure to remember to remove the tape when you leave the rock behind!

### ◆ KNOW YOUR LEAF

**Materials:** Leaves

This is similar to Know Your Rock. With eyes open, each boy gets to know a leaf by its shape, size, color, veins, etc. Then put all leaves in a pile and let one boy at a time try to find his, explaining to the group how he did it and what he looked for.

## ◆ GRAB BAG

**Materials:** 15 items from nature, 15 small paper bags

Collect 15 items from nature, such as pinecones, nuts, shells, etc., and place each in a small paper bag. Pass the bags around the circle of boys and let them try to identify the object by feeling the outside of the bag.

## ◆ NATURE PHOTOGRAPHER

Boys work in buddy pairs, with one boy acting as the “camera” and the other as the “photographer.” The photographer guides the camera, who has his eyes closed, to an interesting nature picture. When the photographer is ready to “take the picture,” he taps on the camera’s shoulder to signal him to open and close his eyes. The photographer can “adjust” his camera to take tight- and wide-angle shots and to use interesting angles and perspectives. The camera and photographer should talk as little as possible to enjoy this experience. The photographer should also remember to guide his camera safely. After several pictures have been taken, it will be time for the photographer and camera to switch positions and begin again.

## ◆ NATURE KIM’S GAME

**Materials:** Nature items, towel or jacket

Gather nature items such as pinecones, leaves, twigs, rocks, etc. Place them in an area for the boys to study. After a few minutes, cover the items with the towel or jacket and have the boys try to remember all the now-hidden items.

## ◆ CAMOUFLAGE TRAIL

**Materials:** 15 or 20 human-made objects

This game can open doors to a discussion about how an animal’s color can help protect it. Along an area of trail, place 15 or 20 human-made objects. Some objects should stand out and be bright colors. Some should blend in with the surroundings. Keep the number of objects a secret. Boys walk along the section of trail, spotting as many objects as they can. When they reach the end, they whisper to you how many they saw. Invite them to go back and see whether they can spot any that they missed. Be sure to track the objects you have placed and collect them all when the game is finished.

## ◆ NATURE SCAVENGER HUNT

This hunt is intended to test the boys’ knowledge of nature in an exciting competition. It is run like any scavenger hunt—each group of boys gets a list of objects from nature with the goal of finding as many as possible within a given time limit (10 to 20 minutes). Set boundaries for the hunt, and list 20 to 50 objects from nature that boys can find within the area. Objects should be common enough that a Cub Scout can identify most of them. Make sure that boys are marking these items off their list and leaving the items themselves undisturbed. Your list will reflect nature items that can be found in your locale, but here are some common suggestions:

Anthill	Oak leaf	Maple leaf
Dandelion	Insect	Cocoon
Spider web	Animal track	Bird’s nest
Needle from an evergreen	Barrel cactus	Acorn

# BSA OUTDOOR ETHICS PROGRAM

Wilderness conservation depends on understanding and respect for wild places. It also supports the idea that we do not inherit wildlands from previous generations, but instead we are borrowing these places from our children. What we use now—and what we use up now—will be compromised for future generations.

The Boy Scouts of America has long had a commitment to outdoor ethics and conservation practices.

The Cub Scout program includes outdoor stewardship and care for the environment as demonstrated through the BSA's Outdoor Code and the Leave No Trace Principles for Kids. These guiding principles serve as part of an overall program supporting ethical decision making in the outdoors and are an appropriate place to start with Cub Scouts.



## THE OUTDOOR CODE

As an American, I will do my best to—

- ◆ Be clean in my outdoor manners,
- ◆ Be careful with fire,
- ◆ Be considerate in the outdoors, and
- ◆ Be conservation minded.

## LEAVE NO TRACE\* PRINCIPLES FOR KIDS

Know Before You Go  
Choose the Right Path  
Trash Your Trash  
Leave What You Find  
Be Careful With Fire  
Respect Wildlife  
Be Kind to Other Visitors



*\*The member-driven Leave No Trace Center for Outdoor Ethics teaches people how to enjoy the outdoors responsibly. This copyrighted information has been reprinted with permission from the Leave No Trace Center for Outdoor Ethics: [www.LNT.org](http://www.LNT.org).*



BSA resources for Outdoor Ethics are available here:  
[www.scouting.org/outdoorprogram/outdoorethics.aspx](http://www.scouting.org/outdoorprogram/outdoorethics.aspx)



# APPENDIX 6

## RESOURCE GUIDE FOR AQUATICS ACTIVITIES

### WATER SAFETY

Water activities can make good den or pack activities, but safety rules are very important any time a pack is holding an event around water. Some of the boys are probably nonswimmers, and it is likely that some who think of themselves as swimmers can't swim very far or safely in deep water.

To ensure safe aquatics activities, the Boy Scouts of America requires implementation of Safe Swim Defense and Safety Afloat plans whenever Scouting units engage in swimming or boating activities. Swimming or boating activities must be supervised by at least one adult with current training in the appropriate program. That training may be obtained online at [MyScouting.org](http://MyScouting.org) or at various other Scouting venues. (However, training not done online is valid only if the participants are shown the same video viewed online. Those videos are available as items AV-09DVD29 and AV-09DVD02.)

Safe Swim Defense and Safety Afloat provide awareness training of the procedures and skills needed to keep youth safe in and on the water. A conscientious adult who completes the training should learn enough to decide if he or she is sufficiently experienced and well-informed to make appropriate decisions to prevent incidents and to plan for and respond appropriately during emergencies. Additional information to make that assessment is found in the BSA publication *Aquatics Supervision*, No 34346.

*Aquatics Supervision* also serves as the text for *Aquatics Supervision: Swimming and Water Rescue*, and *Aquatics Supervision: Paddle Craft Safety* training. Those two adult training courses teach the skills needed to implement Safe Swim Defense and Safety Afloat procedures in various settings. Each course takes approximately eight hours. Check with your council service center for course offerings.

Leaders may also obtain skilled help to plan and conduct safe aquatics activities by consulting with the local council aquatics committee. Check with your council service center for contact information.



# BSA SAFE SWIM DEFENSE

BSA groups shall use Safe Swim Defense for all swimming activities. Go to [www.scouting.org/OutdoorProgram/Aquatics/safe-swim.aspx](http://www.scouting.org/OutdoorProgram/Aquatics/safe-swim.aspx) for detailed information about the eight principles.

1. Qualified supervision
2. Personal health review
3. Safe area
4. Response personnel (lifeguards)
5. Lookout
6. Ability groups
7. Buddy system
8. Discipline

## HOME SWIMMING POOL SAFETY FOR UNIT EVENTS

All elements of Safe Swim Defense apply at backyard pools even though they may be small, shallow, and familiar. The biggest danger is probably complacency. Adult supervision must be continuous while the pool is in use. A Cub Scout who can't swim can drown silently within 20 seconds of entering water over his head.

*Aquatics Supervision* contains safety information specific to both in-ground and above-ground backyard pools. That includes the following:

- Most such pools are too shallow for diving. Diving prohibition should be discussed at a tailgate review for all participants prior to the activity.
- Beginner and swimmer areas may be combined in small, relatively shallow pools.
- Make sure to control access. Many backyard pools are too small to accommodate an entire pack at once. If other activities are also taking place, it may be best to allow only one den into the water at a time rather than allowing Scouts to move at will in and out of the water.
- Many states require pool fencing, which may help with supervision.
- If the uniform depth of an in-ground pool is too deep for short nonswimmers, they may need properly fitted life jackets.
- Rescues, if needed, should be simple. Provide reaching and throwing devices for active victims. A wading assist may be feasible for passive victims.
- For above-ground pools without decks, have a plan to remove large unresponsive adults who suffer a heart attack or other debilitating condition.

## GUARDED PUBLIC POOLS WITH LIFEGUARDS ON DUTY

*Aquatics Supervision* also covers swimming at public pools, waterparks, and guarded beaches.

Important items include the following:

- Dens and packs do not need to assign and equip rescue personnel. Professionally trained lifeguards provided by the venue satisfy that need.
- Unit leaders are still responsible for medical screening, ability groups, the buddy system, discipline, and supervision.
- Many public pools will have a safety line at the 5-foot mark separating shallow and deep water that can be used to help designate appropriate areas for the different ability groups.
- Otherwise, appoint adult lookouts to make sure nonswimmers and beginners stay in their assigned areas.

Studies show that more than half of victims at public pools are spotted first by others rather than lifeguards. The buddy system is still very important for safety as well as instilling responsibility. It is likely awkward to conduct frequent buddy checks. Therefore, arrange a time for everyone to leave the water and meet at a given location. Then do a head count. Otherwise rely on unit lookouts, buddies, and lifeguards to maintain vigilance. At large waterparks, leaders should accompany dens moving from one feature to another after everyone in the group is accounted for.

## BSA SAFETY AFLOAT (Boating Safety)

BSA groups shall use Safety Afloat for all boating activities. Go to [www.scouting.org/OutdoorProgram/Aquatics/safety-afloat.aspx](http://www.scouting.org/OutdoorProgram/Aquatics/safety-afloat.aspx) for more information on the nine principles.

1. Qualified supervision
2. Personal health review
3. Swimming ability
4. Life jackets
5. Buddy system
6. Skill proficiency
7. Planning
8. Equipment
9. Discipline

### WATER RESCUE

Water rescue training for the lay rescuer often uses a reach, throw, row, go mnemonic to establish a safe, effective sequence for responding to water emergencies. That sequence is important to Cub Scout leaders for two distinct reasons. First it establishes the procedure that response personnel under Safe Swim Defense should follow. If professionally trained lifeguards are not available at a swimming location, then the qualified supervisor has to provide personnel and equipment suitable for likely emergencies. Fortunately, that is often not as difficult as it might first appear. For that reason, a review of the reach, throw, row, and go sequence is appropriate. Important detail can be found in *Aquatics Supervision*.

The other reason for reviewing the sequence is for age-appropriate training of youth. Drowning is the second-leading cause of accidental death for those of Cub Scout age. Therefore, there is a chance that Cub Scouts will be faced with seeing someone in trouble. That possibility is further supported by the Scouts in Action reports in *Boys' Life* magazine. Cub Scouts do save people from drowning.

However, there are also double drownings that occur yearly in the United States when well-meaning people of all ages attempt to save drowning victims. Those are often frantic friends and relatives whose swimming skills are no better than those of the person in trouble. Since Cub Scouts often lack swimming skills and the maturity to realize their limitations, it is important to modify the rescue sequence for Cub Scout training to reach, throw, row, and go for help.

**Reach:** This technique is appropriate to teach Cub Scouts, parents who are nonswimmers, and rescue personnel who are skilled in the water. People who can't swim often begin to struggle immediately after they step into or fall into water over their heads. That is likely to be very close to safety. If so, the rescuer should lie down, reach out, and grab the person. Laying down is necessary since the person in the water will likely stop all effort to remain afloat, and that sudden increase in weight can topple an unprepared rescuer into the water. If the victim is a bit farther out, an extension device such as a pole, paddle, or noodle can be used. Those should be swept to the person from the side, not used like a spear. Victims often cannot reach for an extended item, even if it is just a foot away. Rescuers should therefore be told to place the item under the person's arm or within his grasp. Rescuers should also be told to provide loud, clear, simple instructions to the victim, for example "GRAB THIS!"

**Throw:** The second procedure in the sequence, used when the person is too far out to reach, is to throw the person an aid. A throwing rescue is also appropriate to teach to rescuers of any age and swimming ability. A float with a line attached is best, but any light floating item or a rope by itself may be used. An accurate first toss is required if a line is not attached, but throwing a line takes practice. Ring buoys are often found at hotel and apartment pools and are good devices for Cub Scout practice. Leaders may also fashion throwing devices from light floating line and a plastic jug with just a bit of water in it for weight. A throwing rescue is best suited to poor swimmers in trouble. Drowning nonswimmers will not be able to reach for the object unless it lands within their grasp, nor will passive victims floating face down or on the bottom.

**Row:** A boat can be used to provide a mobile platform from which to do reaching or throwing assists. Since Cub Scouts often do not have the skills needed for a safe rowing rescue, this procedure is not emphasized for that age group. A boat rescue is also not a common part of an emergency action plan for a unit swim since the swimming area is typically small and within easy reach of shore-based response personnel.

**Go:** For Cub Scout training, this item should be interpreted as “go for help.” That is, they should first shout for help, and if no one responds, seek out a responsible person such as a parent, lifeguard, or park ranger. Poor swimmers should not enter the water to attempt a rescue. On the other hand, a unit swim cannot rely on reaching or throwing rescues for emergency planning. An in-water assist will be needed for a parent suffering cardiac arrest in the water. At guarded swims, GO also means going with equipment since lifeguards or response personnel should never be without appropriate rescue aids.

## SWIM CLASSIFICATION TESTS

The following content on swim classification tests is taken from the BSA *Aquatics Supervision* guide.

Safe Swim Defense and Safety Afloat guidelines tailor activities to swimming ability. Therefore, the unit leader needs to provide opportunities for swim classification before aquatics outings. Swim tests conducted by council personnel during or just before summer camp give the unit one way to determine swimming ability. However, not all unit members attend camp, new members may join the unit at any time, and some units plan aquatics activities in lieu of summer camp. Therefore, the unit should be able to safely conduct its own swim tests.

## SWIMMER CLASSIFICATIONS

Scouting recognizes three basic swimming classifications: **swimmer**, **beginner**, and **nonswimmer**. Swim classification tests should be renewed annually, preferably at the beginning of the season.

The **swimmer** test demonstrates the minimum level of swimming ability required for safe deepwater swimming. The various components of the test evaluate several distinct, essential skills necessary for safety in the water. A precise statement of the swimmer test is:

Jump feetfirst into water over the head in depth. Level off and swim 75 yards in a strong manner using one or more of the following strokes: sidestroke, breaststroke, trudgen, or crawl; then swim 25 yards using an easy, resting backstroke. The 100 yards must be completed in one swim without stops and must include at least one sharp turn. After completing the swim, rest by floating.

The test administrator must objectively evaluate both the ease of the overall performance and the purpose of each test element. Any conscientious adult who is familiar with basic swimming strokes and who understands and abides by the following guidelines can administer the test.

**1. "Jump feetfirst into water over the head in depth. Level off . . ."**



The swimmer must be able to make an abrupt entry into deep water and begin swimming without any aids. Walking in from shallow water, easing in from the edge or down a ladder, pushing off from the side or bottom, and gaining forward momentum by diving do not satisfy this requirement. If the swimming area available for the test is not quite over the swimmer's head in depth, or does not provide a platform for jumping into deep water, then a person may be provisionally classified as a swimmer if able to easily bob repeatedly up and down in the water, then level off and begin swimming. The head must submerge without the legs touching bottom. Ideally, the feetfirst entry should be tested at the next available opportunity.

**2. "... swim 75 yards in a strong manner . . ."**



The swimmer must be able to cover distance with a strong, confident stroke. The 75 yards is not the expected upper limit of the swimmer's ability. The distance should be covered in a manner that indicates sufficient skill and stamina for the swimmer to continue to swim for greater distances. Strokes repeatedly interrupted and restarted are not sufficient. The sidestroke, breaststroke, or any strong over-arm stroke, including the back crawl, are allowed in any combination; dog paddling and underwater strokes are not acceptable. The strokes need to be executed in a strong manner, but perfect form is not necessary. If it is apparent that the swimmer is being

worn out by a poorly executed, head-up crawl, it is appropriate for the test administrator to suggest a change to a more restful stroke. A skilled, confident swimmer should be able to complete the distance with energy to spare, even if not in top physical condition. There should be little concern if a swimmer is out of breath because the distance was intentionally covered at a fast pace. However, a swimmer who barely has the energy to complete the distance will benefit from additional skill instruction.

**3. "... swim 25 yards using an easy, resting backstroke."**



The swimmer must demonstrate a restful, free-breathing backstroke that can be used to avoid exhaustion during swimming activity. It is placed at the end of the distance requirement to emphasize the use of the backstroke as a relief from exertion and may actually be used by some swimmers to catch their breath if they swam the first part more strenuously than needed. The change of stroke must be done without support from side or bottom. Any effective variation of the elementary backstroke is acceptable. The form need not be perfect. For example, a modified scissors kick may be substituted for a whip kick. Restful strokes are

emphasized in Scouting as important safety skills that can be used whenever the swimmer becomes exhausted or injured. Some swimmers, particularly current or former members of competitive swim teams, may not be familiar with the elementary backstroke. A back crawl will suffice for the test if it clearly provides opportunity for the swimmer to rest and catch the breath. However, individuals successfully completing the test with the back crawl should be encouraged to learn the elementary backstroke.

**4. "The 100 yards must be completed in one swim without stops and must include at least one sharp turn."**



The total distance is to be covered without rest stops. It is acceptable for someone to float momentarily to work out a kink in a muscle or to tread water to avoid collision with another swimmer, but not to make up for a poorly executed stroke by repeatedly floating, grasping the side, or touching the bottom. The sharp turn demonstrates the important skill of reversing direction in deep water without support. There is no time limit for completion of the test.

**5. "After completing the swim, rest by floating."**



This critically important component evaluates the swimmers' ability to support themselves indefinitely in warm water when exhausted or otherwise unable to continue swimming. Treading water will tire the swimmer and is therefore unacceptable. The duration of the float is not significant, except that it should be long enough for the administrator to determine that the swimmer is in fact resting and could continue to do so. A back float with the face out of the water is preferred, but restful facedown floating is acceptable. If the test is

completed except for the floating requirement, the swimmer may be retested on the floating only (after instruction), provided the test administrator is confident that the swimmer can initiate the float in deep water when exhausted.

A precise statement of the **beginner** test is:

Jump feetfirst into water over the head in depth, level off, and swim 25 feet on the surface. Stop, turn sharply, resume swimming and return to the starting place.

The entry and turn serve the same purpose as in the swimmer test. The swimming may be done with any surface stroke. Underwater swimming is not allowed. The stop assures that the swimmer can regain the stroke if it is interrupted. The test demonstrates that the beginner swimmer is ready to learn deepwater skills and has the minimum ability required for safe swimming in a confined area in which shallow water, sides, or other support is less than 25 feet from any point on the water.

Anyone who has not completed either the beginner or the swimmer test is classified as a **nonswimmer**. The title is descriptive and nonjudgmental. It may represent those just learning to swim who do not yet have the skills to safely venture beyond shallow water. It may also apply to those who have not yet been tested or who have elected to forego the test and to accept the limitations on activities imposed by the classification.

Both nonswimmer and beginner classifications prevent a Scout from gaining the full benefit of aquatics programming. Unit leaders should promote swimming ability to all members and strive to have everyone in the unit classified as swimmers. Such a goal increases each Scout's safety and confidence, provides more recreational and instructional opportunities, and makes it easy for units to administer their own aquatics programs. Note that the beginner test is a requirement for Boy Scout Second Class rank, whereas the swimmer test is a requirement for First Class rank. A unit's ability to conduct swim classification tests also makes it easier to administer rank advancement.

## TESTING PROCEDURE

### Beginners:

- ✓ Jump into deep water.
- ✓ Swim 25 feet.
- ✓ Turn.
- ✓ Return.
- ✓ Total: **50 feet** with entry and turn

### Swimmers:

- ✓ Jump into deep water.
- ✓ Swim 75 yards with strong forward stroke.
- ✓ Swim 25 yards with restful backstroke.
- ✓ Rest by floating.
- ✓ Total: **100 yards** with entry and turn

All swimming activities, including swim classification tests, follow the elements of Safe Swim Defense. The health history of each individual should be reviewed before testing. No one should be allowed in the water against the recommendations of parents, guardian, or physician. Those who are not allowed to enter the water for whatever reason do not automatically fall into the nonswimmer category. Normally, nonswimmers are encouraged to participate in aquatics activities as an incentive to improve their skills. If the aquatics activities are conducted by the unit, then the adult in charge of the event should know the difference between those classified as nonswimmers on the basis of skill, and those not allowed to swim due to a chronic or temporary physical condition that limits water contact. The unit may be asked to conduct swim classification tests before



Swim tests are done one-on-one, with the examiner and youth as buddies.

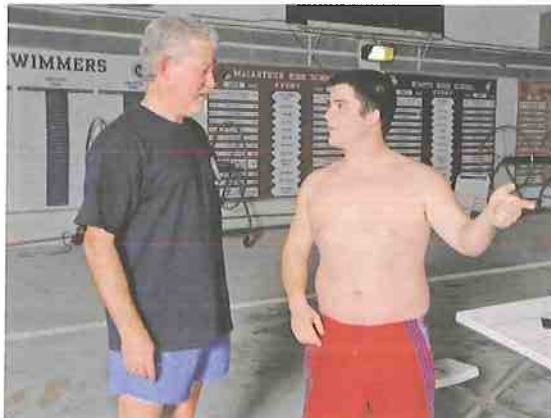

Participant is asked to describe test and confirm comfort with each task. If there is any hesitation, check ability first in shallow water.

participation in a multiple-unit event, such as summer camp or jamboree. In those cases, care should be taken to preclude participation in an event as a nonswimmer by someone who should not be in the water. The unit leader should discreetly communicate such situations to the event supervisor. The youth should be privately put on his honor not to circumvent any restrictions.

Situations may arise when special consideration should be given to those with temporary medical conditions. For example, yearly swim classification renewals may be scheduled just before a canoe trip. A physician may approve a person with an ear infection or a sutured wound to go on the trip, but caution against submerging the head or the bandage. Since it would be difficult to administer the swim test without getting the ears or the wound wet, the adult leader might classify the Scout temporarily as a nonswimmer. That, however, would prevent the Scout from paddling in a canoe with his buddy. If the unit leader has sufficient evidence that the Scout is indeed a good swimmer—he has earned the Lifesaving merit badge, for example, or is a member of a swim team—then an extension of the Scout's previous swimmer classification is appropriate until he heals sufficiently to retake the test.

The ideal place to conduct a swim test is a swimming pool with straight stretches of 25 to 50 yards and clear water at least 7 feet deep at the point of entry. Those taking the swimmer test can then be instructed simply to swim either four or two lengths as appropriate. A pool 25 or 50 meters in length is easily adapted by placing a turning mark or line at the yard mark, or by having the person swim the short extra distance. (Recall that the swimmer test is not meant to demonstrate the maximum distance a person can swim.) The course may also be laid out such that the swimmer follows a circular pattern around the pool rather than back and forth, but be sure to incorporate the sharp turn required by both beginner and swimmer tests.

Very small backyard or apartment pools (less than roughly 20 feet in the maximum direction) are fine for a unit swim, but should be avoided as locations for swim classification tests since likely contact with the sides and bottom during all the turns makes it difficult to judge how well the person can swim. Such pools may also be too shallow to meet the criterion for a feetfirst entry into water over the head in depth.

Any natural body of water that satisfies Safe Swim Defense requirements may be used for swim classification tests. Clear water is preferred over murky water; warm water over cold water. A pier that extends from shore to deep water is ideal for the feetfirst entry in the requirements, but a floating platform can also be used.

If a pool open to the public is used for testing, try to schedule a time when the pool is less crowded. Inform pool personnel of what you are doing. A guard may be willing to clear an area briefly if you have only one or two Scouts who need the test.

During swim classification tests, the swimmer and the test administrator form a buddy pair. If there is a large group needing tests, then several testers are useful. Individual testing is required. Unit members should not be aligned at each lane and started at once, as in a swim competition.

Although the tests may be explained to the unit as a whole, the test administrators should briefly review the tests with each participant. Each person should be asked if he or she would like to first try the beginner or the swimmer test. If the person asserts the ability to easily swim 100 yards, then it is not necessary to take the beginner test before the swimmer test. If a person is hesitant, he may take the beginner test first and follow it with the swimmer test if that seems appropriate. Those who fall just short of the required distances may be given a few pointers, a rest, and another try. Those who cannot complete the tests should be congratulated on how far they got, encouraged to practice, and told that they will be able to retake the test at a later date. If a person in a swimsuit at the swimming area decides not to take either test,

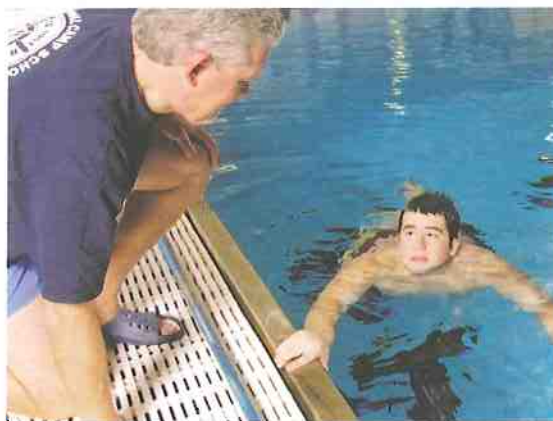

Tests measure comfort in the water but do not require perfect form.



Rest stops are not allowed. However, the course should be close to the side to allow for resting and easy assists if needed.

then he should be encouraged to slip into shallow water and show what he does know. That is, professed nonswimmers should be part of the overall unit activity, not shunted aside in the interest of time. Everyone should be encouraged to try to swim to the best of their ability, but no one should be coerced into the water.

Some participants may be willing to jump into water over their head even though they have never done it. Therefore, every participant should be asked if they have jumped into deep water before. If they have not, first confirm that they can swim in shallow water and then see if they are comfortable in deep water with a slide-in entry at the edge. The test may proceed once the person demonstrates comfort in deep water.

With proper screening, those taking the test should not be at risk of a bad experience. Nevertheless, test administrators should be ready and able to provide immediate assistance if the swimmer does need help, perhaps due to a cramp or exhaustion. Ideally, the course for the beginner test should be alongside a pool deck or pier so that the swimmer is always within a hand's reach or a single stroke from support. The course for the swimmer test should be within reach of a pole. The best way to keep poles ready for use is to lay them along the edge of the pool or pier. A pole is then within easy, unobtrusive access at all times. If the course incorporates a floating dock in a natural body of water, then the feetfirst entry and first few strokes should be within easy reach. If the course then extends beyond the reach of a pole, the swimmers should be either within reach of rescue personnel in a rowboat or canoe or within easy throwing distance of a ring buoy on a line or a throw bag. If a person taking the test succeeds in leveling off after the feetfirst jump, then the most likely need will be to encourage a tired swimmer to come to the side under their own power. In a few cases, a reaching assist may be needed immediately after the feetfirst entry. Test administrators should be skilled in basic rescue techniques to satisfy Safe Swim Defense guidelines for trained safety personnel. If there are others in the water not taking part in the testing, then additional response personnel (lifeguards) are needed. In either case, a lookout is required to monitor all in-water activity.

## SWIM TEST ANXIETY

Both the unit leader and the test administrator should be sensitive to those who may be fearful of the water, uncertain of their ability, worried about peer reaction, otherwise apprehensive, or simply confused about the process and what is expected of them. The unit leader should work with the test administrator to help prepare such Scouts for the swim test, particularly when it is conducted by someone the Scout is unfamiliar with, such as staff at resident camp or at a multiunit, council-organized swim test prior to camp.

The first day of a camp program may be an overwhelming experience for Scouts for many reasons—being away from home and the support systems that home provides, the thrill but uncertainty of what they will experience at camp, and perhaps thoughts of how they will measure up in comparison to their buddies. At summer camps, the swim test is often the first program activity where Scouts both interact significantly with those outside the unit and are asked to perform to a standard. That experience may produce significant anxiety for a small number of boys. However, there is no justification for fears to be realized. The unit leader can help prepare those Scouts both before and at camp so that the swim test is a positive experience. The following items should help leaders recognize and reduce anxiety about the testing process:

- **Early identification.** Scouts who may be anxious around the water or with the swim test process should be identified well before summer camp or other event for which the test is required. Comfort around the water should be included in the leader's discussion with parents for boys who join the unit. The leader should also talk to the boys themselves. For Cub Scouts, check to see if swimming is an interest. For Boy Scouts, comfort in the water should arise naturally during discussions of advancement requirements for Second Class, which includes the beginner test, and for First Class, which includes the swimmer test. Be sure to watch for nonverbal cues to see if the boy's body language matches what he says.
- **Year-round swimming programs.** A year-round swimming program provides meaningful and fun activities and allows the leader to observe firsthand the comfort level of Scouts around the water. It also provides an opportunity to see how unit members respond to those reluctant around the water or with lesser swimming ability. For troops, it will help move Boy Scout advancement along faster. Ideally, the first time the Scout takes a swim test is during a learn-to-swim class with a familiar, trusted instructor conducting the exercise. Subsequent tests are just repeats of tasks the boy knows he has accomplished before.



- **Consider precamp swim tests.** Some councils arrange precamp swim tests for units. If that option is available, consider whether boys with swim test anxiety might perform better away from the other first-day camp activities. If allowed, reluctant members of the unit might arrive early to get adjusted to the water and take a “mock” test prior to the “real” test. (Note that the camp aquatics director may retest any Scout or leader whose skills appear inconsistent with their classification.)
- **Prepare the unit for the test.** The leader should familiarize Scouts with the swim test process as part of the unit’s camp readiness discussions. Explain the purpose of the test and how it will be conducted. Explain that each boy’s swimming ability may be different and that the better swimmers are expected to encourage and support those with lesser ability. Remind everyone that opportunities to retake the test will be provided to those who don’t make it as far as they would have liked. Encourage any boy who needs to speak with the leader in private to do so. And remember that no one should be forced—whether by anyone’s statement or through peer pressure—to take either test if they choose not to.
- **Work with the camp aquatics director.** The camp aquatics director should approach the unit leader when the unit arrives at the swimming area for orientation before the test. That is an intentional opportunity for the leader to identify any medical concerns and to discuss any boys who may be anxious about the swim test. Make sure the aquatics director assigns an empathetic, experienced staff member to work with each such boy and stay with the boy until the staff member establishes a reasonable rapport. The tests will be conducted one-on-one, so it should be possible for leaders to stagger interactions with more than one Scout. If the Scout remains anxious, the leader may request the aquatics director to arrange a special time to conduct the test for that individual when there is less activity in the area and more time for the boy to become comfortable before taking the test.

# APPENDIX 7

## LEADER HELPS

### KNOTS AND ROPES

#### ◆ WHIPPING A ROPE

Ropes are made of twisted fibers. When a rope is cut, the fibers separate. You can whip the ends in place with string so the rope won't unravel.



Cut off the part that has already unraveled. Take a piece of strong string, dental floss, or thin twine at least 8 to 10 inches long. Make a loop and place it at one end of the rope.

Wrap the string tightly around the rope. When the whipping is as wide as the rope is thick, slip the end through the loop. Then firmly pull out the string ends and trim them off.

#### ◆ FUSING A ROPE

Rope and cord made of plastic or nylon will melt when exposed to high heat. Cut away the frayed part of the rope. Then, working in a well-ventilated area, hold each end a few inches above a lighted match or candle to melt and fuse the strands together. Melted rope can be hot and sticky—don't touch the end until it has cooled. Do not try to fuse ropes made of maila, sisal, hemp, cotton, or other natural fibers, because they will burn rather than melt.



#### ◆ KNOTS FOR CAMPING

You will use rope for many purposes when you go camping. These knots will come in handy for different situations.

1. **Square Knot:** For tying two ropes together and for tying bandages in first aid.

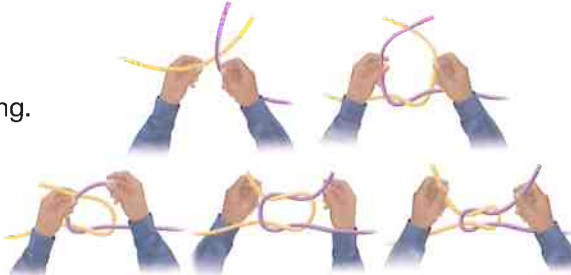

2. **Taut-line Hitch:** For tightening and loosening a rope easily and for use on tent guy lines. Tighten or loosen the knot by pushing the hitch up or down.



3. **Two Half Hitches:** For tying a rope to a post or ring. This knot is strong but is easy to loosen.

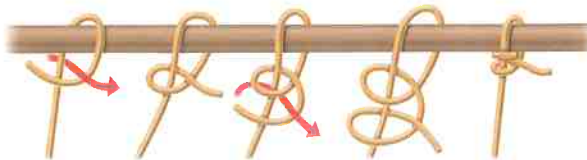

4. **Bowline:** Used when you want a loop that will not slip or close up. It is often used in rescue work.

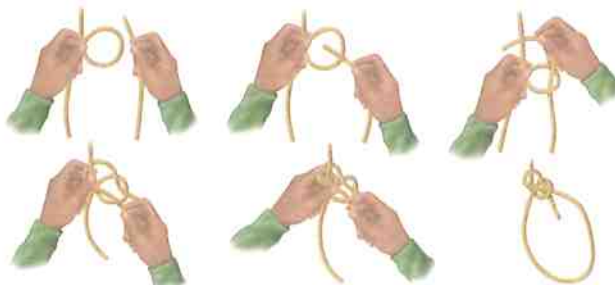

# APPENDIX 8

## AWARDS

### AWARDS CUB SCOUTS CAN EARN

The following awards can be earned by Cub Scouts. Visit [Scouting.org](http://Scouting.org) to learn more about each individual award and to find current requirements.

#### ◆ CONSERVATION GOOD TURN AWARD

The Conservation Good Turn is an award packs may earn by partnering with a conservation or environmental organization to choose and carry out a Good Turn in their home communities.



#### ◆ OUTDOOR ACTIVITY AWARD

Tiger, Wolf, Bear, and Webelos Scouts have the opportunity to earn the Cub Scout Outdoor Activity Award. Scouts may earn the award in each of the program years as long as the requirements are completed again each year. Cub Scouts complete specific requirements for each rank, including a number of different outdoor activities.



#### ◆ NATIONAL SUMMERTIME PACK AWARD

The National Summertime Pack Award encourages packs to be active when school is out for the summer. Youth and adult pack members can earn the award by taking part in one activity per month in June, July, and August.



#### ◆ OUTDOOR ETHICS AWARENESS AWARD AND OUTDOOR ETHICS ACTION AWARD

Cub Scouts who are interested in learning more about outdoor ethics and Leave No Trace may earn the Outdoor Ethics Awareness Award. The Outdoor Ethics Action Award asks Scouts to use their new knowledge to take steps to improve their outdoor skills.



## ◆ SCOUTSTRONG HEALTHY UNIT AWARD

When a Scout recites the Scout Oath and Law, he promises to keep his mind and body fit. Help Cub Scouts in your den keep that promise by following three healthy practices at all meetings and gatherings: drink right, move more, and snack smart. Your den can earn the SCOUTStrong Healthy Unit Award by fulfilling the following requirements during meeting times:

**Drink right:** Make water the main beverage (6 meetings).

**Move more:** Include 15 minutes of fun physical activity (9 meetings).

**Snack smart:** Serve fruits or vegetables, when snacks are provided (3 meetings).

When Scouts achieve and wear the SCOUTStrong Healthy Unit Award, they're creating a standard for meetings. This builds a healthy Scouting experience that can establish lifelong habits. Plus, activities for the award match many advancement requirements. Find a tracker to record your den's progress toward this award and additional resources at [Scouting.org](http://Scouting.org).



## ◆ STEM/NOVA AWARDS

The Nova awards for Cub Scouts are for Wolf, Bear, and Webelos Scouts who are interested in learning more about science, technology, engineering, and mathematics. These awards may not be earned by Tigers.

For their first Nova awards, Scouts have the opportunity to earn the Nova award patch, followed by three more  $\pi$  pin-on devices. The patch and the three devices represent each of the four STEM topics. The Supernova awards have more challenging requirements and recognize more in-depth, advanced achievement in STEM-related activities.



## ◆ WORLD CONSERVATION AWARD

The World Conservation Award for Cub Scouts provides an opportunity for individual Wolf, Bear, and Webelos Scouts to “think globally” and “act locally” to preserve and improve our environment. This program is designed to make youth members aware that all nations are closely related through natural resources, and that we are interdependent with our world environment.

Requirements for this award must be completed *in addition to* any similar requirements completed for rank. This award may not be earned by Tigers.



# APPENDIX 9

## ADDITIONAL RESOURCES

### RESOURCES, FORMS, AND APPLICATIONS

\* Items with an asterisk are available at [www.scouting.org/cubscouts](http://www.scouting.org/cubscouts).

† Items with a dagger symbol are available at [www.scoutstuff.org](http://www.scoutstuff.org) or at your local Scout shop.

★ Items with a star are available at [www.myscouting.org](http://www.myscouting.org) or through local council training.

#### ◆ DEN AND PACK MANAGEMENT

Annual BSA Health and Medical Record, No. 680-001 \*

Cub Scout Den Record \*

*Cub Scout Leader Book*, No. 33221 †

*Den Chief Handbook*, No. 33211 †

Individual Cub Scout Record \*

Meeting Place Inspection Checklist \*

Monthly Den Dues Envelope, No. 34209 †

Pack Overnighter Site Approval Form, No. 13-508 \*

*Pack Record Book*, No. 33819 †

Webelos Den Record \*

#### ◆ UNIFORMING

Adult Leader Uniform Inspection Sheet, No. 34048 \*†

Cub Scout Leader Training Poster Set, No. 34876 †

*Cub Scout Leader Specific Training Video*, AV01-V013 ★

*Guide to Awards and Insignia*, No. 33066 †

Tiger, Wolf, and Bear Uniform Inspection Sheet, No. 34282 \*†

Webelos Scout Uniform Inspection Sheet, No. 34635 \*†

#### ◆ TRAINING

BALOO (Basic Adult Leader Outdoor Orientation), No. 34162 ★

Cub Scout Fast Start ★

Cub Scout Leader Specific Training, No. 34875 ★

Cub Scout Leader Training Poster Set, No. 34876 †

*Cub Scout/Boy Scout Fast Start Training DVD*, AV-01DVD22 †

How Do I Rate as an Effective Leader? \*

Safe Swim Defense, No. 34370 †★

*This Is Scouting*, No. 36118 \*†★

## ◆ MEMBERSHIP RECRUITING AND LEADERSHIP SELECTION

Adult Registration Application, No. 524-501; in Spanish, No. 524-502 \*†

Cub Scouting and Your Family, No. 34362 \*

Family Talent Survey Sheet \*

Family Information Letter Samples (5) \*

Leadership Transfer Notice, No. 28-401 \*

Selecting Cub Scout Leadership, No. 522-500 \*

Youth Application, No. 524-406; in Spanish, No. 524-423 \*

## ◆ ADVANCEMENT

Advancement Report, No. 34403 \*†

Arrow of Light Pocket Certificate, No. 34219 †

Bear (Den) Advancement Chart, No. 34191

Bear Pocket Certificate, No. 34221 †

*Bear Handbook*, No. 33451 †

Bobcat Pocket Certificate, No. 34218 †

Cub Scout Cycle, No. 13-027 \*

Cub Scout Insignia Stickers—Large, No. 34650 †

Den Advancement Report \*

Pack Graduation Certificate, No. 33751 †

*Tiger Handbook*, No. 34713 †

Tiger Pocket Certificate, No. 34714

*Webelos Handbook*, No. 33452 †

Webelos Scout (Den) Advancement Chart, No. 34187 †

Wolf (Den) Advancement Chart, No. 34182

*Wolf Handbook*, No. 33450 †

Wolf Pocket Certificate, No. 34220 †

## ◆ PROGRAM PLANNING

*BALOO (Basic Adult Leader Outdoor Orientation)*, No. 34162 †★

BSA Cub Scout World Conservation Award \*

Buddy Tags, No. 1595 †

Campfire Program Planner \*

Climb On Safely, No. 430-099 \*†★

*Cub Scout Ceremonies for Dens and Packs*, No. 33212 †

*Cub Scout Day Camp Administration Guide*, No. 430-338 \*

Cub Scout Den Meeting Program \*

*Cub Scout Grand Prix Pinewood Derby Guidebook*, No. 33721 †

Cub Scouting's Outdoor Ethics Award \*

*Cub Scout Leader How-To Book*, No. 33832 †  
*Cub Scout Magic*, No. 33210 †  
Cub Scout Outdoor Activity Award \*  
*Cub Scout Songbook*, No. 33222 †  
Cub Scout/Webelos Scout Outdoor Program Guide \*†  
*Den Chief Handbook*, No. 33211 †  
*Fun for the Family*, No. 33012 †  
*Group Meeting Sparklers*, No. 33122 †  
*Guide to Safe Scouting*, No. 34416 \*†  
Individual Campout Checklist for Pack Overnigher \*  
Informed Consent Form (Permission Slip) \*  
*National Camp Standards*, No. 430-056  
National Den Award \*  
National Summertime Pack Award, No. 33748 \*†  
Outdoor Code Poster (big prints), No. 33689 †  
Pack Meeting Planning Sheet \*  
Pack Meeting Plans \*  
Pack Program Planning Chart, No. 26-004 \*  
*Resident Camping for Cub Scouts, Webelos Scouts, and Parents*, No. 13-33814 \*  
Safe Swim Defense, No. 34370 †  
Tour Planning Checklist, No. 680-014 \*  
Unit Money-Earning Application, No. 34427 \*†  
Webelos Den Meeting Program, No. 33852 \*  
Webelos Scout Overnight Checklist \*  
*Your Flag*, No. 33188 †

## ◆ **RECOGNITION**

Assistant Denner Shoulder Cord, No. 385 †  
Den Chief Badge of Office (cloth), No. 387 †  
Den Chief Service Award (certificate), No. 33726 †  
Den Chief Service Award (shoulder cord), No. 389 †  
Den Chief Shoulder Cord, No. 388 †  
Denner Shoulder Cord, No. 368 †  
National Den Award Ribbon, No. 17631 †  
National Summertime Pack Award pins:  
    Tiger National Summertime Award pin, No. 14332 †  
    Wolf National Summertime Award pin, No. 14333 †  
    Bear National Summertime Award pin, No. 14334 †  
    Webelos National Summertime Award pin, No. 14335 †

# NOTES



# NOTES

# NOTES

# NOTES

# NOTES

# NOTES

# NOTES

# Official Placement of Insignia

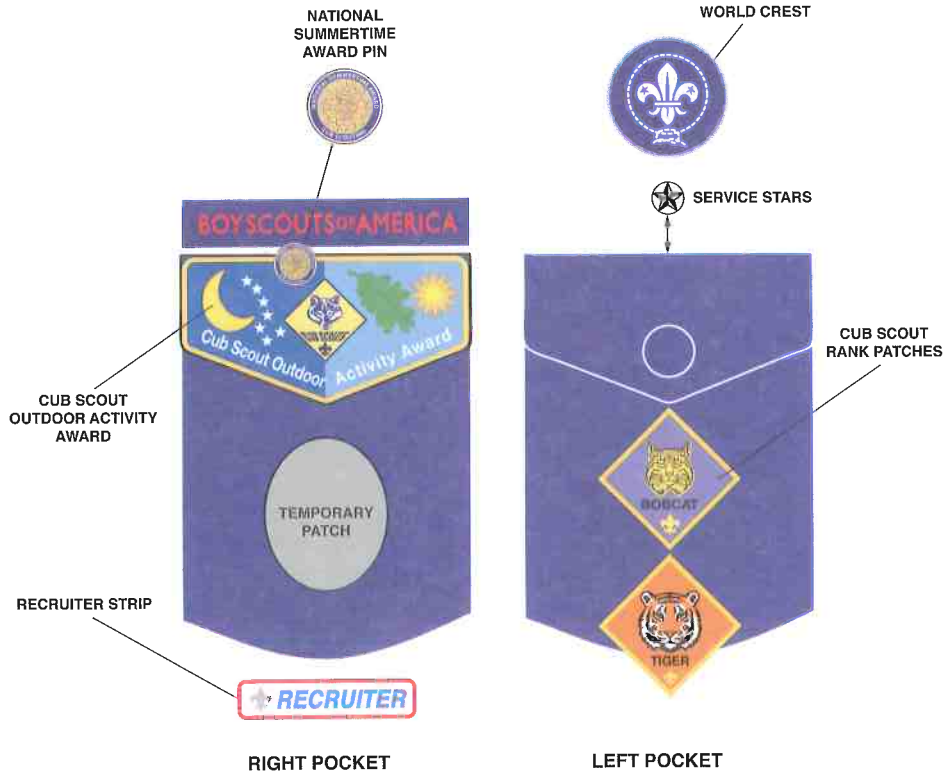

# SCOUT OATH

---

On my honor I will do my best  
To do my duty to God and my country  
and to obey the Scout Law;  
To help other people at all times;  
To keep myself physically strong,  
mentally awake, and morally straight.

# SCOUT LAW

---

Trustworthy  
Loyal  
Helpful  
Friendly  
Courteous  
Kind  
Obedient  
Cheerful  
Thrifty  
Brave  
Clean  
Reverent



BOY SCOUTS OF AMERICA  
1325 West Walnut Hill Lane  
P.O. Box 152079  
Irving, Texas 75015-2079  
<http://www.scouting.org>

SKU 620485



37002

2015 Printing